

MATERIAL NO.	ENG. NO.	STUD SIZE	"S" MAX	DESCRIPTION
192030495	C-S-130-14	1/4	.259/6.58	LOOSE
192030095	C-S-130-14T	1/4	.259/6.58	TAPE

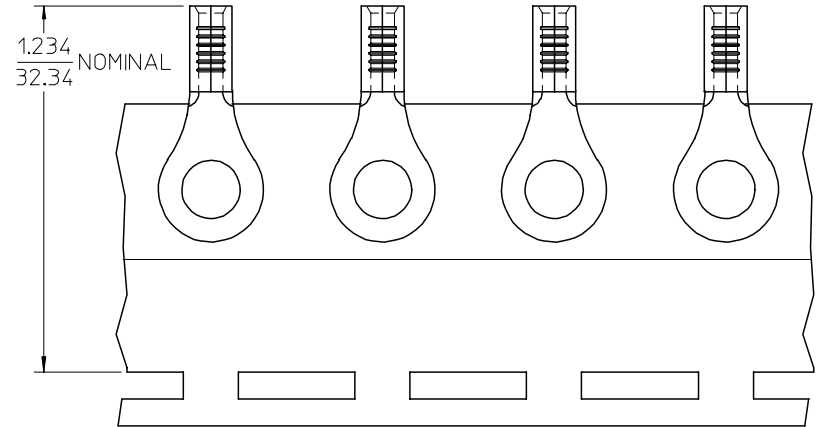
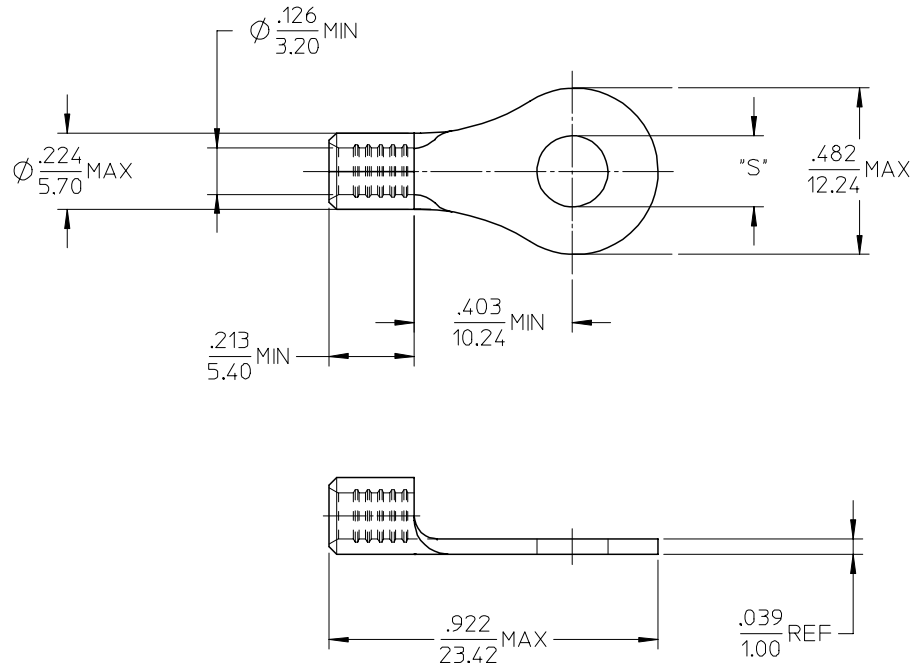

PARTS ON TAPE

NOTE(S):

- MATERIAL: STEEL
- WIRE SIZE: 12-10 AWG (4.0-6.0 MM²)
- FINISH: NICKEL PLATING
- PART IS ROHS COMPLIANT.
- AMBIENT OPERATING TEMPERATURE UP TO 900 °F (483 °C).

REV	DESCRIPTION	QUALITY SYMBOLS	GENERAL TOLERANCES (UNLESS SPECIFIED)		DIMENSION STYLE	SCALE	DESIGN UNITS	THIRD ANGLE PROJECTION
			mm	INCH	IN/MM	4:1	INCH	
B	ADDED OPERATING TEMP EC NO: ETC2007-0297 DRW: NEHLE 2007/03/13 CHKD: JMACNEIL 2007/03/13 APPR: JMACNEIL 2007/03/14	$\nabla=0$ $\nabla=0$	4 PLACES	± ---	± ---	DRAWN BY EHILE	DATE 2006/09/22	TITLE RING TONGUE TERMINAL, 12-10 AWG, KRIMPTITE, 900 DEG F (483 DEG C)
			3 PLACES	± ---	± ---	CHECKED BY JMACNEIL	DATE 2006/09/22	
			2 PLACES	± ---	± ---	APPROVED BY JMACNEIL	DATE 2006/09/22	MOLEX INCORPORATED
			1 PLACE	± ---	± ---	MATERIAL NO. SEE CHART	DOCUMENT NO. SD-19203-033	
			DRAFT WHERE APPLICABLE MUST REMAIN WITHIN DIMENSIONS		ANGULAR	THIS DRAWING CONTAINS INFORMATION THAT IS PROPRIETARY TO MOLEX INCORPORATED AND SHOULD NOT BE USED WITHOUT WRITTEN PERMISSION		SHEET NO. 1 OF 1