

# Analog Devices Welcomes Hittite Microwave Corporation

NO CONTENT ON THE ATTACHED DOCUMENT HAS CHANGED



**THIS PAGE INTENTIONALLY LEFT BLANK**



### Typical Applications

The HMC928LP5E is ideal for:

- EW Receivers
- Military Radar
- Test Equipment
- Satellite Communications
- Beamforming Modules

### Features

- Octave Bandwidth: 2 - 4 GHz
- 450° Phase Shift
- Low Insertion Loss: 3.5 dB
- Low Phase Error: ±5 Typical
- Single Positive Voltage Control
- 32 Lead 5x5 mm SMT Package: 25 mm<sup>2</sup>

### Functional Diagram

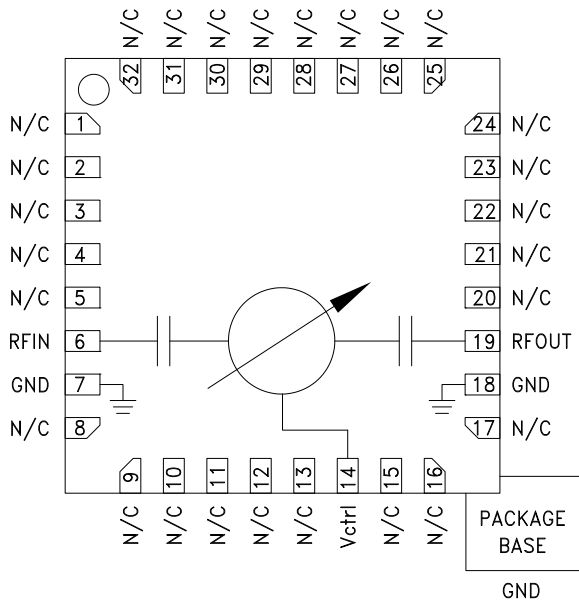

### General Description

The HMC928LP5E is an Analog Phase Shifter which is controlled via an analog control voltage from 0 to +13V. The HMC928LP5E provides a continuously variable phase shift of 0 to 450 degrees from 2 to 4 GHz, with extremely consistent low insertion loss versus phase shift and frequency. The high accuracy HMC928LP5E is monotonic with respect to control voltage and features a typical low phase error of ±5 degrees over an octave bandwidth. The HMC928LP5E is housed in an RoHS compliant 5x5 mm QFN leadless package.

### Electrical Specifications, $T_A = +25^\circ C$ , 50 Ohm System

Parameter	Frequency (GHz)	Min.	Typ.	Max.	Units
Phase Shift Range	2 - 4 GHz		450		deg
Insertion Loss	2 - 4 GHz		3.5		dB
Return Loss (Input & Output)	2 - 4 GHz		15		dB
Control Voltage Range	2 - 4 GHz	0		13	V
Control Current Range	2 - 4 GHz			± 1.0	mA
Maximum Input Power for Linear Operation	2 - 4 GHz			10	dBm
Phase Voltage Sensitivity	2 - 4 GHz		35		deg/V
Phase Error *	2 - 4 GHz		±5		deg
Phase Error (average)	2 - 4 GHz		3		deg
Modulation Bandwidth	2 - 4 GHz		20		MHz
Insertion Phase Temperature Sensitivity	2 - 4 GHz		0.10		deg/°C

\* Up to a phase shift range of 400 degrees.



## 450° ANALOG PHASE SHIFTER, 2 - 4 GHz

**Insertion Loss vs. Frequency**

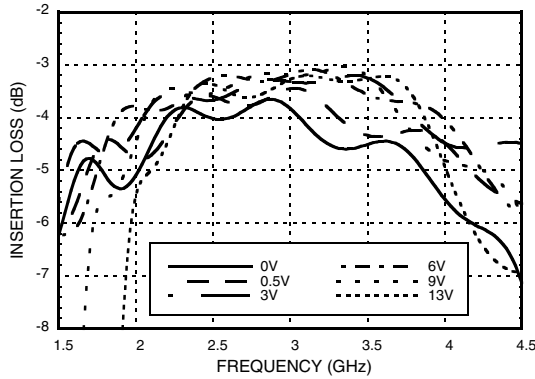

**Insertion Loss vs. Vctl, F = 3 GHz**

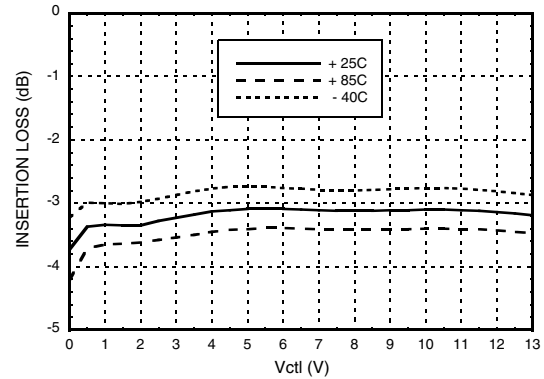

**Phase Shift vs. Vctl**

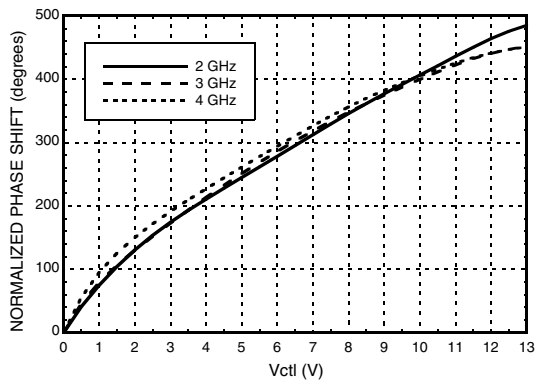

**Phase Shift vs. Frequency @ Vctl = 6V  
(Relative to Vctl = 0V)**

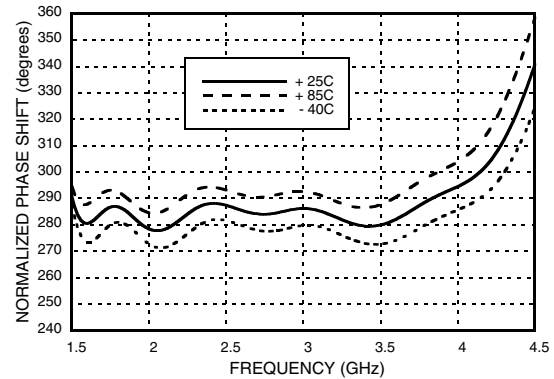

**Phase Shift vs. Frequency  
(Relative to Vctl = 0V) Vctl = 0.5 to 13V**

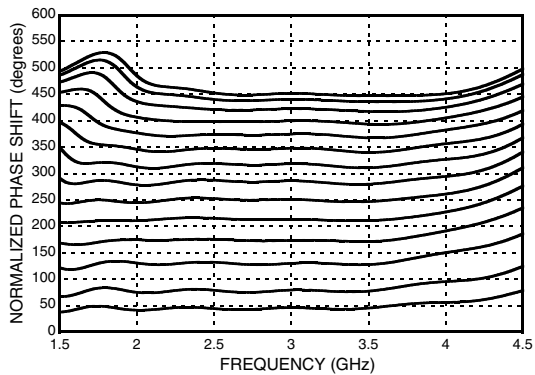

**Phase Error vs. Frequency, Fmean = 3 GHz [1]**

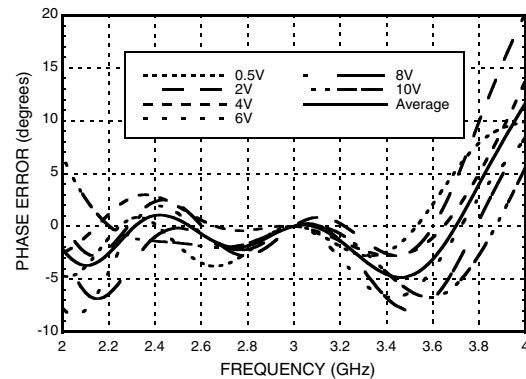

[1] 0 - 10V provides 0 - 400 degrees phase shift range



## 450° ANALOG PHASE SHIFTER, 2 - 4 GHz

**Second Harmonics vs. Vctl, F = 6 GHz**

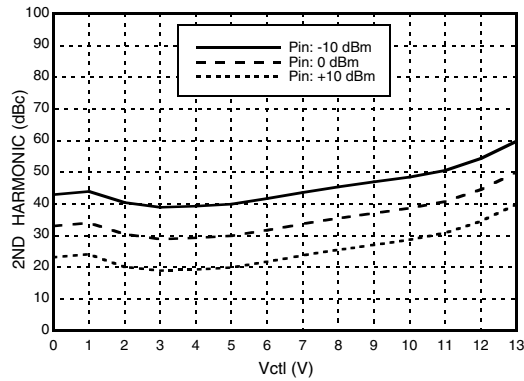

**Third Harmonics vs. Vctl, F = 3 GHz**

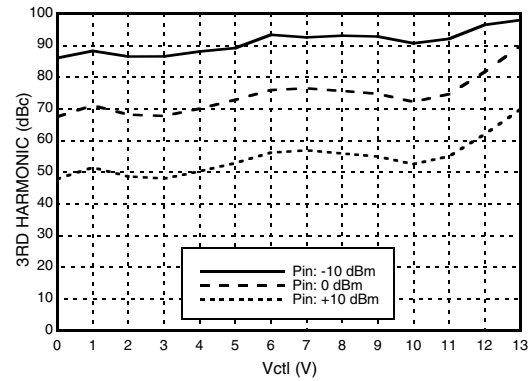

**Input IP3 vs. Vctl, F = 3 GHz**

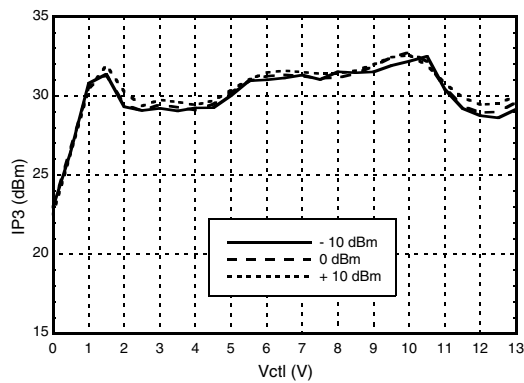

**Insertion Loss vs. Pin @ 2 GHz**

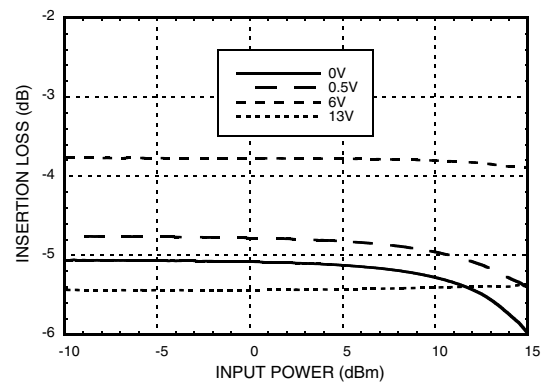

**Insertion Loss vs. Pin @ 3 GHz**

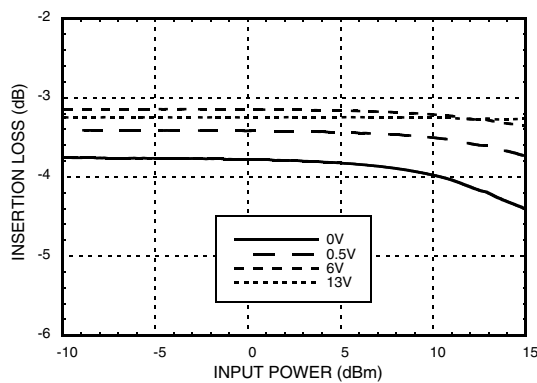

**Insertion Loss vs. Pin @ 4 GHz**

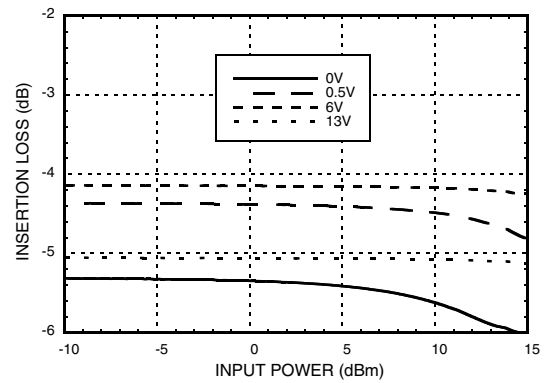

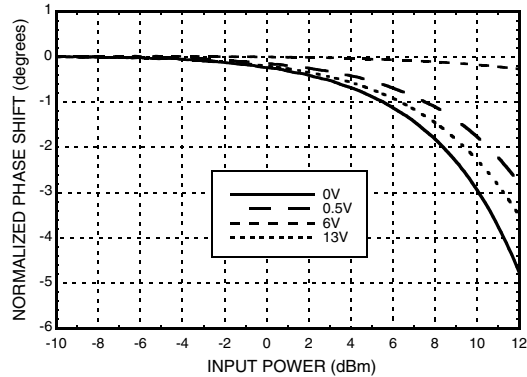
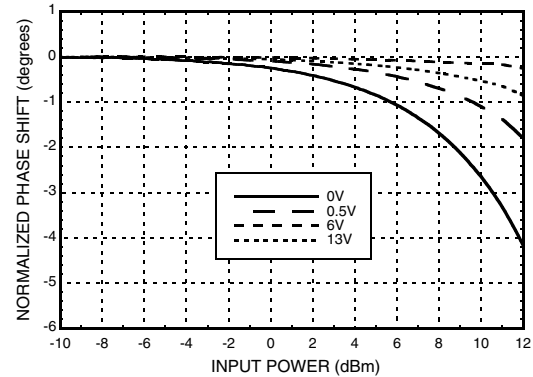
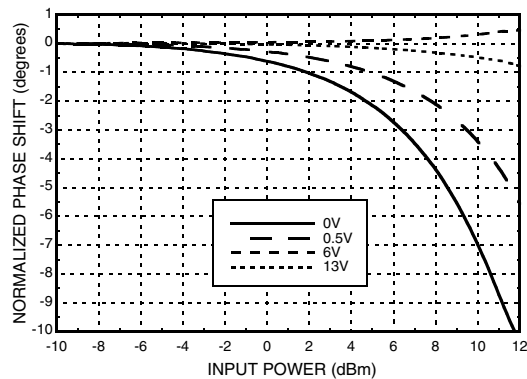
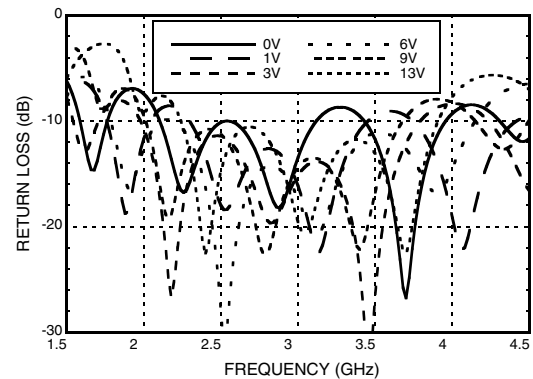
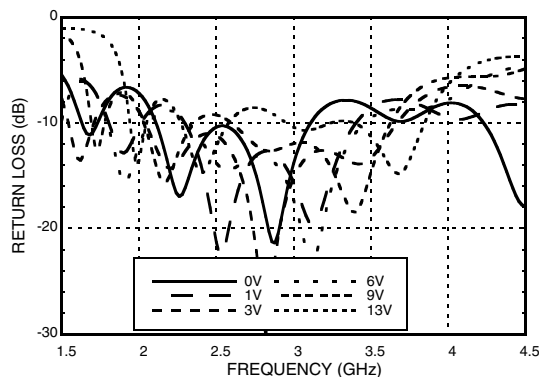

**450° ANALOG PHASE SHIFTER,  
2 - 4 GHz**
**Phase Shift vs. Pin @ 2 GHz**

**Phase Shift vs. Pin @ 3 GHz**

**Phase Shift vs. Pin @ 4 GHz**

**Input Return Loss vs.  
Frequency, Vctl = 0 to +13V**

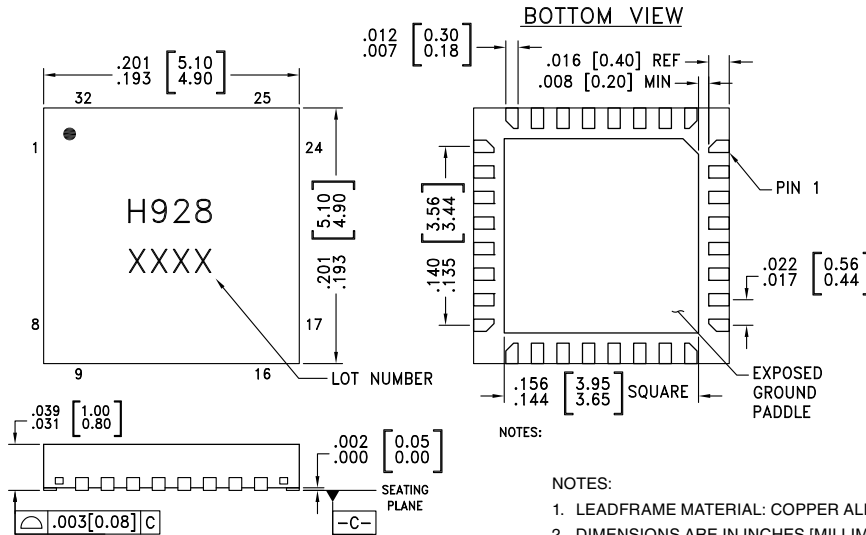
**Output Return Loss vs.  
Frequency, Vctl = 0 to +13V**

**Reliability Information**

Junction Temperature (Tj)	150 °C
Nominal Junction Temperature (T = 85° C and Pin = 10 dBm)	87 °C
Thermal Resistance (Junction to GND paddle)	45 °C/W
Operating Temperature	-40 to +85 °C

**Absolute Maximum Ratings**

Input Power (RFIN)	+27 dBm
Control Voltage (Vctl)	-0.5V to +15V
Storage Temperature	-65 to +150 °C
ESD Sensitivity (HBM)	Class 1B

**ELECTROSTATIC SENSITIVE DEVICE  
OBSERVE HANDLING PRECAUTIONS**

**Outline Drawing**

**Package Information**

Part Number	Package Body Material	Lead Finish	MSL Rating	Package Marking <sup>[1]</sup>
HMC928LP5E	RoHS-compliant Low Stress Injection Molded Plastic	100% matte Sn	MSL1 <sup>[2]</sup>	H928 XXXX

[1] 4-Digit lot number XXXX

[2] Max peak reflow temperature of 260 °C

**Pin Descriptions**

Pin Number	Function	Description	Interface Schematic
1 - 5, 8 - 13, 15 - 17, 20 - 32	N/C	No connection required. These pins may be connected to RF/DC ground without affecting performance.	
6	RFIN	Port is DC blocked.	RFIN ○— —
7, 8	GND	Ground: Backside of package has exposed metal ground slug that must be connected to ground thru a short path. Vias under the device are required.	○ GND   
14	Vctl	Phase shift control pin. Application of a voltage between 0 and 13 volts causes the transmission phase to change. The DC equivalent circuit is a series connected diode and resistor.	Vctl ○—31nH—200Ω— —36pF   16pF   
19	RFOUT	Port is DC blocked.	— —  ○ RFOUT

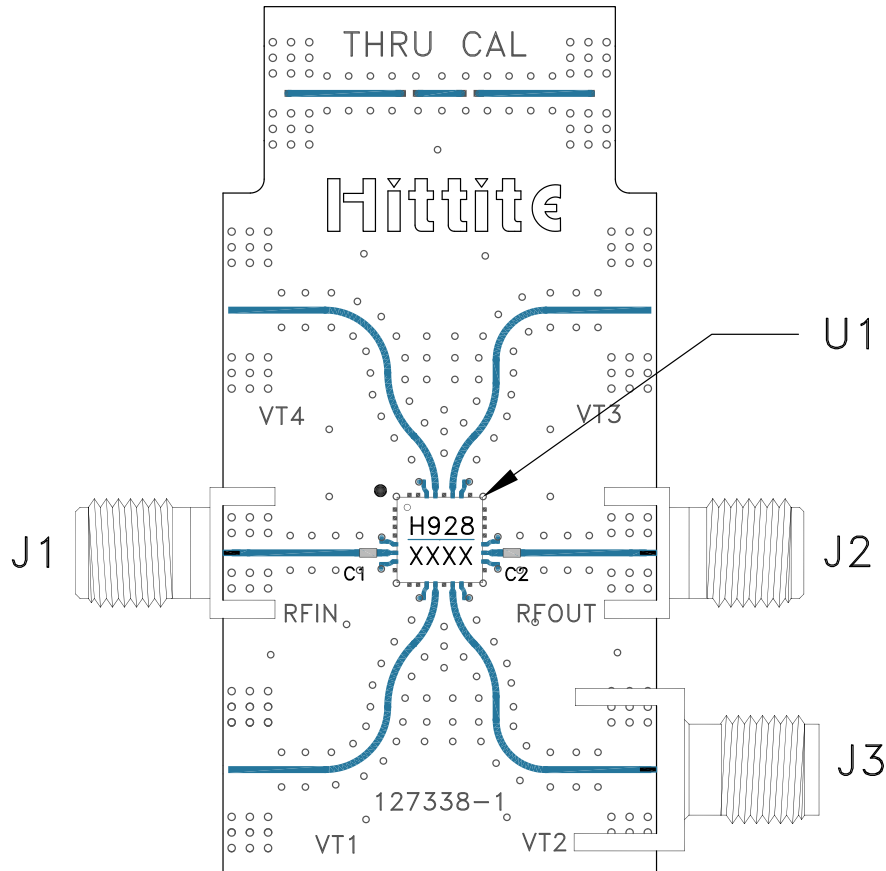
**Evaluation PCB**

**List of Materials for Evaluation PCB 131046 [1]**

Item	Description
J1 - J3	PCB Mount SMA Connector
U1	HMC928LP5E Analog Phase Shifter
C1, C2	Capacitor, 100 pF, 0402 Pkg.
PCB [2]	127338 Evaluation PCB

[1] Reference this number when ordering complete evaluation PCB

[2] Circuit Board Material: Rogers 4350

The circuit board used in the application should use RF circuit design techniques. Signal lines should have 50 Ohm impedance while the package ground leads and exposed paddle should be connected directly to the ground plane similar to that shown. A sufficient number of via holes should be used to connect the top and bottom ground planes. The evaluation board should be mounted to an appropriate heat sink. The evaluation circuit board shown is available from Hittite upon request.