



THIS INFORMATION IS CONFIDENTIAL AND PROPRIETARY TO CW INDUSTRIES INCORPORATED AND ITS AFFILIATES. IT MAY NOT BE DISCLOSED TO ANYONE, OTHER THAN CW INDUSTRIES PERSONNEL, WITHOUT WRITTEN AUTHORIZATION FROM CW INDUSTRIES INCORPORATED, SOUTHAMPTON, PENNSYLVANIA USA.

<b>Rating</b>	12(4)A 250V ac   US	<b>Mounting Hole</b>	<b>Circuit Diagram</b>
<b>Contact Resistance</b>	50m ohm Max.		
<b>Insulation Resistance</b>	DC 500V 100M ohm Min.		
<b>Dielectric Strength</b>	AC 1500V 1 minute		
<b>Switch Function</b>	6P DPDT ON-ON		
<b>Operation Temperature</b>	0°0~85°C		

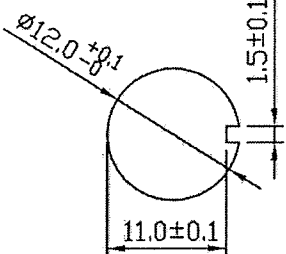
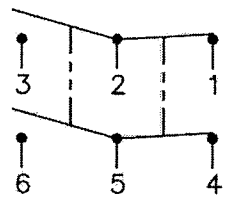
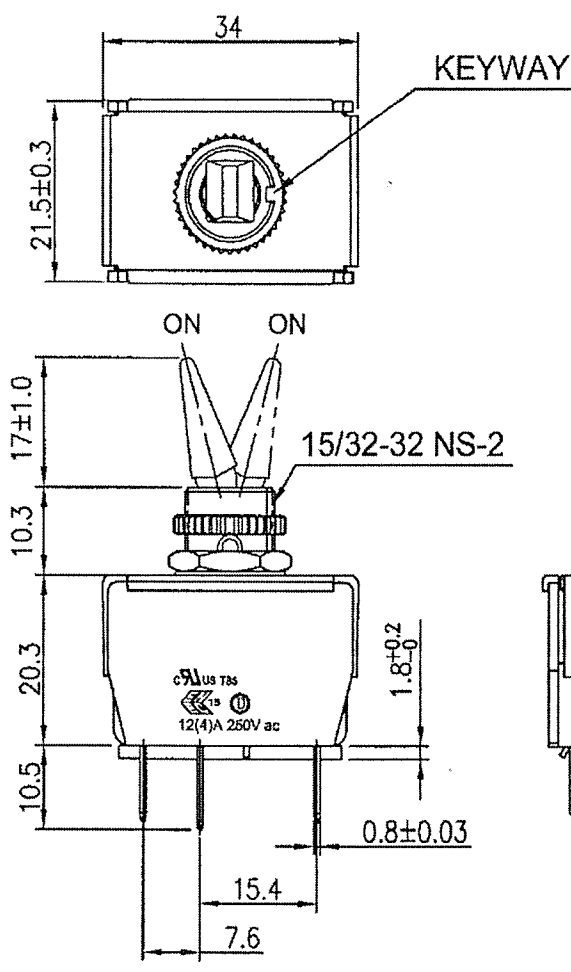

**MATERIAL:**  
 Frame: Nylon 6/6, Black  
 UL Flame: 94-V0  
 Lever: Nylon 66+30%GF  
 UL Flame: 94-V0  
 Terminal: Copper Alloy

Water proof and Dust Proof  
 to fit IP-56

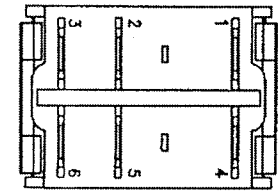

Tolerances Unless Otherwise Specified +/-0.5.

RoHS Compliant		1 Updated views & dimensions. 3-06-13.	
 <b>INDUSTRIES</b> Southampton, Pa. 18966 Tel 215.355.7080/www.cwind.com	Date Drawn: 8/09/2012	Rev. 1	Unit: mm
	Title: <b>TOGGLE SWITCH</b>		Checked By: <i>G. Guld</i>