

SMD Auto COG HV, Ceramic, 180 pF, 5%, 2000 VDC, COG, SMD, MLCC, Ultra-Stable, Low Loss, Automotive Grade, 1206

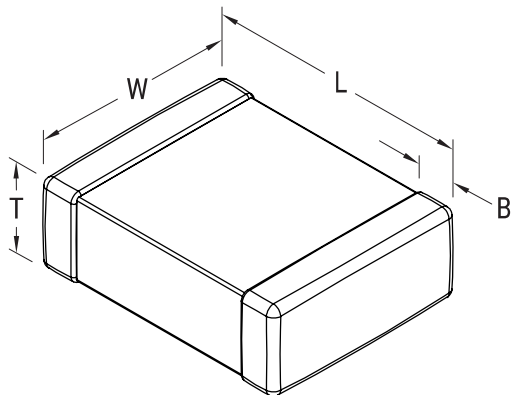

Dimensions

L	3.2mm +/-0.2mm
W	1.6mm +/-0.2mm
T	1.6mm +/-0.15mm
B	0.5mm +/-0.25mm

Packaging Specifications

Packaging:	T&R, 180mm, Plastic Tape
Packaging Quantity:	2000

General Information

Supplier:	KEMET
Series:	SMD Auto COG HV
Style:	SMD Chip
Description:	SMD, MLCC, Ultra-Stable, Low Loss, Automotive Grade
Features:	Ultra-Stable, Low Loss, Automotive Grade
RoHS:	Yes
Termination:	Tin
Marking:	No
Qualifications:	AEC-Q200
AEC-Q200:	Yes
Chip Size:	1206

Specifications

Capacitance:	180 pF
Capacitance Tolerance:	5%
Voltage DC:	2000 VDC
Dielectric Withstanding Voltage:	2,400 V
Temperature Range:	-55/+125C
Temperature Coefficient:	COG
Dissipation Factor:	0.10% 1MHz 25C
Aging Rate:	0% Loss/Decade Hour
Insulation Resistance:	100 GOhms