

CGHV96050F2

50 W, 7.9 - 9.6 GHz, 50-ohm, Input/Output Matched GaN HEMT

Cree's CGHV96050F2 is a gallium nitride (GaN) High Electron Mobility Transistor (HEMT) on Silicon Carbide (SiC) substrates. This GaN Internally Matched (IM) FET offers excellent power added efficiency in comparison to other technologies. GaN has superior properties compared to silicon or gallium arsenide, including higher breakdown voltage, higher saturated electron drift velocity and higher thermal conductivity. GaN HEMTs also offer greater power density and wider bandwidths compared to GaAs transistors. This IM FET is available in a metal/ceramic flanged package for optimal electrical and thermal performance.

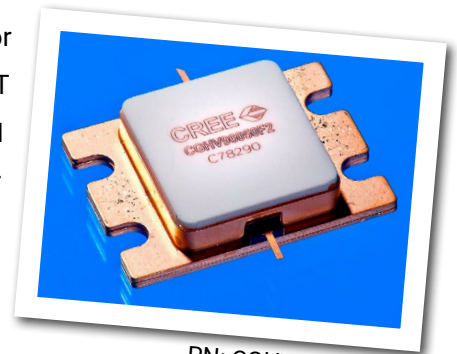

PN: CGHV96050F2
Package Type: 440217

Typical Performance Over 8.4-9.6 GHz ($T_c = 25^\circ\text{C}$)

Parameter	8.4 GHz	8.8 GHz	9.0 GHz	9.2 GHz	9.4 GHz	9.6 GHz	Units
Linear Gain	13.8	12.8	12.3	12.3	12.2	11.8	dB
Output Power	85	77	81	82	75	75	W
Power Gain	10.4	9.9	10.1	10.1	9.8	9.8	dB
Power Added Efficiency	57	54	52	54	48	45	%

Note: Measured in CGHV96050F2-AMP (838179) under 100 uS pulse width, 10% duty, Pin 39.0 dBm (7.9 W)

Features

- 8.4 - 9.6 GHz Operation
- 80 W P_{OUT} typical
- 10 dB Power Gain
- 55 % Typical PAE
- 50 Ohm Internally Matched
- <0.1 dB Power Droop

Applications

- Marine Radar
- Weather Monitoring
- Air Traffic Control
- Maritime Vessel Traffic Control
- Port Security

Large Signal Models Available for ADS and MWO

Absolute Maximum Ratings (not simultaneous)

Parameter	Symbol	Rating	Units	Conditions
Drain-source Voltage	V_{DSS}	100	Volts	25°C
Gate-source Voltage	V_{GS}	-10, +2	Volts	25°C
Power Dissipation	P_{DISS}	57.6 / 86.4	Watts	(CW / Pulse)
Storage Temperature	T_{STG}	-65, +150	°C	
Operating Junction Temperature	T_J	225	°C	
Maximum Drain Current	I_{DMAX}	6	Amps	
Maximum Forward Gate Current	I_{GMAX}	14.4	mA	25°C
Soldering Temperature ¹	T_S	245	°C	
Screw Torque	τ	40	in-oz	
Thermal Resistance, Junction to Case	$R_{\theta JC}$	1.40	°C/W	Pulse Width = 100 μ s, Duty Cycle = 10%, $P_{DISS} = 86.4$ W
Thermal Resistance, Junction to Case	$R_{\theta JC}$	2.12	°C/W	CW, 85°C, $P_{DISS} = 57.6$ W
Case Operating Temperature ³	T_C	-40, +125	°C	

Note:

¹ Current limit for long term reliable operation.

² Refer to the Application Note on soldering at <http://www.cree.com/rf/document-library>

³ See also, the Power Dissipation De-rating Curve on Page 9.

Electrical Characteristics (Frequency = 9.6 GHz unless otherwise stated; $T_C = 25^\circ\text{C}$)

Characteristics	Symbol	Min.	Typ.	Max.	Units	Conditions
DC Characteristics¹						
Gate Threshold Voltage	$V_{GS(TH)}$	-3.8	-3.0	-2.3	V	$V_{DS} = 10$ V, $I_D = 14.4$ mA
Gate Quiescent Voltage	V_Q	-	-3.0	-	V	$V_{DS} = 40$ V, $I_D = 500$ mA
Saturated Drain Current ²	I_{DS}	10.5	13.0	-	A	$V_{DS} = 6.0$ V, $V_{GS} = 2.0$ V
Drain-Source Breakdown Voltage	V_{BD}	100	-	-	V	$V_{GS} = -8$ V, $I_D = 14.4$ mA
RF Characteristics³						
Small Signal Gain	S21	10.5	11.8	-	dB	$V_{DD} = 40$ V, $I_{DQ} = 500$ mA, $P_{IN} = -20$ dBm
Input Return Loss 1	S11	-	-5.2	-2.1	dB	$V_{DD} = 40$ V, $I_{DQ} = 500$ mA, $P_{IN} = -20$ dBm, Frequency = 8.4-9.6 GHz
Output Return Loss	S22	-	-12.3	-9.0	dB	$V_{DD} = 40$ V, $I_{DQ} = 500$ mA, $P_{IN} = -20$ dBm
Power Output ^{3,4}	P_{OUT}	47	70	-	W	$V_{DD} = 40$ V, $I_{DQ} = 500$ mA, $P_{IN} = 39$ dBm
Power Added Efficiency ^{3,4}	PAE	32	45	-	%	$V_{DD} = 40$ V, $I_{DQ} = 500$ mA, $P_{IN} = 39$ dBm
Output Mismatch Stress	VSWR	-	-	5:1	Ψ	No damage at all phase angles, $V_{DD} = 40$ V, $I_{DQ} = 500$ mA,

Notes:

¹ Measured on-wafer prior to packaging.

² Scaled from PCM data.

³ Measured in CGHV96050F2-AMP (AD-09115) under 100 μ s pulse width, 10% duty

⁴ Fixture loss de-embedded using the following offsets. At 9.6 GHz, input and output = 0.50 dB.

CGHV96050F2 Typical Performance

Figure 1. - Small Signal Gain and Return Loss vs Frequency of CGHV96050F2 measured in CGHV96050F2-AMP

$V_{DS} = 40\text{ V}, I_{DQ} = 500\text{ mA}$

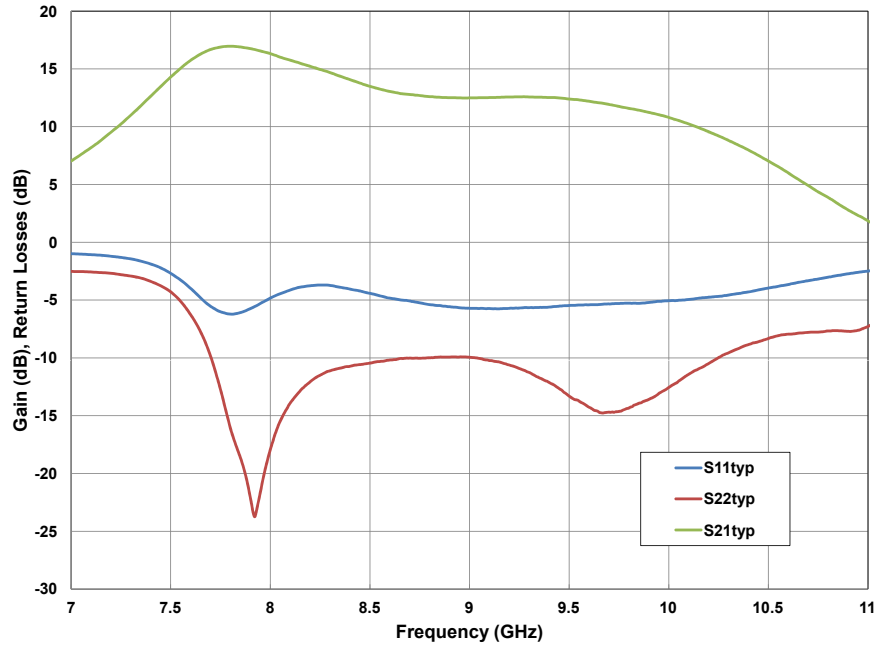
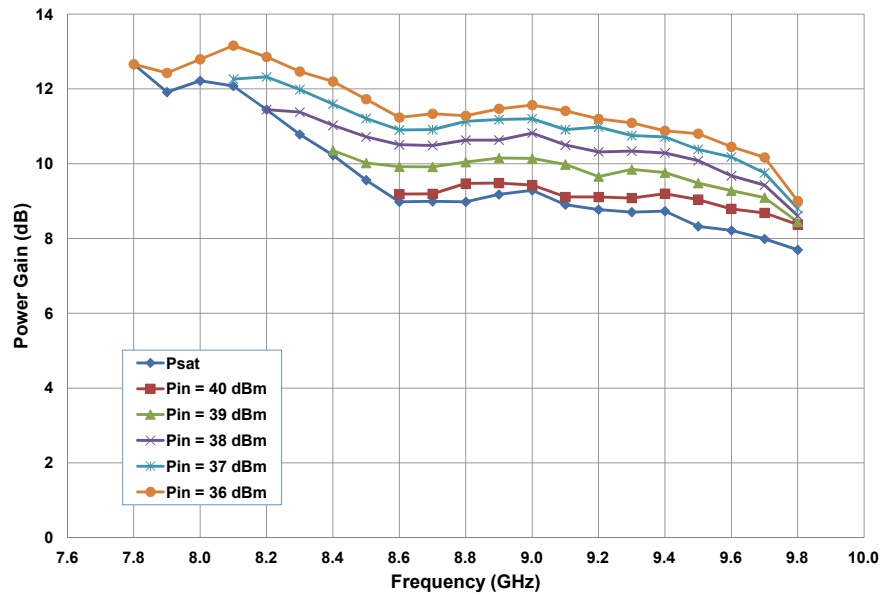

Figure 2. - Power Gain vs. Frequency and Input Power

$V_{DD} = 40\text{ V}, \text{Pulse Width} = 100\ \mu\text{sec}, \text{Duty Cycle} = 10\%$



CGHV96050F2 Typical Performance

Figure 3. - Output Power vs. Input Power
 $V_{nn} = 40\text{ V}$, Pulse Width = 100 μsec , Duty Cycle = 10%

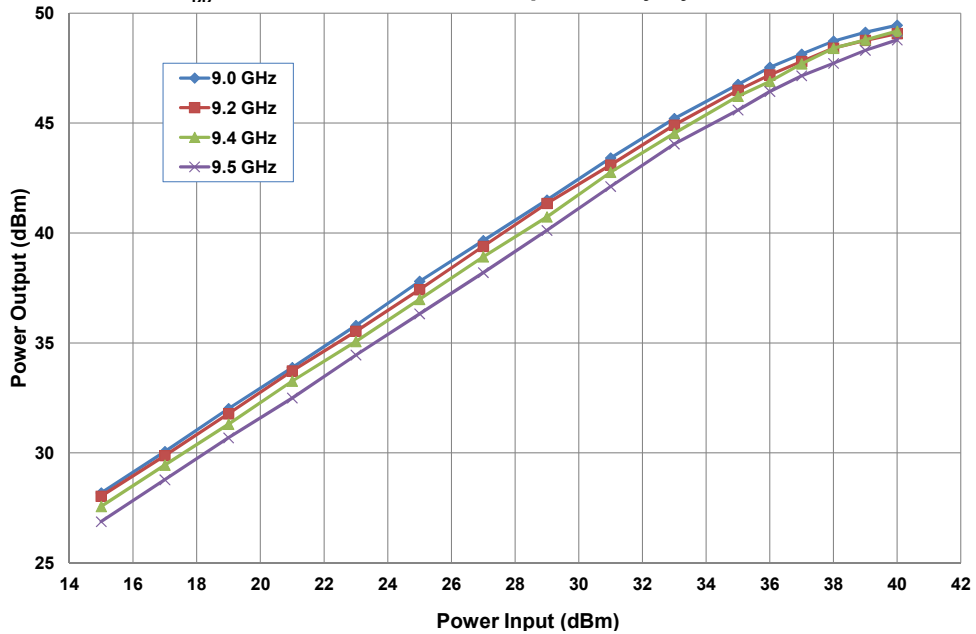
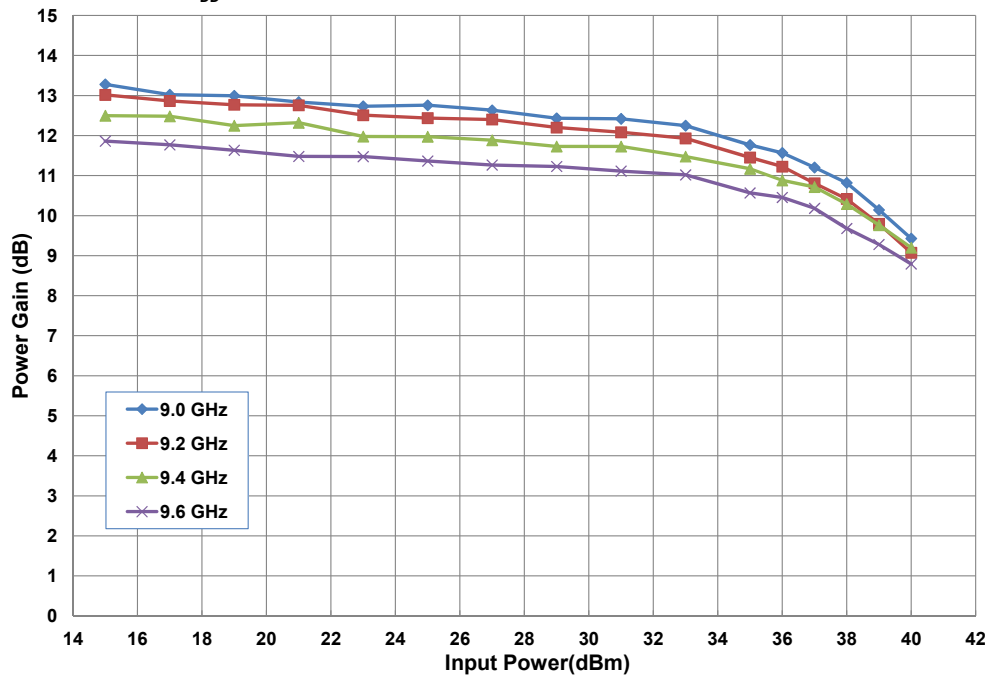

Figure 4. - Power Gain vs. Frequency and Input Power
 $V_{DD} = 40\text{ V}$, Pulse Width = 100 μsec , Duty Cycle = 10%



CGHV96050F2 Typical Performance

Figure 5. - Power Added Efficiency vs. Input Power
 $V_{DD} = 40\text{ V}$, Pulse Width = 100 μsec , Duty Cycle = 10%

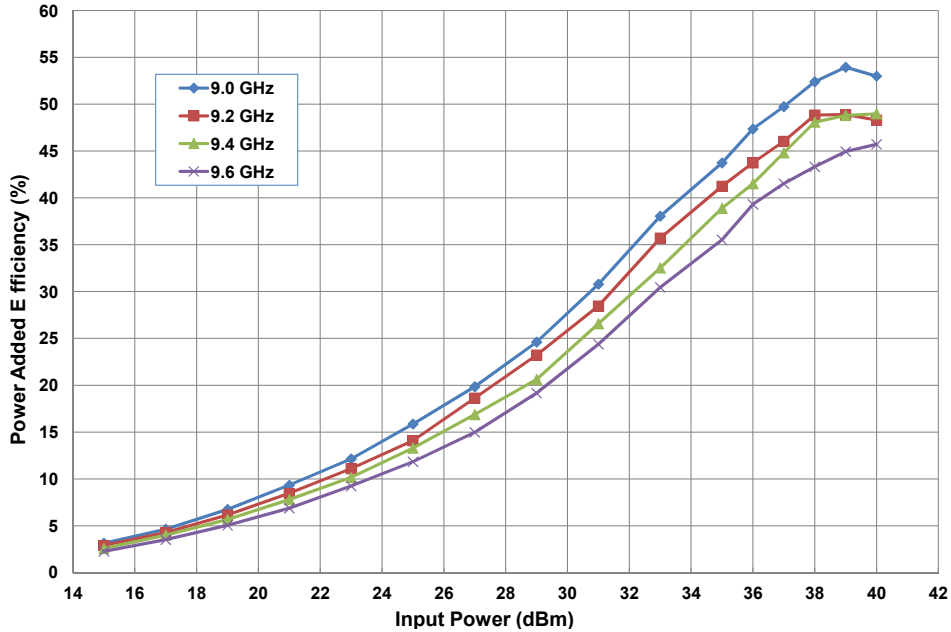
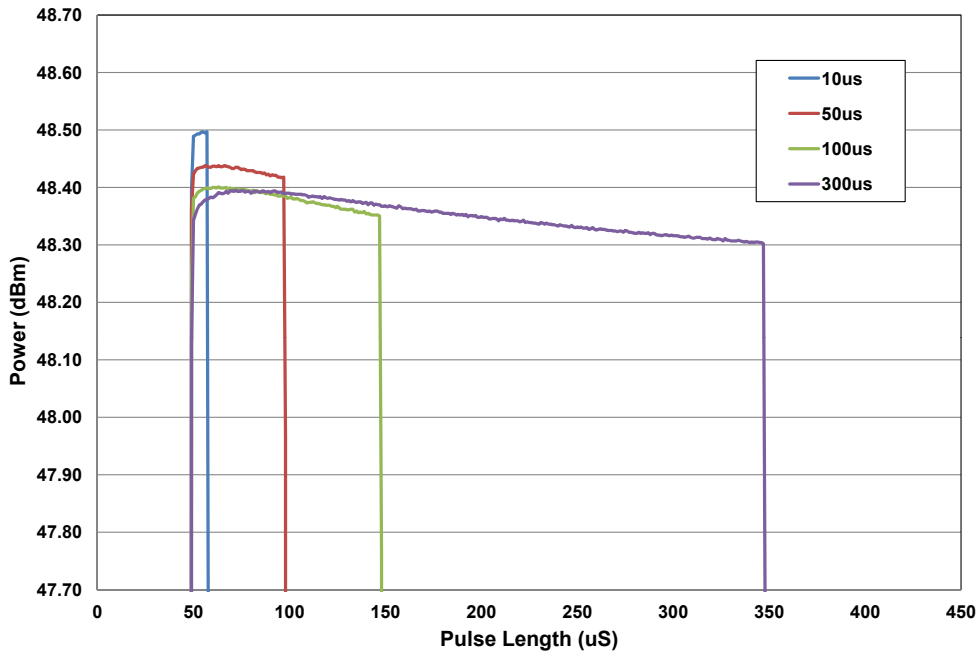

Figure 6. - Output Power vs. Time
 $V_{DD} = 40\text{ V}$, $P_{IN} = 39\text{ dBm}$, Duty Cycle = 10%



CGHV96050F2 Typical Performance

Figure 7. - Output Power vs. Input Power & Frequency
 $V_{DD} = 40\text{ V}$, Pulse Width = 100 μsec , Duty Cycle = 10%

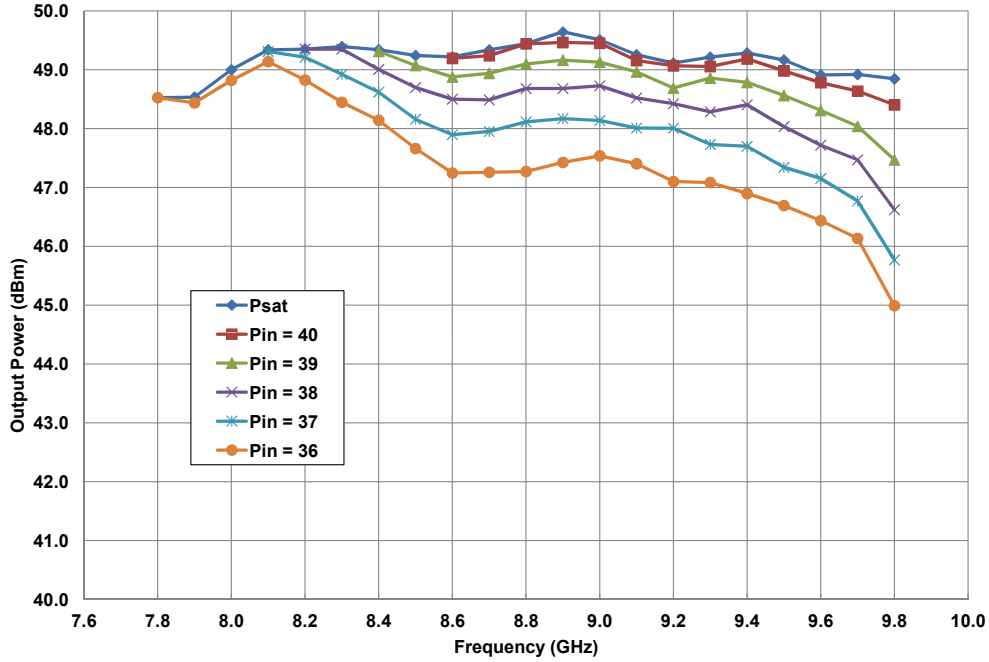
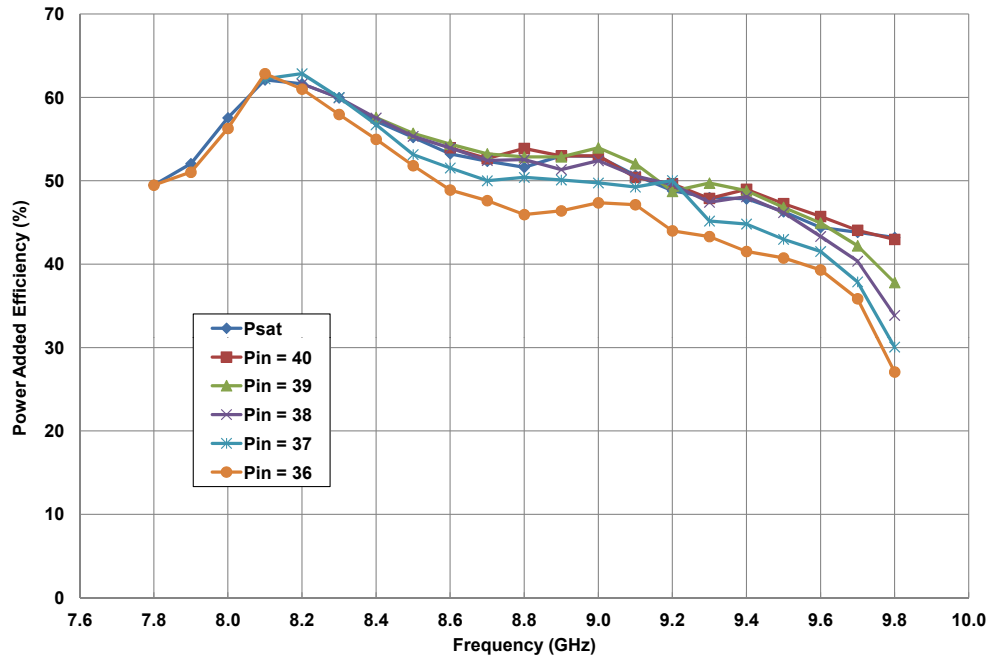

Figure 8. - Power Added Efficiency vs. Input Power & Frequency
 $V_{DD} = 40\text{ V}$, $P_{IN} = 39\text{ dBm}$, Duty Cycle = 10%



CGHV96050F2-AMP Demonstration Amplifier Circuit Bill of Materials

Designator	Description	Qty
R1	RES, 47 OHM, +/- 1%, 1/16W,0603	1
C1	CAP, 0.9pF, +/- 0.05pF,200V, 0402	1
C11	CAP, 1.6pF, +/- 0.1 pF,200V, 0402	1
C2, C12	CAP, 1.0pF, +/- 0.1 pF,200V, 0402	2
C3,C13	CAP, 10.0pF, +/-5%,250V, 0603,	2
C4,C14	CAP, 470PF, 5%, 100V, 0603, X	2
C5,C15	CAP,33000PF, 0805,100V, X7R	2
C6	CAP 10UF 16V TANTALUM	1
C18	CAP, 470uF, 20%, 80V, ELECT, SMD Size K	1
J1,J2	CONN,N,FEM,W/.500 SMA FLNG	2
J3	HEADER RT>PLZ .1CEN LK 9POS	1
J4	CONNECTOR ; SMB, Straight, JACK,SMD	1
W1	CABLE ,18 AWG, 4.2"	1
	PCB, RF35, 2.5 X 3.0 X (0.020/0.250)	1
	TRANSISTOR, CGHV96050F2	1
	#2 SPLIT LOCKWASHER SS	4
	2-56 SOC HD SCREW 1/4 SS	4

CGHV96050F2-AMP Demonstration Amplifier Circuit



CGHV96050F2-AMP Demonstration Amplifier Circuit Schematic

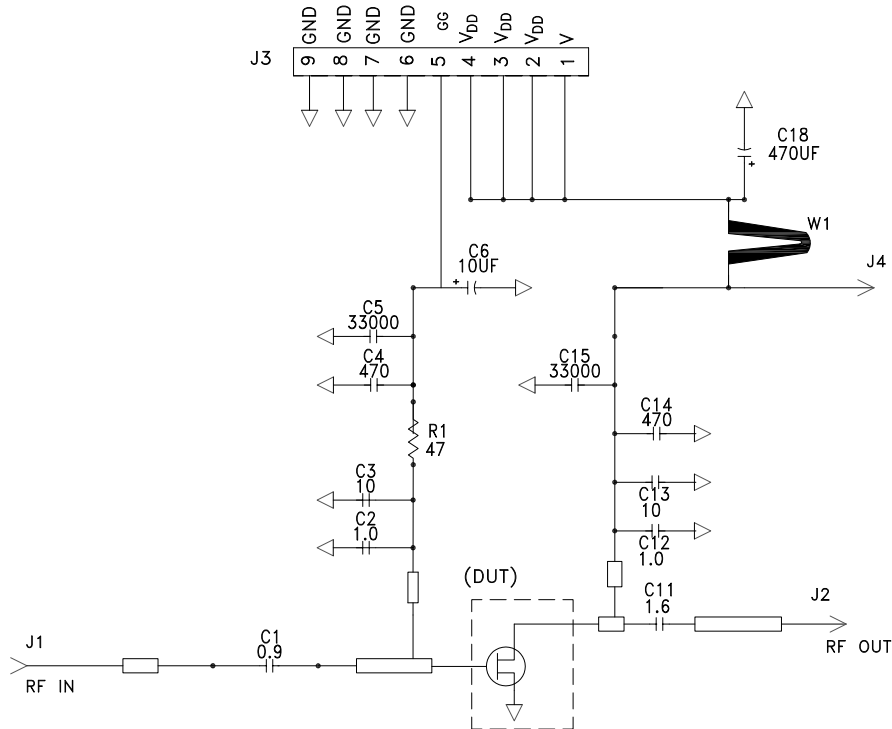

CGHV96050F2-AMP Demonstration Amplifier Circuit Outline

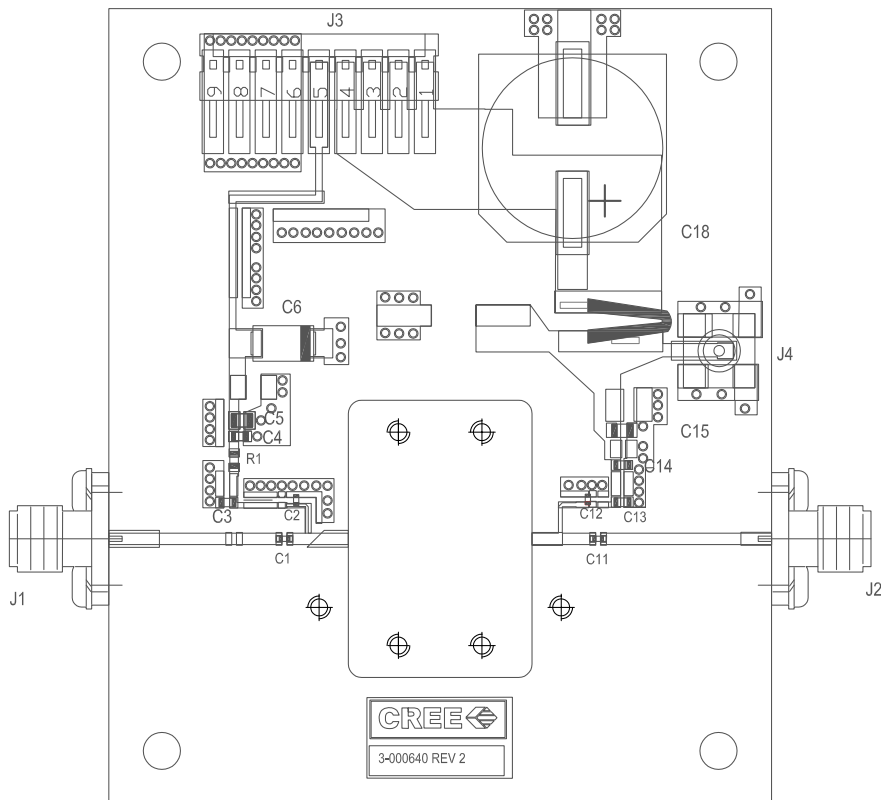

CGHV96050F2 Power Dissipation De-rating Curve

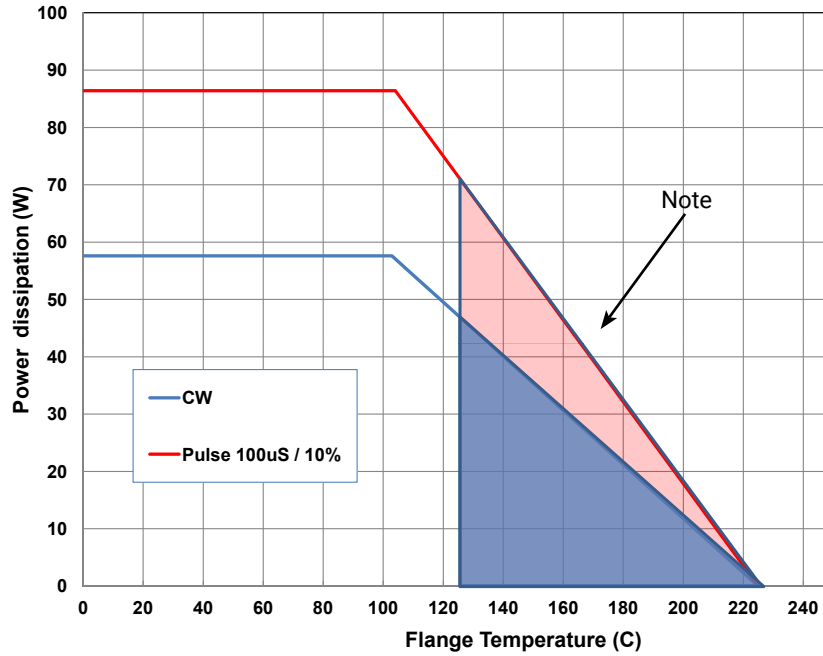

Note: Shaded area exceeds Maximum Case Operating Temperature (See Page 2).

Electrostatic Discharge (ESD) Classifications

Parameter	Symbol	Class	Test Methodology
Human Body Model	HBM	1A (> 250 V)	JEDEC JESD22 A114-D
Charge Device Model	CDM	II (200 < 500 V)	JEDEC JESD22 C101-C

Product Dimensions CGHV96050F2 (Package Type – 440217)

NOTES: (UNLESS OTHERWISE SPECIFIED)

1. INTERPRET DRAWING IN ACCORDANCE WITH ANSI Y14.5M-2009
2. ADHESIVE FROM LID MAY EXTEND A MAXIMUM OF .020 BEYOND EDGE OF LID
3. LID MAY BE MISALIGNED TO THE BODY OF PACKAGE BY A MAXIMUM OF .008 IN ANY DIRECTION
4. ALL PLATED SURFACES ARE GOLD OVER NICKEL

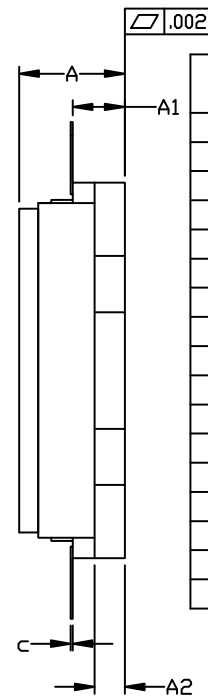
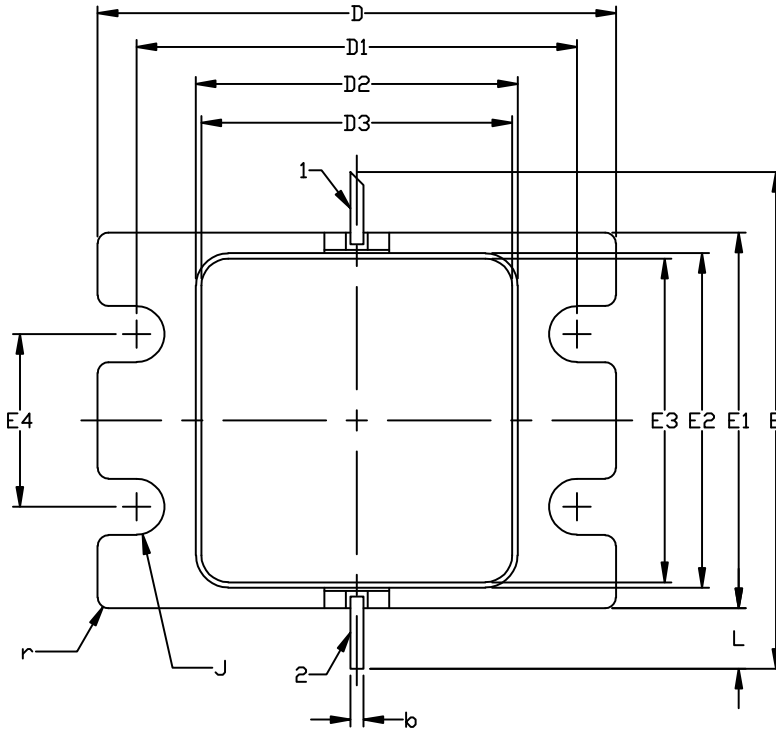

1. GATE
2. DRAIN

DIM	INCHES		MILLIMETERS		NOTES
	MIN	MAX	MIN	MAX	
A	0.188	0.198	4.78	5.03	
A1	0.088	0.100	2.24	2.54	2x
A2	0.049	0.061	1.24	1.55	
b	0.022	0.026	0.56	0.66	2x
c	0.002	0.006	0.05	0.15	
D	0.935	0.955	23.75	24.26	
D1	0.797	0.809	20.24	20.55	2x
D2	0.581	0.593	14.76	15.06	
D3	0.563	0.571	14.30	14.50	
E	0.906		23.01		REF
E1	0.679	0.691	17.25	17.55	
E2	0.604	0.616	15.34	15.65	
E3	0.586	0.594	14.88	15.09	
E4	0.309	0.321	7.85	8.15	2x
J	∅0.097	∅0.107	∅2.46	∅2.72	4x
L	0.090	0.130	2.29	3.30	2x
r	0.02 TYP		0.51 TYP		12x

CGHV96050F2

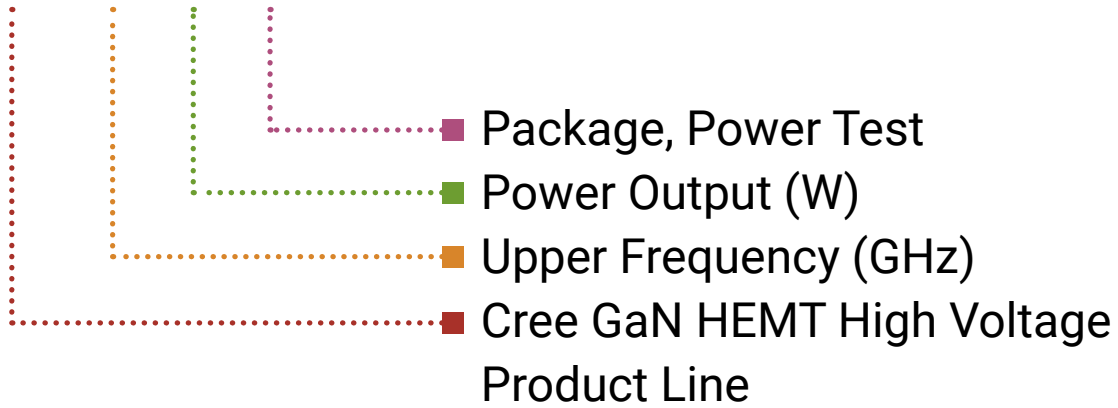

Parameter	Value	Units
Upper Frequency ¹	9.6	GHz
Power Output	50	W
Package	Flange	-

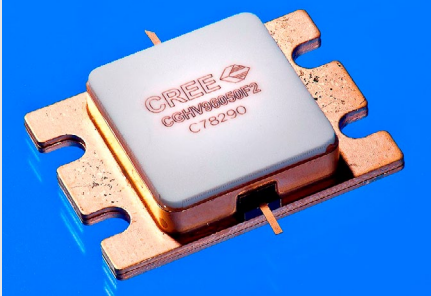

Table 1.

Note¹: Alpha characters used in frequency code indicate a value greater than 9.9 GHz. See Table 2 for value.

Character Code	Code Value
A	0
B	1
C	2
D	3
E	4
F	5
G	6
H	7
J	8
K	9
Examples:	1A = 10.0 GHz 2H = 27.0 GHz

Table 2.

Product Ordering Information

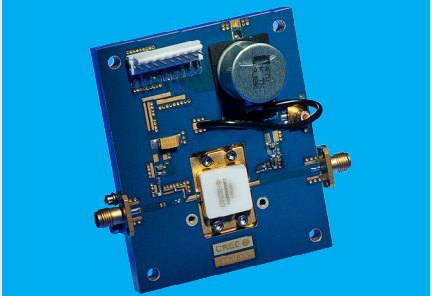
Order Number	Description	Unit of Measure	Image
CGHV96050F2	GaN HEMT	Each	
CGHV96050F2-TB	GaN HEMT	Each	
CGHV96050F2-AMP	Test board without GaN HEMT	Each	
CGHV96050F2-JMT	CGHV96050F2 Delivered in a JEDEC Matrix tray	50 parts / tray. Order multiple = 50pcs	



Disclaimer

Specifications are subject to change without notice. Cree, Inc. believes the information contained within this data sheet to be accurate and reliable. However, no responsibility is assumed by Cree for its use or for any infringement of patents or other rights of third parties which may result from its use. No license is granted by implication or otherwise under any patent or patent rights of Cree. Cree makes no warranty, representation or guarantee regarding the suitability of its products for any particular purpose. "Typical" parameters are the average values expected by Cree in large quantities and are provided for information purposes only. These values can and do vary in different applications, and actual performance can vary over time. All operating parameters should be validated by customer's technical experts for each application. Cree products are not designed, intended, or authorized for use as components in applications intended for surgical implant into the body or to support or sustain life, in applications in which the failure of the Cree product could result in personal injury or death, or in applications for the planning, construction, maintenance or direct operation of a nuclear facility. CREE and the CREE logo are registered trademarks of Cree, Inc.

For more information, please contact:

Cree, Inc.
4600 Silicon Drive
Durham, North Carolina, USA 27703
www.cree.com/RF

Sarah Miller
Marketing
Cree, RF Components
1.919.407.5302

Ryan Baker
Marketing & Sales
Cree, RF Components
1.919.407.7816

Tom Dekker
Sales Director
Cree, RF Components
1.919.407.5639