

LOC		DIST		REVISIONS			
HM	00	REV	DESCRIPTION	DATE	DMN	APVD	
A		REV ECO-05-013206		23NOV05	LH	GB	
B		REV ECO-09-024123		02NDV09	LH	RA	
C		REV ECO-10-011451		01JUN2010	LH	RA	

ICON WHEEL,  
VOICE, DATA,  
CATEGORY  
QUANTITY 1

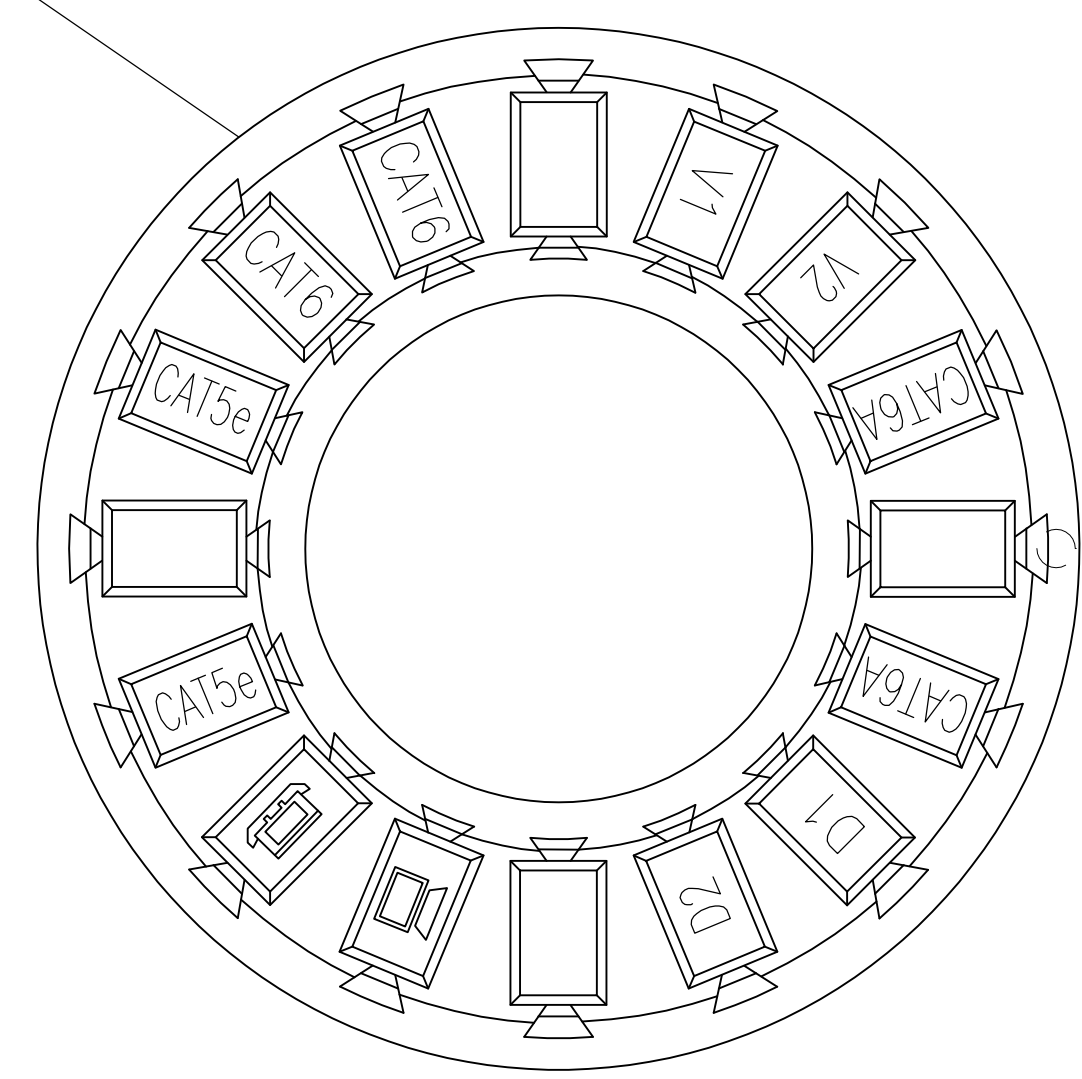

FACEPLATE ASSEMBLY

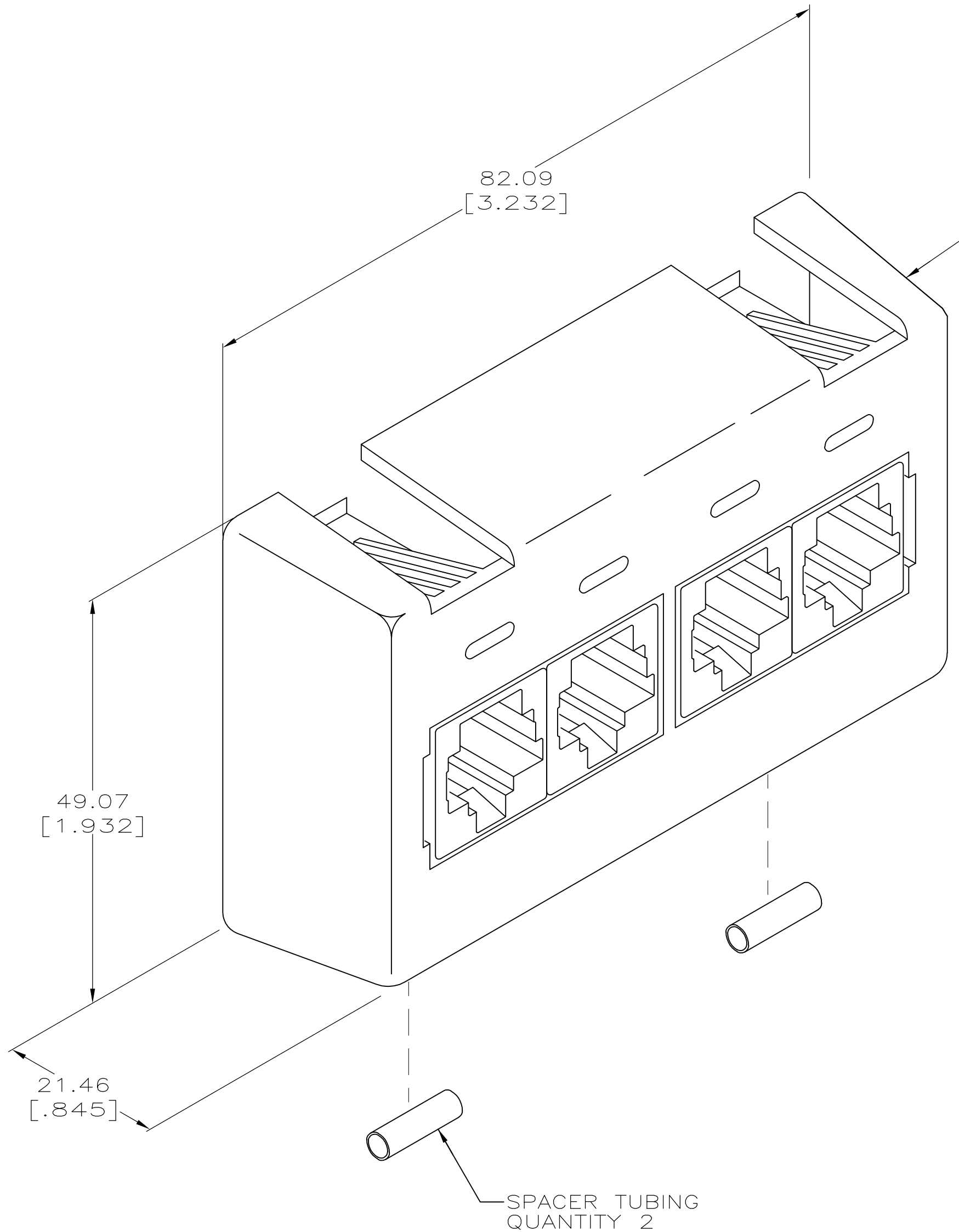

SPACER TUBING  
QUANTITY 2

UNIVERSAL WIRING  
LABEL

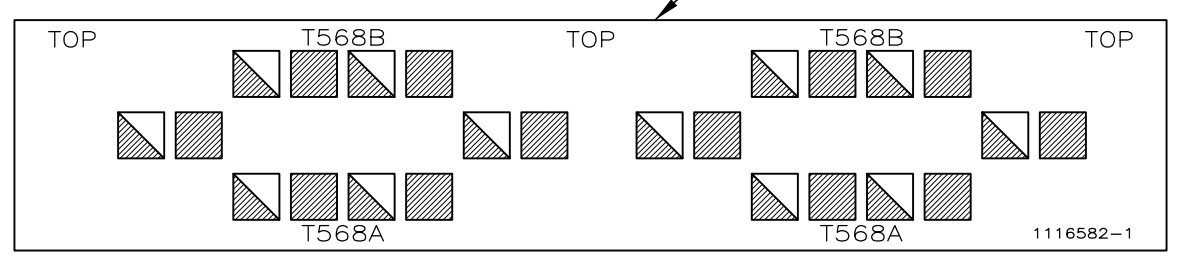

**T568A**  
 WHITE/GREEN  
 GREEN/WHITE  
 WHITE/ORANGE  
 BLUE/WHITE  
 WHITE/BLUE  
 ORANGE/WHITE  
 WHITE/BROWN  
 BROWN/WHITE

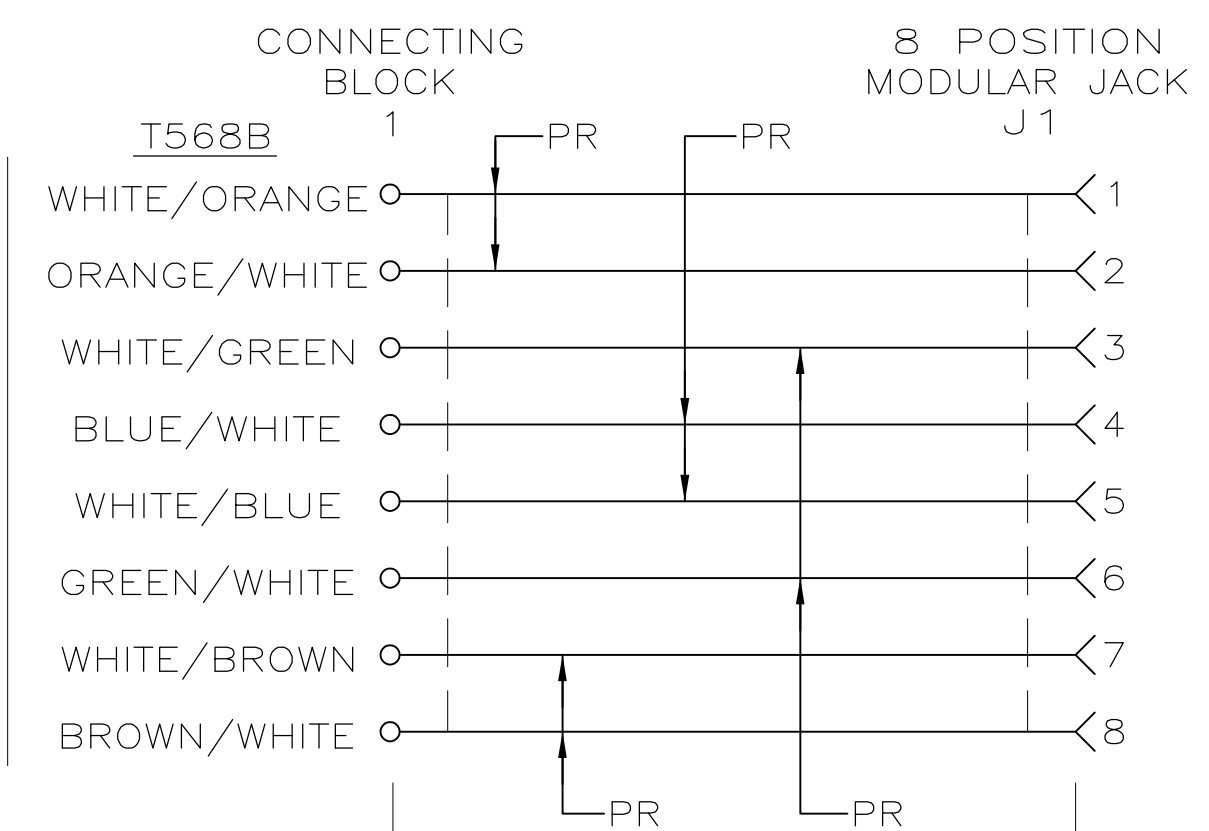

**T568A**  
 WHITE/GREEN  
 GREEN/WHITE  
 WHITE/ORANGE  
 BLUE/WHITE  
 WHITE/BLUE  
 ORANGE/WHITE  
 WHITE/BROWN  
 BROWN/WHITE

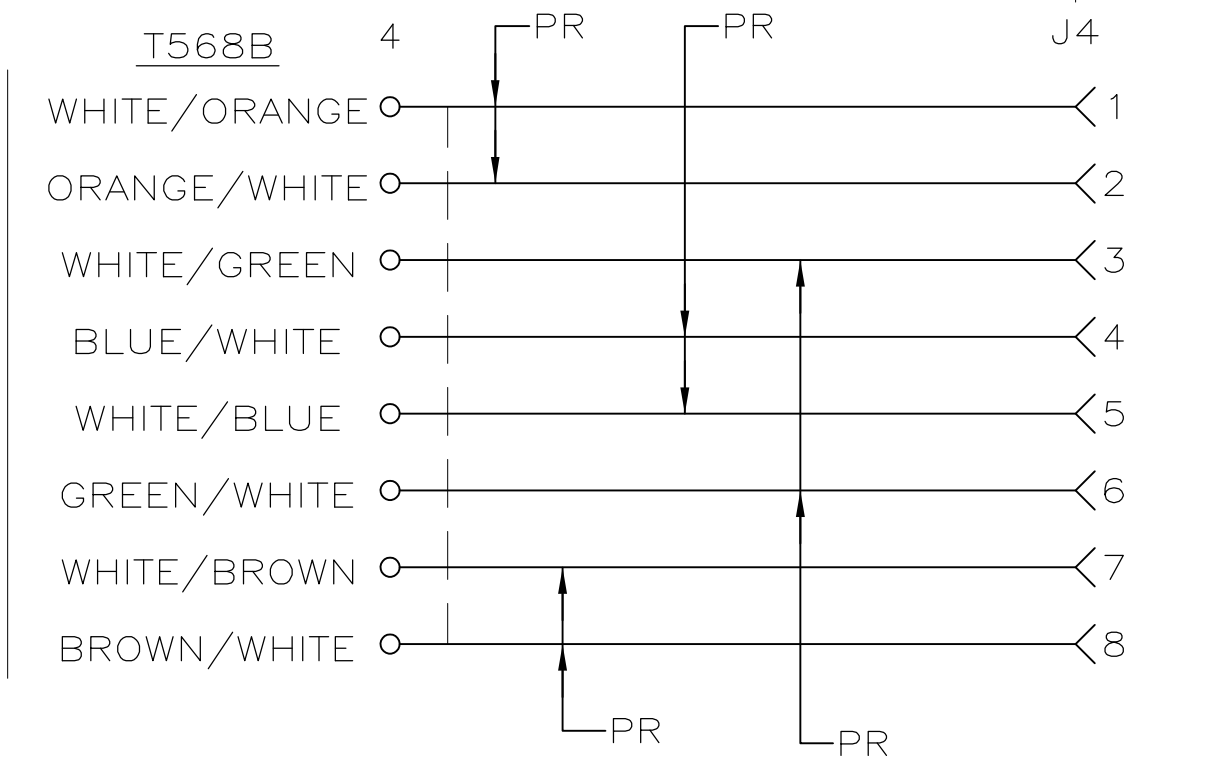

ELECTRICAL SCHEMATIC  
FOR T568A OR T568B  
WIRING PATTERN

11.18  
[.44]

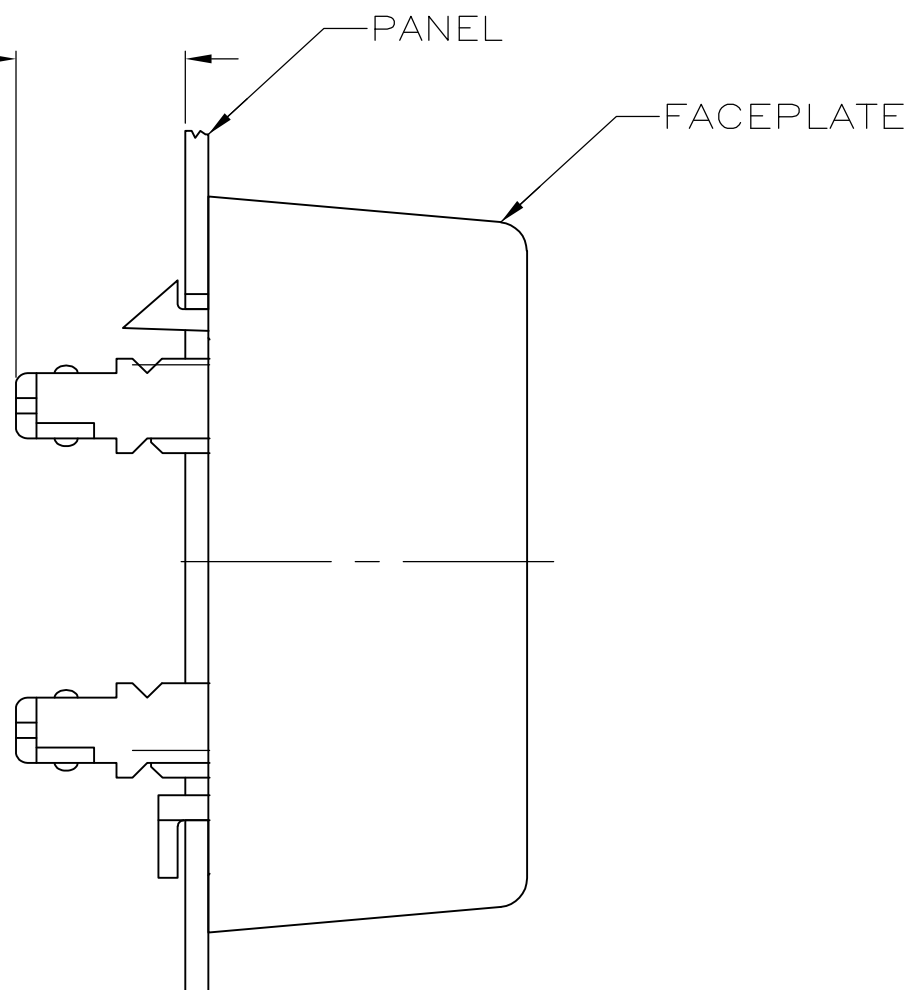

SUGGESTED MOUNTING

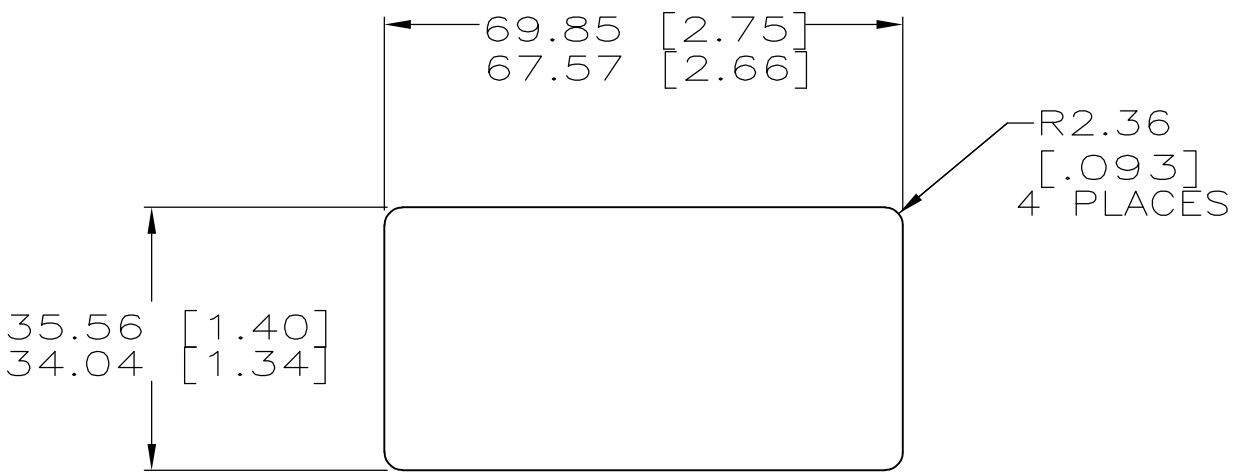

RECOMMENDED PANEL CUTOUT

NEMA GRAY	1116580-4
LIGHT ALMOND	1116580-2
BLACK	1116580-1
COLOR	PART NO.

THIS DRAWING IS A CONTROLLED DOCUMENT.

DIMENSIONS: mm [INCHES]	TOLERANCES UNLESS OTHERWISE SPECIFIED:	0 PLC ± -	1 PLC ± -	2 PLC ± -	3 PLC ± -	4 PLC ± -	ANGLES ± -
----------------------------	----------------------------------------	-----------	-----------	-----------	-----------	-----------	------------

DIN G. GARRETT 13AUG99	APVD G. ROWMAN 13AUG99	NAME	RESTRICTED TO
CHK G. ROWMAN	APVD G. ROWMAN 13AUG99	FACEPLATE KIT, RJ45, 110 CONNECT, CAT 5e, FLEXMODE	
PRODUCT SPEC	APPLICATION SPEC	SIZE	SCALE
	408-4549	A1	2:1
MATERIAL	WEIGHT	SIZE	SCALE
		400779	2:1
		1116580	2:1
		1116580	2:1

CUSTOMER DRAWING