

Evaluation Board for the AD7124-8— 8-Channel, Low Noise, Low Power, 24-bit S-D ADC with In- Amp and Reference

FEATURES

- Full featured evaluation board for the AD7124-8
- PC control in conjunction with the system demonstration platform ([EVAL-SDP-CB1Z](#))
- PC software for control and data analysis (time domain)
- Standalone capability

ONLINE RESOURCES

- Evaluation Kit Contents
 - EVAL-AD7124-8SDZ evaluation board
 - Evaluation software CD for the AD7124-8
- Documents Needed
 - AD7124-8 data sheet
 - AD7124-8 user guide
- Required Software
 - EVAL-AD7124-8SDZ evaluation software

A 7 V to 9 V external supply is regulated to 3.3 V to supply the AD7124-8 and support all necessary components. The EVAL-AD7124-8SDZ board connects to the USB port of the PC by connection to the [EVAL-SDP-CB1Z](#) motherboard.

The EVAL-AD7124-8SDZ software fully configures the AD7124-8 device register functionality and provides dc time domain analysis in the form of waveform graphs, histograms, and associated noise analysis for ADC performance evaluation.

The EVAL-AD7124-8SDZ is an evaluation board that is designed to allow the user to evaluate the features of the ADC. The user PC software executable controls the AD7124-8 over the USB through the system demonstration platform board ([EVAL-SDP-CB1Z](#)).

EQUIPMENT NEEDED

- EVAL-AD7124-8SDZ evaluation board
- [EVAL-SDP-CB1Z](#) system demonstration platform
- DC signal source
- USB cable
- PC running Windows with USB 2.0 port

GENERAL DESCRIPTION

The EVAL-AD7124-8SDZ evaluation kit features the AD7124-8 24-bit, low power, low noise analog-to-digital converter (ADC).

FUNCTIONAL BLOCK DIAGRAM

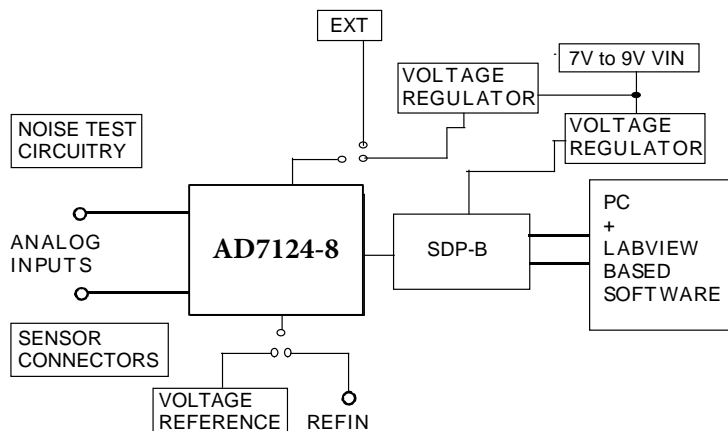

Figure 1. EVAL-AD7124-8SDZ Block Diagram

TABLE OF CONTENTS

Features	1	Serial Interface	6
Online Resources	1	Analog Inputs.....	6
Equipment Needed.....	1	Reference Options	7
General Description	1	Evaluation Board Setup Procedures	7
Functional Block Diagram	1	Evaluation Board Software.....	8
Revision History	2	Software Installation Procedures.....	8
EVAL-AD7124-8SDZ Quick Start Guide.....	3	Setting Up the System for Data Capture	11
Evaluation Board Hardware	4	Software Operation	12
Device Description.....	4	Evaluation Board Schematics and Artwork.....	18
Hardware Link Options.....	4	EVAL-AD7124-8SDZ Bill of Materials.....	27
Power Supplies	6		

REVISION HISTORY

1/15—Revision PrA: Initial Version

EVAL-AD7124-8SDZ QUICK START GUIDE

To begin using the evaluation board, do the following:

1. With the EVAL-SDP-CB1Z board disconnected from the USB port of the PC, install the AD7124-8 evaluation board software from the CD included in the evaluation board kit. The PC must be restarted after the software installation is complete. (For complete software installation instructions, see the Software Installation Procedures section.)
2. Connect the [EVAL-SDP-CB1Z](#) board to the EVAL-AD7124-8SDZ board.
 - a. Screw the two boards together using the plastic screw-washer set included in the evaluation board kit to ensure that the boards are connected firmly together.
3. Apply an external voltage in the range of 7 V to 9 V to the J3 or J5 connector of the EVAL-AD7124-8SDZ board. This provides the power supply for the board.
4. Connect the [EVAL-SDP-CB1Z](#) board to the PC using the supplied USB cable. If you are using Windows® XP, you may need to search for the [EVAL-SDP-CB1Z](#) drivers. Choose to automatically search for the drivers for the [EVAL-SDP-CB1Z](#) board if prompted by the operating system.
5. Launch the EVAL-AD7124-8SDZ software from the **Analog Devices** subfolder in the **Programs** menu.

EVALUATION BOARD HARDWARE

DEVICE DESCRIPTION

The AD7124-8 is a low power, low noise, complete analog front end for high precision measurement applications. It contains a low noise, 24-bit Σ - Δ ADC. It can be configured to have four differential inputs or seven single-ended or pseudo-differential inputs. The on-chip low noise instrumentation amplifier means that signals of small amplitude can be interfaced directly to the ADC. Other on-chip features include a low drift 2.5 V reference, excitation currents, reference buffers, multiple filter options and many diagnostic features.

Complete specifications for the AD7124-8 are provided in the product data sheet and should be consulted in conjunction with

this user guide when using the evaluation board. Full details about the EVAL-SDP-CB1Z are available on the Analog Devices, Inc., website.

HARDWARE LINK OPTIONS

The default link options are listed in Table 1. By default, the board is configured to operate from a wall wart (dc plug) power supply via Connector J5. The supply required for the AD7124-8 comes from the on-board [ADP1720](#) LDOs, which generate their input voltage from J5.

Table 1. Default Link and Solder Link Options

Link No.	Default Option	Description
LK1	A	Connects the AVDD voltage to the power supply sequencer, ADM1185 . When AVDD equals 3.3 V, LK1 must be in Position A. When AVDD equals 1.8 V, LK1 must be in Position B.
LK2	B	Selects the connector for the external 7 V to 9 V power supply. In Position A, this link selects the external 7 V to 9 V power supply to come from Connector J3. In Position B, this link selects the external 7 V to 9 V power supply to come from Connector J5.
LK3	Inserted	Inserting this link connects REFIN(-) to AVSS.
LK4	2.5 V	Selects the reference source for the ADC. In position 2.5V, REFIN1(+) is connected to the external 2.5 V reference (ADR4525). In position INT REF, REFIN1(+) is connected to the REFOUT pin of the AD7124-8. The AD7124-8's internal reference can be enabled and applied to the AD7124-8 external to the ADC.
LK5	Inserted	This link shorts AIN0 to AIN1. This is useful to perform noise tests on the AD7124-8. The internal bias can be enabled on AIN0 or AIN1 so that AIN0 and AIN1 are at an appropriate voltage for the noise test.
LK6	Inserted	Headers J13 and J14 can be used to connect channels AIN4 and AIN5 to external components such as an external amplifier. Both links at LK6 should be opened to include the external component on the front-end.
SL2	A	Sets the voltage applied to the AVDD pin. In Position A, this link sets the voltage applied to the AVDD pin to be a 3.3 V supply from the ADP1720-3.3 (U7) regulator or a 2.5 V supply from the ADP1720 (U4) regulator. In Position B, this link sets the voltage applied to the AVDD pin to be supplied from an external voltage source via Connector J9.
SL3, SL7	A, A	With SL3 and SL7 in Position A, AVDD is supplied with 3.3 V from ADP1720-3.3 (U7) regulator. With SL3 and SL7 in Position B, AVDD is supplied with 1.8 V from the ADP1720 (U4) regulator.
SL5	B	With this link in Position A, the IOVDD supply is provided from an external source via Connector J9. With this link in Position B, the 3.3 V supply is generated by the ADP1720-3.3 (U10) regulator. The evaluation system operates with 3.3 V logic.
AVSS to AGND	R49, R50, R51, R52	When these links are inserted, AVSS is tied to AGND. When AVSS is set to -1.8 V, these links must be removed.

On-Board Connectors

Table 2 provides information about the external connectors on the EVAL-AD7124-8SDZ.

Table 2. On-Board Connectors

Connector	Function
J1	A 120-pin connector that mates with the EVAL-SDP-CB1Z (black colored controller board).
J2	Straight PCB Mount SMB/SMA Jack for master clock (not inserted). The EVAL-AD7124-8SDZ has the footprint to include an SMA/SMB connector, if an external clock source is being used to provide the master clock to the ADC.
J3	Bench top power supply voltage input. Apply 7 V to 9 V and GND (0 V) to this connector to power the evaluation board.
J5	Wall wart (dc plug) power supply voltage input. Apply 7 V to 9 V and GND (0 V) to this connector to power the evaluation board.
J6	Analog input connector. Connections to AIN0 to AIN5 are available along with REFIN1(±) connections. This connector can be used to connect an RTD to the AD7124-8.
J9	Optional external connector, allowing external bench top or alternative supply for AVDD and IOVDD. When split supplies are used, AVSS is supplied externally via J9.
J11	Analog input connector. Connections to AIN6 to AIN7 are available along with REFIN1(±) and analog power supply connections. This connector can be used to connect a loadcell to the AD7124-8.
J12	6-pin connector. Provides an I2C interface to allow the SDP to interface to a digital temperature sensor. This is required if a thermocouple is interfaced to the AD7124-8 using connector A2.
J13	7-pin connector which can be used to connect an external amplifier to channel AIN4/AIN5.
J14	7-pin connector which allows connection to pins AIN4 and AIN5.
A0	Straight PCB Mount SMB/SMA Jack. The footprint for an SMA/SMB connector is included on the evaluation board to provide the signal to analog input AIN4.
A1	Straight PCB Mount SMB/SMA Jack. The footprint for an SMA/SMB connector is included on the evaluation board to provide the signal to analog input AIN5.
A2	Thermocouple connector. This connector is required useful if a thermocouple is being interfaced to the evaluation board.
A5	Straight PCB Mount SMB/SMA Jack. The footprint for an SMA/SMB connector is included on the evaluation board to provide the signal REFIN1(+).
A6	Straight PCB Mount SMB/SMA Jack. The footprint for an SMA/SMB connector is included on the evaluation board to provide the signal REFIN1(-).

POWER SUPPLIES

The evaluation board requires that an external power supply—either a bench top supply or a wall wart (dc plug) supply—be applied to J3 or J5 (see Table 3 for more information). Linear regulators generate the required power supply levels from the applied V_{IN} rail. The regulators used are the ADP1720-3.3 (U7) and the ADP1720 (U4), which supply 3.3 V and 1.8 V, respectively, to AVDD of the ADC. The 3.3 V ADP1720 (U10) delivers 3.3 V to the IOVDD pin of the AD7124.4.

When a split power supply is used, the AVSS voltage must be applied from an external source via Connector J9. AVDD and IOVDD can also be provided via Connector J9. However, the 7 V to 9 V supply is still required because the on-board reference (ADR4525) is supplied from this power supply.

Each supply is decoupled at the point where it enters the board and again at the point where it connects to each device (see the schematics shown in **Error! Reference source not found.** to **Error! Reference source not found.** to identify decoupling points).

SERIAL INTERFACE

The AD7124-8 evaluation board connects via the SPI to the Blackfin® ADSP-BF527 on the EVAL-SDP-CB1Z. There are four primary signals: CS, SCLK, DIN, and DOUT/ \overline{RDY} (all are inputs, except for DOUT/ \overline{RDY} , which is an output.)

If you wish to operate the EVAL-AD7124-8SDZ in standalone mode, the AD7124-8 serial interface lines can be disconnected from the 120-pin header by removing the 0 Ω links, R9 through R13. The test points can then be used to fly-wire the signals to an alternative digital capture setup.

ANALOG INPUTS

The EVAL-AD7124-8SDZ primary analog inputs can be applied in two ways:

- Using J6 and J11, the green screw in terminal connectors
- Using the A0 and A1 SMB/SMA footprints on the evaluation board which connect to analog inputs AIN4 and AIN5.

The EVAL-AD7124-8SDZ software is set up to analyze dc inputs to the ADC.

Table 3. Required External Power Supply¹

Power Supply (V_{IN}) Applied To	Voltage Range	Function
J3	7 V to 9 V	Bench top supply to the evaluation board. Supplies LDOs that create 3.3 V and 1.8 V rails. It also supplies the ADR4525 external reference. Ensure that LK2 is set to Position A when the external power supply is applied to this connector.
J5	7 V to 9 V	Wall wart (dc plug) supply to the evaluation board. Supplies LDOs that create 3.3 V and 1.8 V rails. It also supplies the ADR4525 external reference. Ensure that LK2 is set to Position B when the external power supply is applied to this connector.

¹ Only a single supply is required, either J3 or J5. This can be selected using LK2.

REFERENCE OPTIONS

The EVAL-AD7124-8SDZ includes an external 2.5 V reference (the ADR4525) and an internal 2.5 V reference. The default operation is to use the external reference input, which is set to accept the 2.5 V ADR4525 on the evaluation board.

The reference used for a conversion is selected by choosing the reference in the Configx registers associated with Setup 0 to Setup 15.

Switch between using the internal reference and external reference by accessing the AD7124-8 register map via the evaluation software. Figure 2 shows how to select the reference source for Setup 0 to Setup 15. Figure 3 shows the ADC_Control register setting that enables the internal reference.

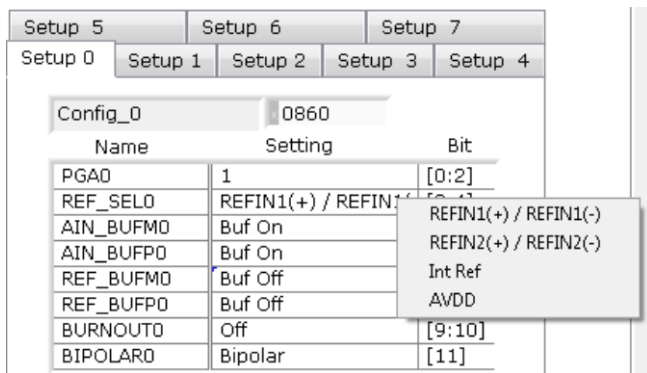

Figure 2. Selecting the Reference Source

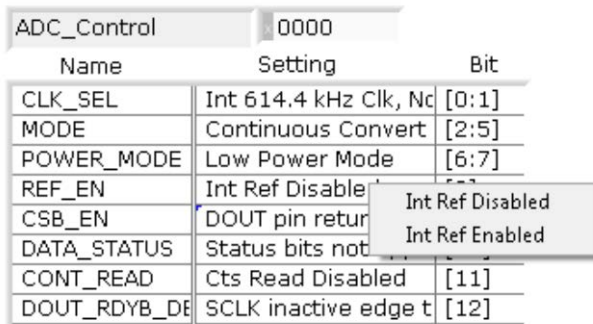

Figure 3. Turning On the Internal 2.5 V Reference

EVALUATION BOARD SETUP PROCEDURES

After following the instructions in the Software Installation Procedures section, set up the evaluation and SDP boards as detailed in this section.

Warning

The evaluation software and drivers must be installed before connecting the evaluation board and EVAL-SDP-CB1Z board to the USB port of the PC to ensure that the evaluation system is correctly recognized when it is connected to the PC.

Configuring the Evaluation and SDP Boards

1. Connect the EVAL-SDP-CB1Z board to Connector A or Connector B on the EVAL-AD7176-2SDZ board. Screw the two boards together using the plastic screw-washer set included in the evaluation board kit to ensure that the boards are connected firmly together.
2. Connect the power supplies to the EVAL-AD7124-8SDZ board. The EVAL-AD7124-8SDZ board, by default, uses the wall wart (dc plug) supply that accompanies the evaluation kit. Connect this supply to J5 on the EVAL-AD7124-8SDZ board. (For more information about the required connections and available options, refer to the Power Supplies section.)
3. Connect the EVAL-SDP-CB1Z board to the PC using the supplied USB cable.

EVALUATION BOARD SOFTWARE

SOFTWARE INSTALLATION PROCEDURES

The EVAL-AD7124-8SDZ evaluation kit includes a CD containing software to be installed on your PC before you begin using the evaluation board.

There are two parts to the installation:

- AD7124-8 evaluation board software installation
- [EVAL-SDP-CB1Z](#) system demonstration platform board drivers installation

Warning

The evaluation software and drivers must be installed before connecting the evaluation board and [EVAL-SDP-CB1Z](#) board to the USB port of the PC to ensure that the evaluation system is correctly recognized when it is connected to the PC.

Installing the AD7124-8 Evaluation Board Software

To install the AD7124-8 evaluation board software,

1. With the [EVAL-SDP-CB1Z](#) board disconnected from the USB port of the PC, insert the installation CD into the CD-ROM drive.
2. Double-click the **setup.exe** file to begin the evaluation board software installation. The software is installed to the following default location: **C:\Program Files\Analog Devices\AD7124-8**.
3. A dialog box appears asking for permission to allow the program to make changes to your computer. Click **Yes**.

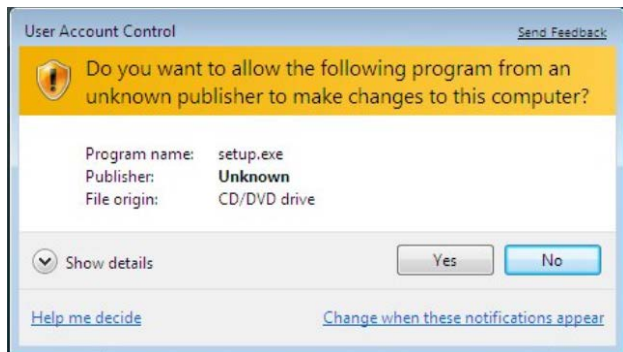

Figure 4. AD7124-8 Evaluation Software Installation: Granting Permission for the Program to Make Changes to Your Computer

4. Select the location to install the software, and then click **Next**. (Figure 5 shows the default locations, which are displayed

when the window opens, but you can select another location by clicking **Browse**.)

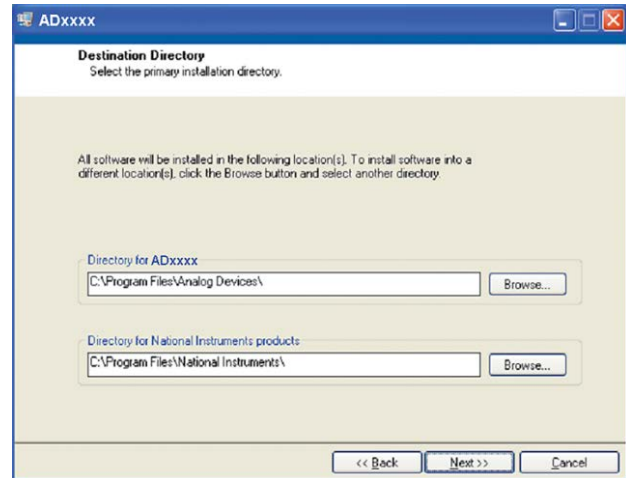

Figure 5. AD7124-8 Evaluation Software Installation: Selecting the Location for Software Installation

5. A license agreement appears. Read the agreement, and then select **I accept the License Agreement** and click **Next**.

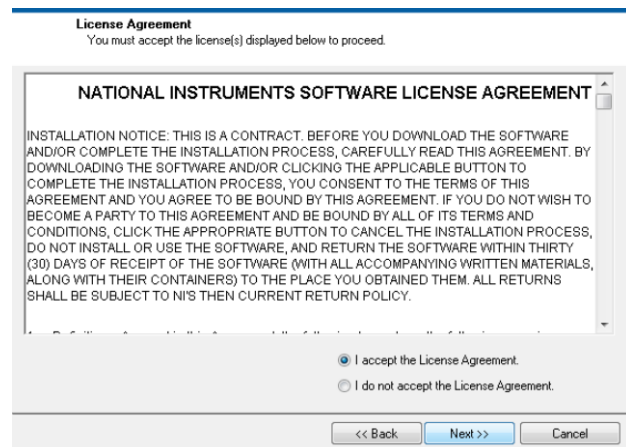

Figure 6. AD7124-8 Evaluation Software Installation: Accepting the License Agreement

6. A summary of the installation is displayed. Click **Next** to continue.

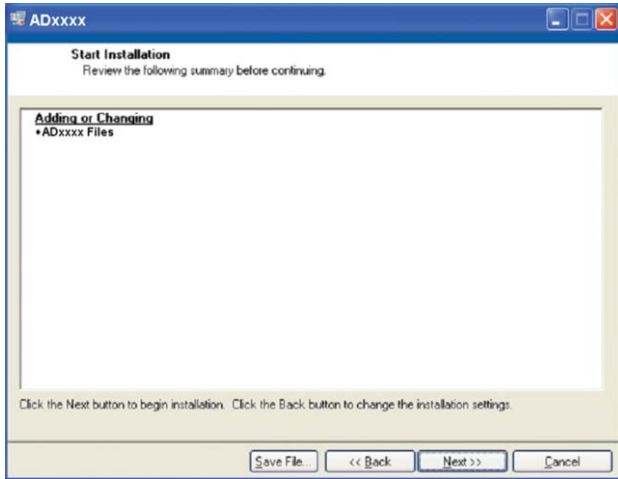

Figure 7. AD7124-8 Evaluation Software Installation: Reviewing a Summary of the Installation

7. A dialog box informs you when the installation is complete. Click **Next**.

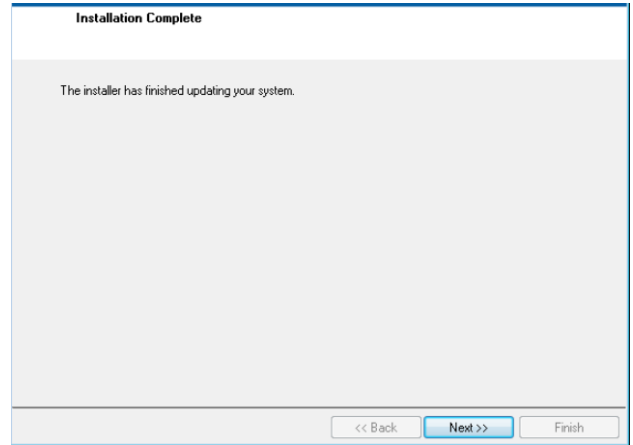

Figure 8. AD7124-8 Evaluation Software Installation: Indicating When the Installation Is Complete

Installing the EVAL-SDP-CB1Z System Demonstration Platform Board Drivers

After the installation of the evaluation software is complete, a welcome window is displayed for the installation of the EVAL-SDP-CB1Z system demonstration platform board drivers.

1. With the EVAL-SDP-CB1Z board still disconnected from the USB port of the PC, make sure that all other applications are closed, and then click **Next**.



Figure 9. EVAL-SDP-CB1Z Drivers Setup: Beginning the Drivers Installation

2. Select the location to install the drivers, and then click **Next**.

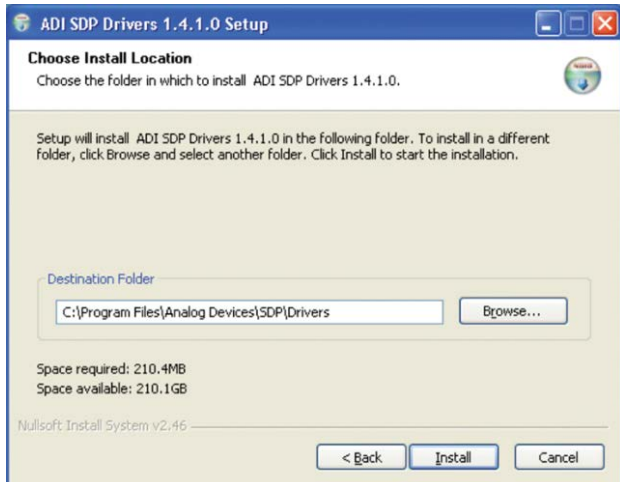

Figure 10. EVAL-SDP-CB1Z Drivers Setup: Selecting the Location for Drivers Installation

3. Click **Install** to confirm that you would like to install the drivers.

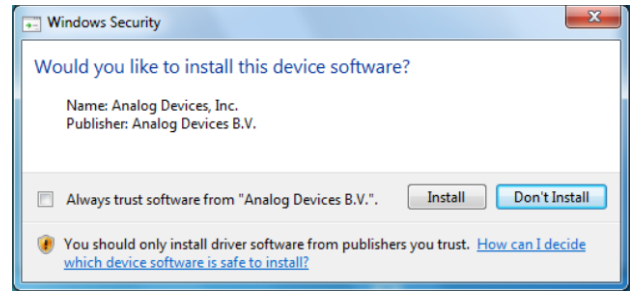

Figure 11. EVAL-SDP-CB1Z Drivers Setup: Granting Permission to Install Drivers

4. To complete the drivers installation, click **Finish**, which closes the installation wizard.

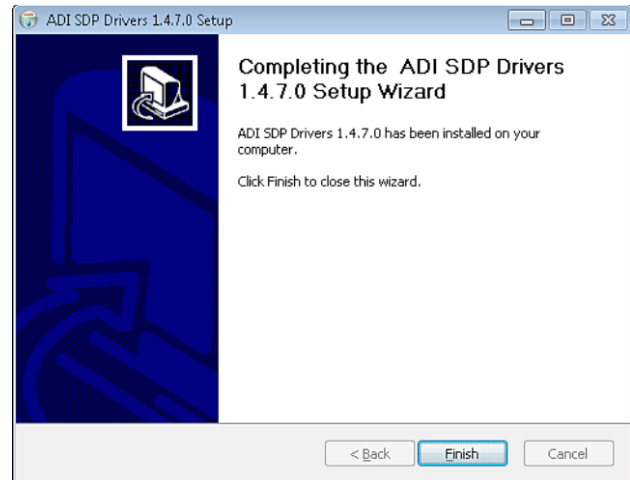

Figure 12. EVAL-SDP-CB1Z Drivers Setup: Completing the Drivers Setup Wizard

5. Before using the evaluation board, you must restart the computer.

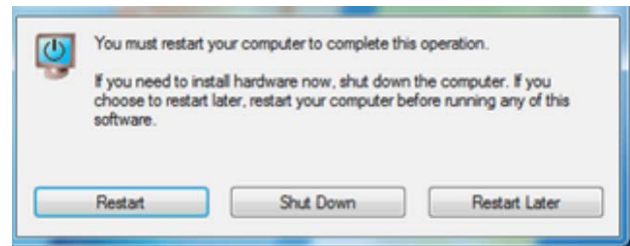

Figure 13. EVAL-SDP-CB1Z Drivers Setup: Restarting the Computer

SETTING UP THE SYSTEM FOR DATA CAPTURE

After completing the steps in the Software Installation Procedures and Evaluation Board Hardware sections, set up the system for data capture as follows:

1. Allow the **Found New Hardware Wizard** to run after the **EVAL-SDP-CBIZ** board is plugged into your PC. (If you are using Windows XP, you may need to search for the **EVAL-SDP-CBIZ** drivers. Choose to automatically search for the drivers for the **EVAL-SDP-CBIZ** board if prompted by the operating system.)
2. Check that the board is connecting to the PC correctly using the **Device Manager** of the PC.
 - a. Access the **Device Manager** as follows:
 - i. Right-click **My Computer** and then click **Manage**.
 - ii. A dialog box appears asking for permission to allow the program to make changes to your computer. Click **Yes**.
 - iii. The **Computer Management** box appears. Click **Device Manager** from the list of **System Tools** (see Figure 14).
 - b. The **EVAL-SDP-CBIZ** board should appear under **ADI Development Tools**. This indicates that the driver software is installed and that the board is connecting to the PC correctly.

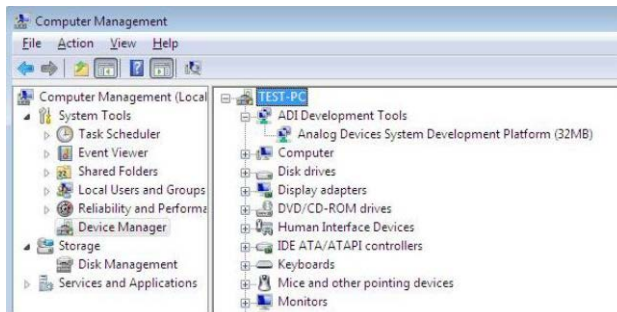

Figure 14. Device Manager: Checking That the Board Is Connected to the PC Correctly

Launching the Software

After completing the steps in the Setting Up the System for Data Capture section, launch the AD7124-8 software as follows:

1. From the **Start** menu, select **Programs > Analog Devices > AD7124-8 > AD7124-8 Evaluation Board Software**. The main window of the software then displays.
2. If the AD7124-8 evaluation system is not connected to the USB port via the **EVAL-SDP-CBIZ** when the software is launched, a connectivity error displays (see Figure 15). Connect the evaluation board to the USB port of the PC, wait a few seconds, click **Rescan**, and then follow the on-screen instructions.

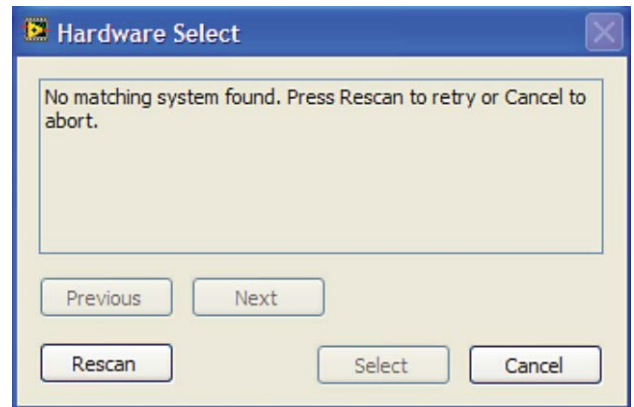

Figure 15. Connectivity Error Alert

When the software starts running, it searches for hardware connected to the PC. A dialog box indicates when the generic SDP attached to the PC is detected, and then the main window appears (see Figure 16).

SOFTWARE OPERATION

Overview of the Main Window

The main window of the software (see Figure 16) contains three tabs: Configure, Waveform and Histogram. Above the tabs, there are buttons that are used in all three tabs.

The **Configure** tab allows the user to setup the ADC, reset the ADC and read the diagnostics.

The **Waveform** tab graphs the conversions gathered and processes the data, calculating the p-p noise, rms noise and resolution.

The **Histogram** tab generates a histogram using the gathered samples and processes the data, calculating the p-p noise, rms noise and resolution.

Start Sampling Button

Clicking **Start Sampling**, located near the top right hand corner of the main window (see Figure 16), starts ADC sampling; results are reported in the graphs of the **Waveform** and **Histogram** sections. The software captures a specified number of samples, the sample size being set via the **Samples** box. The software can also continuously convert if the **Capture Defined Sample Set** is set to **Continuous**.

Delete Data/Clear Graphs

Clicking **Delete Data/Clear Graphs** clears the waveform graph and histogram and clears any conversion data gathered.

File

This allows you to write the current set of data to a file for later use, log data as it is gathered, and exit the program.

Help

This details the revision of the software.

Exiting the Software

To exit the software, click the red X at the top right hand corner of the main window. The software can also be exited using **File**.

Configure

ADC Setup Button

Clicking **ADC Setup** opens the **AD7124-8 Register Interface** window.

ADC Reset Button

Clicking **ADC Reset** resets the AD7124-8 so the registers are at their default (power-on reset) values.

Check Diagnostics Button

Clicking **Check Diagnostics** displays the current settings of the error bits in the Error register.

External Reference

This box displays the value of the external reference. It defaults to 2.5V since the AD4525 is a 2.5V reference. If a reference of a different value is used, update this box so that the software can correctly calculate the noise and resolution.

CRC Error Indicator

When the CRC is enabled, the software generates the CRC word for every write operation and checks the CRC value returned with any conversions or register values read. If a CRC error is detected in the communications between the software and the AD7124-8, the CRC Error LED becomes visible at the bottom of the window and is lit. The CRC functionality on the AD7124-8 is disabled by default.

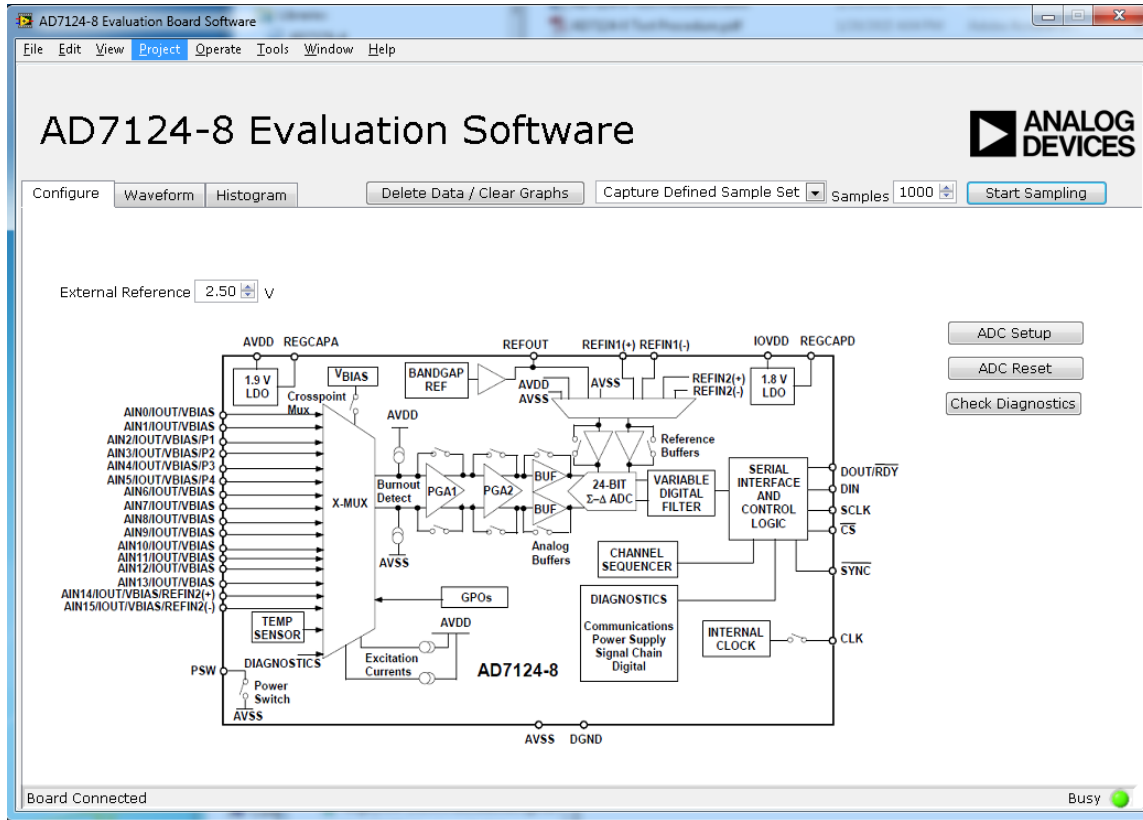

Figure 16. Main Window

Noise Test—Quick Start Demonstration

To perform a noise test using the AD7124-8 evaluation board, LK5 should be inserted so that AIN0 and AIN1 are connected together.

1. Click **ADC Setup** to open the **AD7124-8 Register Interface** window. The AD7124-8 should be configured as follows:
 - a. In the ADC_Control register, select the full power mode.
 - b. Provide a bias voltage to the analog input by enabling the VBIAS0 in the IO_Control_2 register.
 - c. In the Channel 0 register, AIN0 is connected to the positive input, AIN1 is connected to the negative input of the ADC for this channel, and Setup 0 is selected. Therefore, the AIN0 to AIN1 conversion is mapped using the Setup 0 configuration.
 - d. Setup 0 is configured with the following register settings:
 - i. In the Config_0 register, the external reference is selected as the reference source for the ADC conversion.
 - ii. In the Filter_0 register, FS0 is set to 2047 and the sinc4 filter is selected. This sets the output data rate to 9.38 sps.
 - iii. In the Offset_0 register, the default offset register value is selected.
 - iv. In the Gain_0 register, the factory trimmed gain error value is selected.
2. Figure 17 shows the contents of the **AD7124-8 Register Interface** and the state of the AD7124-8 registers. Click **OK** to return to the main window. Figure 18 shows an example of the main window after running a noise test.
3. Set the number of samples to be collected in each batch in the **Samples** box, which is located just to the left of **Start Sampling**, near the top right hand corner of the main window.
4. Click **Start Sampling** to acquire samples from the ADC.

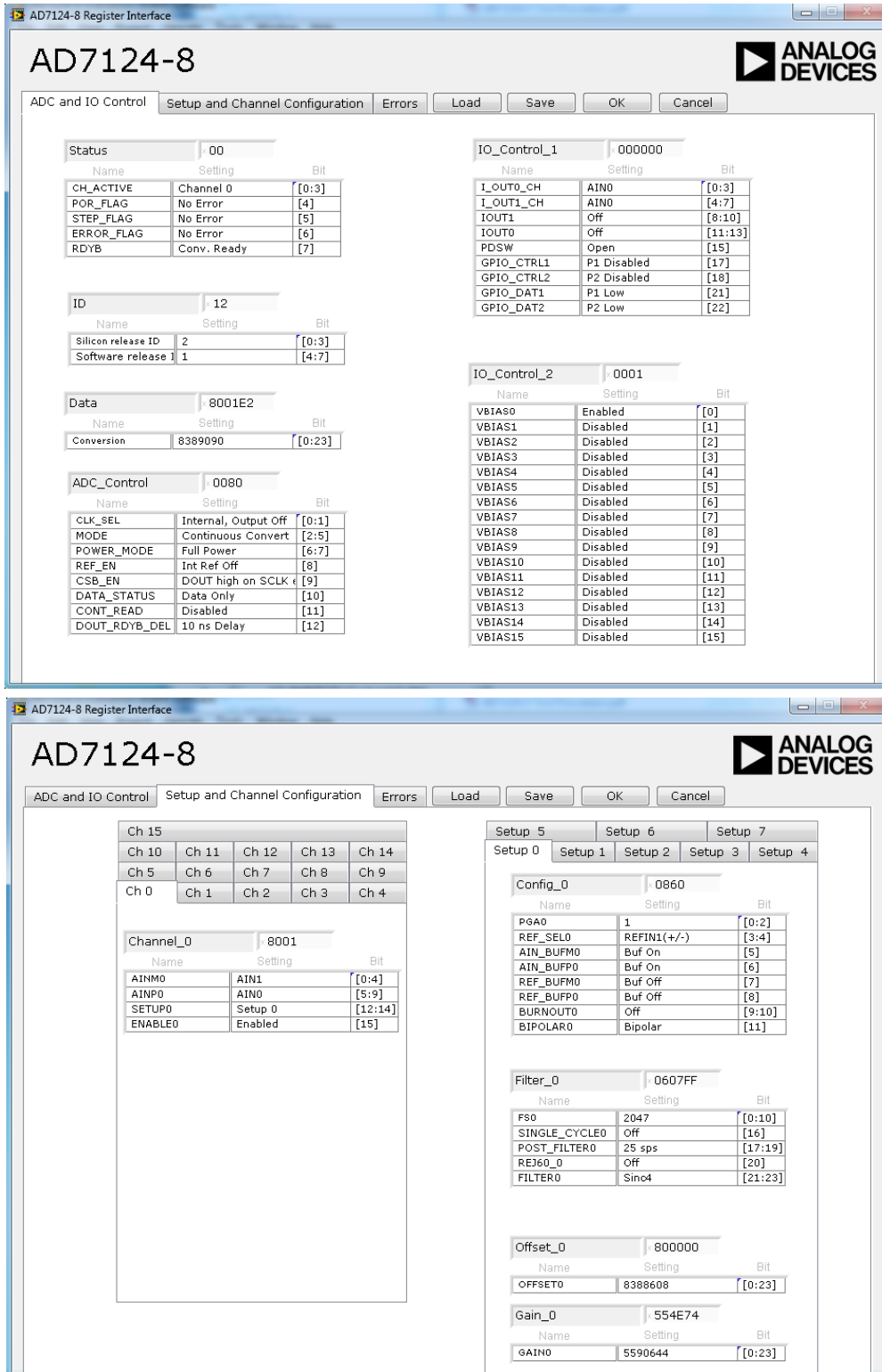

Figure 17. Configuration for Noise Test

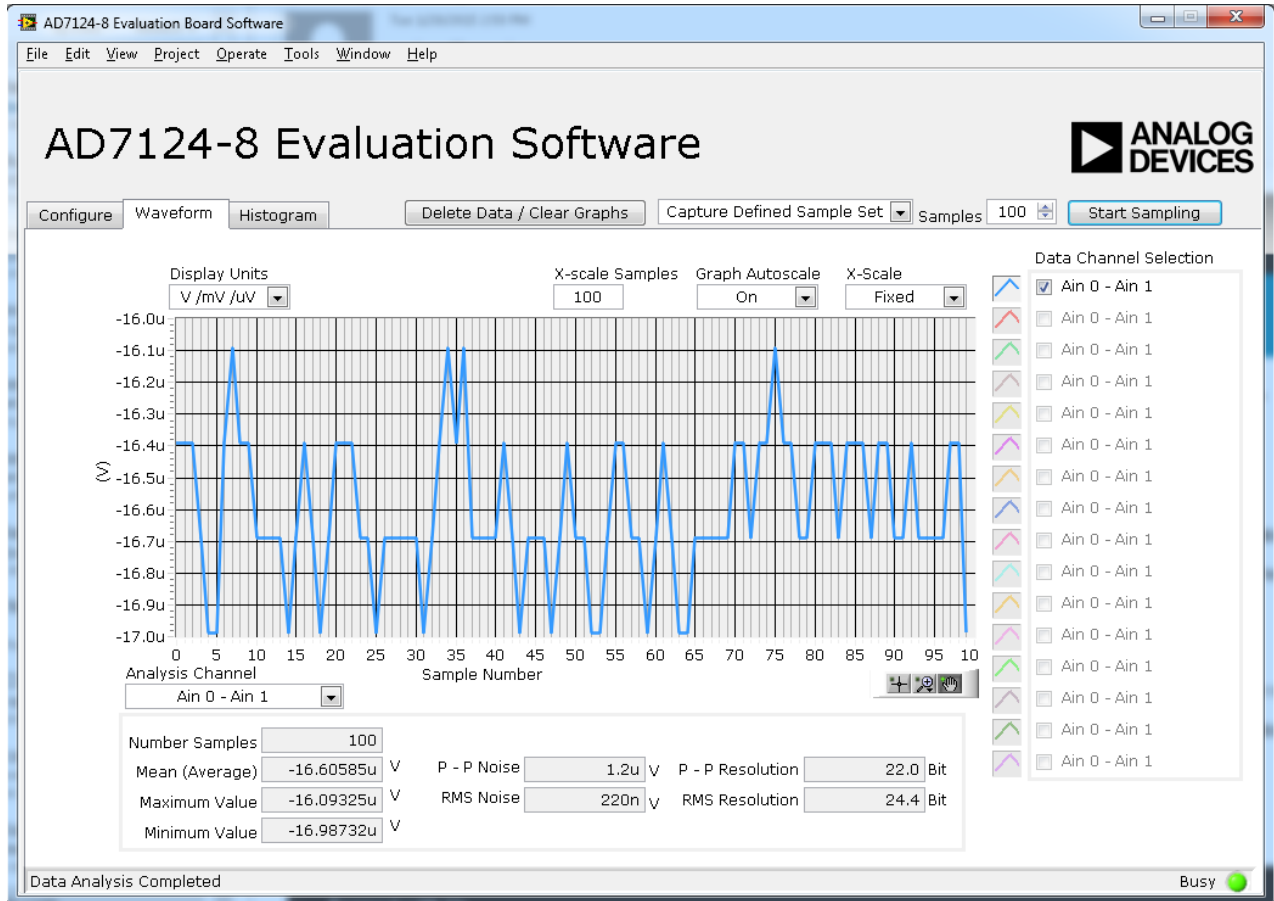

Figure 18. Example of the Main Window After Running a Noise Test

Reading Samples from the ADC

The evaluation board is set up to use the external 2.5 V on-board reference (ADR4525). To read samples from the ADC,

1. The value in the **Vref** box is set to 2.5 V by default to use the external 2.5 V on-board reference (ADR4525). If a different reference is used, such as the 2.5 V internal reference, set the value in the **Vref** box accordingly. (The analysis results are based on the value set in this box.)
2. Select the number of samples to analyze in the **Samples** box. (Note that when performing a continuous capture, this number is limited to 65,536 samples.)
3. When **Sampling** is set to **Capture**, a batch of samples is read when **Start Sampling** is clicked, with the batch size being set by the value in the **Samples** box. When **Sampling** is set to **Continuous**, the software performs a continuous capture from the ADC when **Start Sampling** is clicked.
4. Click **Stop** to stop streaming data.
5. Use the navigation tools within each graph to control the cursor, zooming, and panning.
6. If desired, save the current captured data for later analysis (see the **WaveformError! Reference source not found.** and the **Histogram** section).

Waveform

The waveforms resulting from the gathered samples are shown in the tab. The waveform graph shows each successive sample of the ADC output (input referred). The indicators beside this graph show the channels being converted. Navigation tools are provided to allow you to control the cursor, zooming, and panning. The conversions can be displayed as codes or as volts.

Parameters such as peak-to-peak noise and rms noise are displayed below the graph in the **Analysis** section for the current batch of samples. If several analog input channels are

enabled, each enabled channel can be selected and the conversions on that channel analysed using **Analysis Channel**.

The conversion data can be saved in a text file using **File** at the top of the window. To save the data into an Excel file, right-click on the waveform graph and select **Export Data** from the drop-down menu that appears. A **Save** dialog box is displayed, prompting you to save the data to an appropriate folder location.

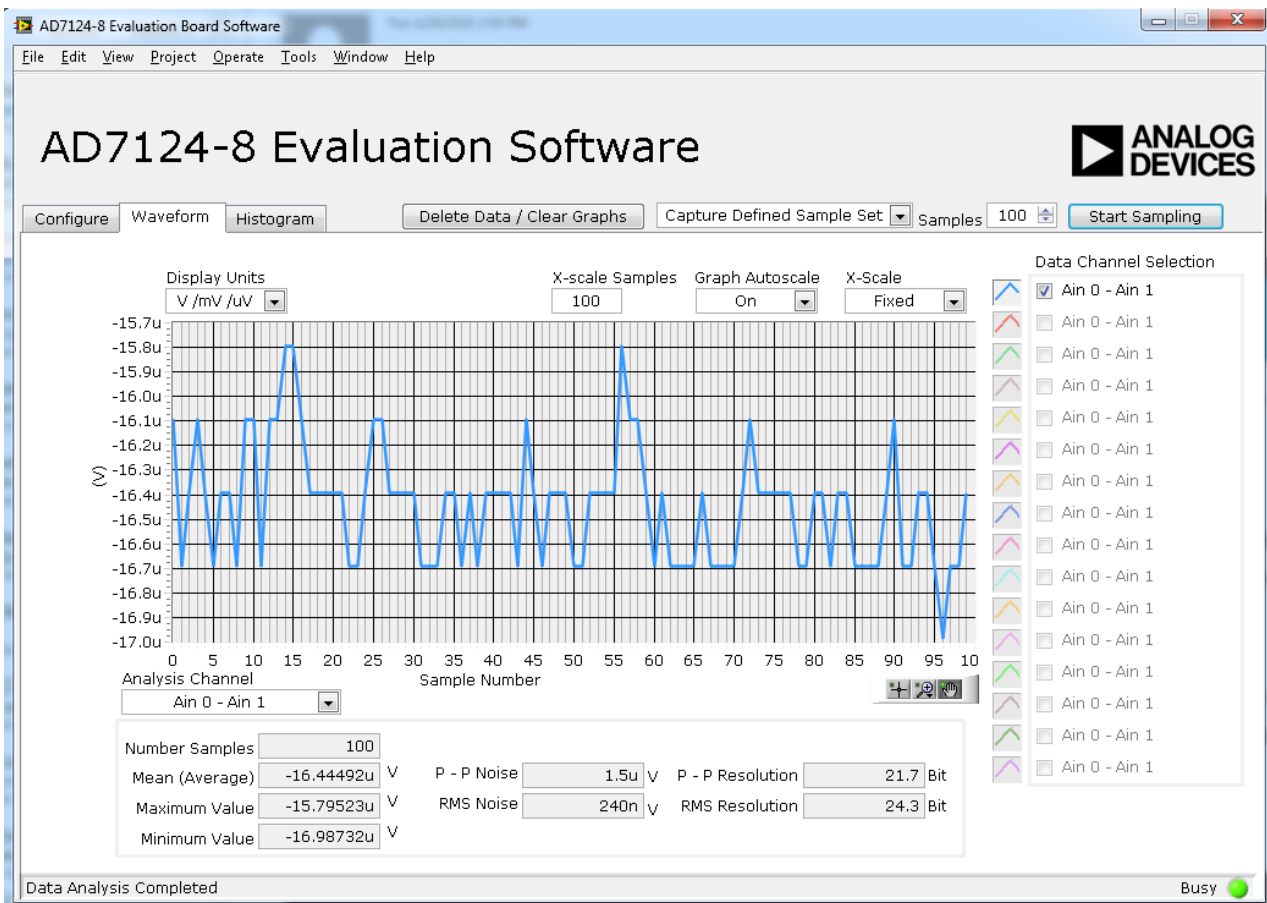

Figure 19. Waveform Analysis

Histogram

This tab shows the histogram analysis. The indicators beside this graph show the channels being converted. Navigation tools are provided to allow you to control the cursor, zooming, and panning. The conversions can be displayed as codes or as volts.

Parameters such as peak-to-peak noise and rms noise are displayed to the right of the graph in the **Analysis Results** section for the current batch of samples.

The conversion data can be saved in a text file using **File** at the top of the window. To save the data into an Excel file, right-click on the histogram graph and select **Export Data** from the drop-down menu that appears. A **Save** dialog box is displayed, prompting you to save the data to an appropriate folder location.

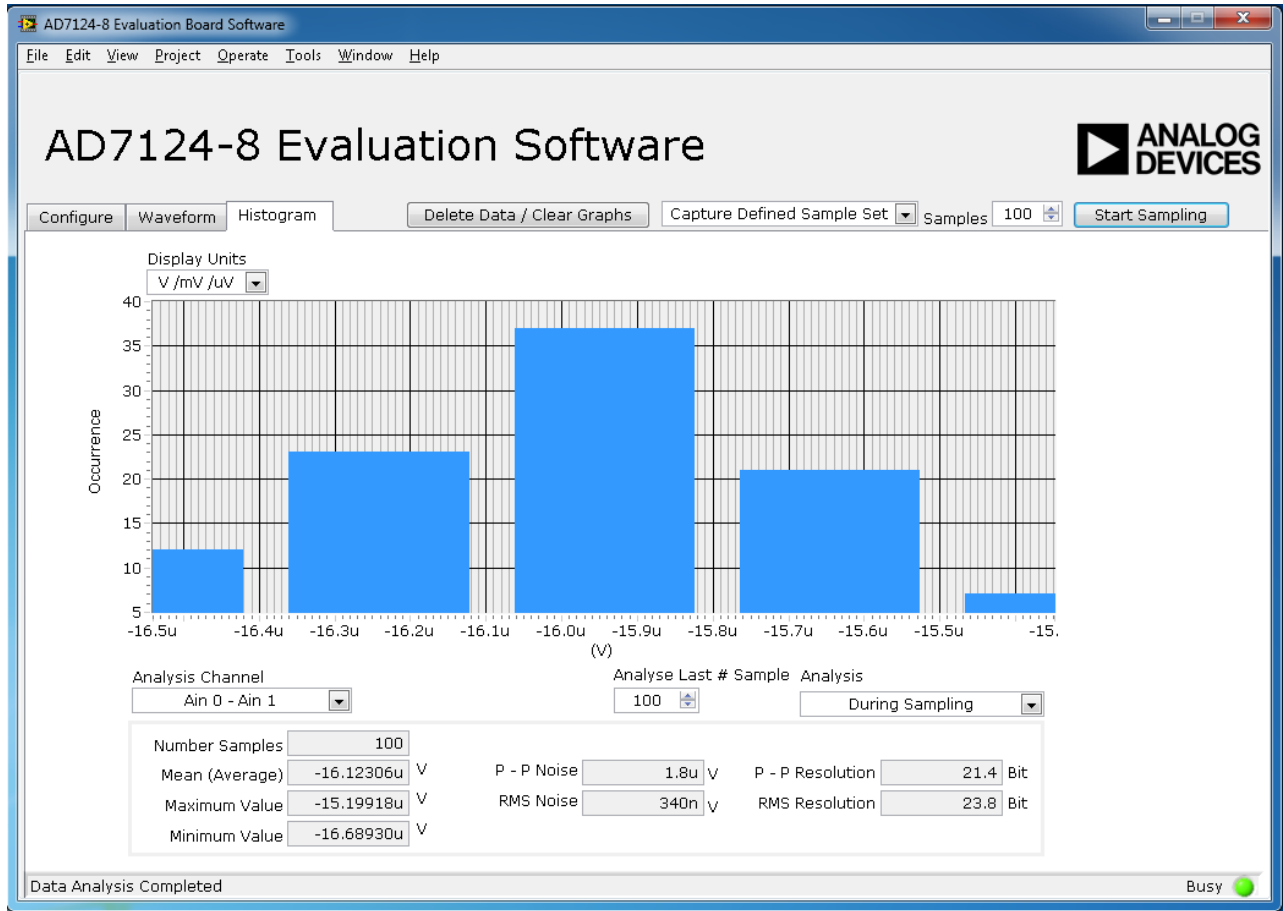

Figure 20. Histogram Analysis

EVALUATION BOARD SCHEMATICS AND ARTWORK

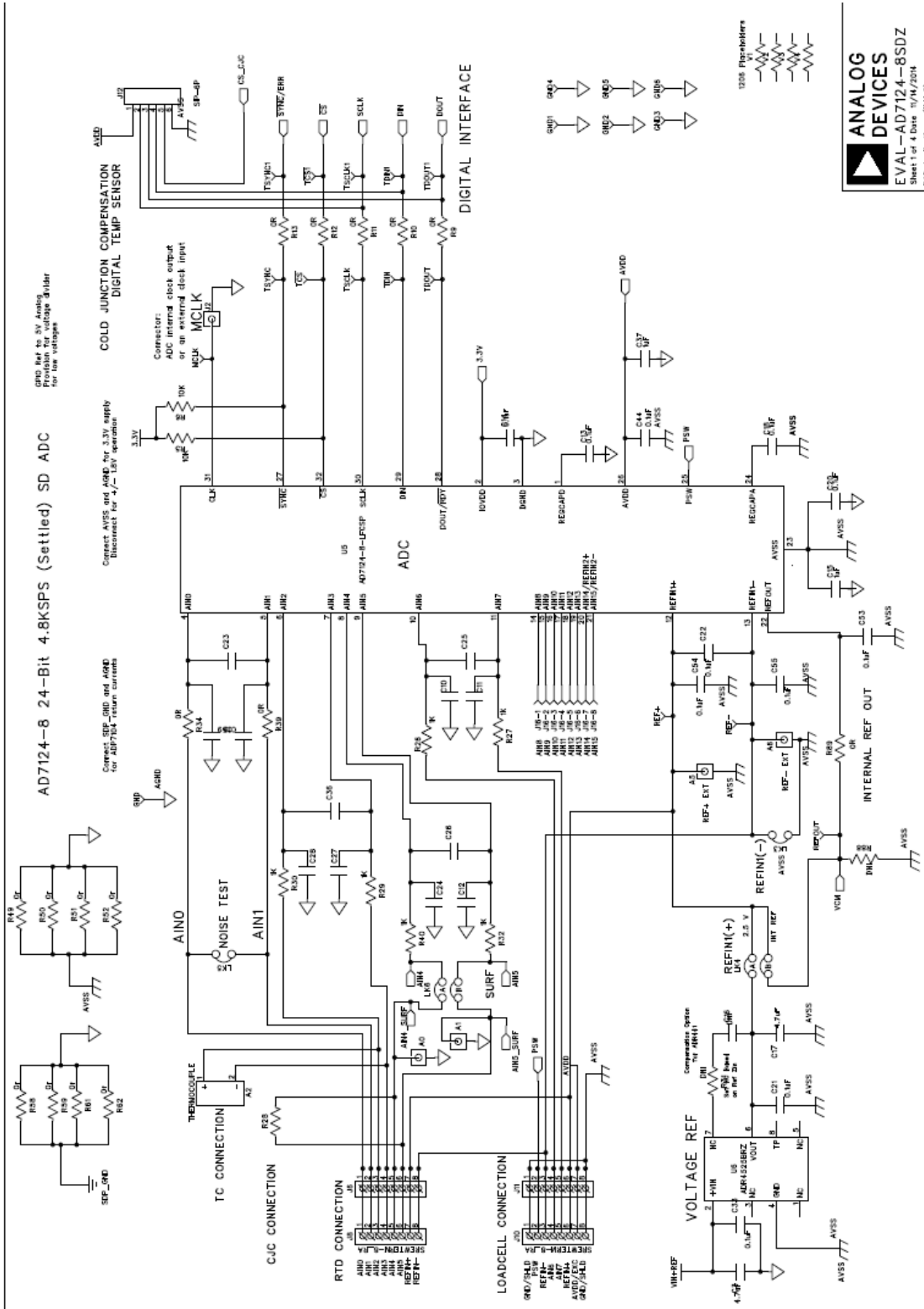

Figure 21. Schematic

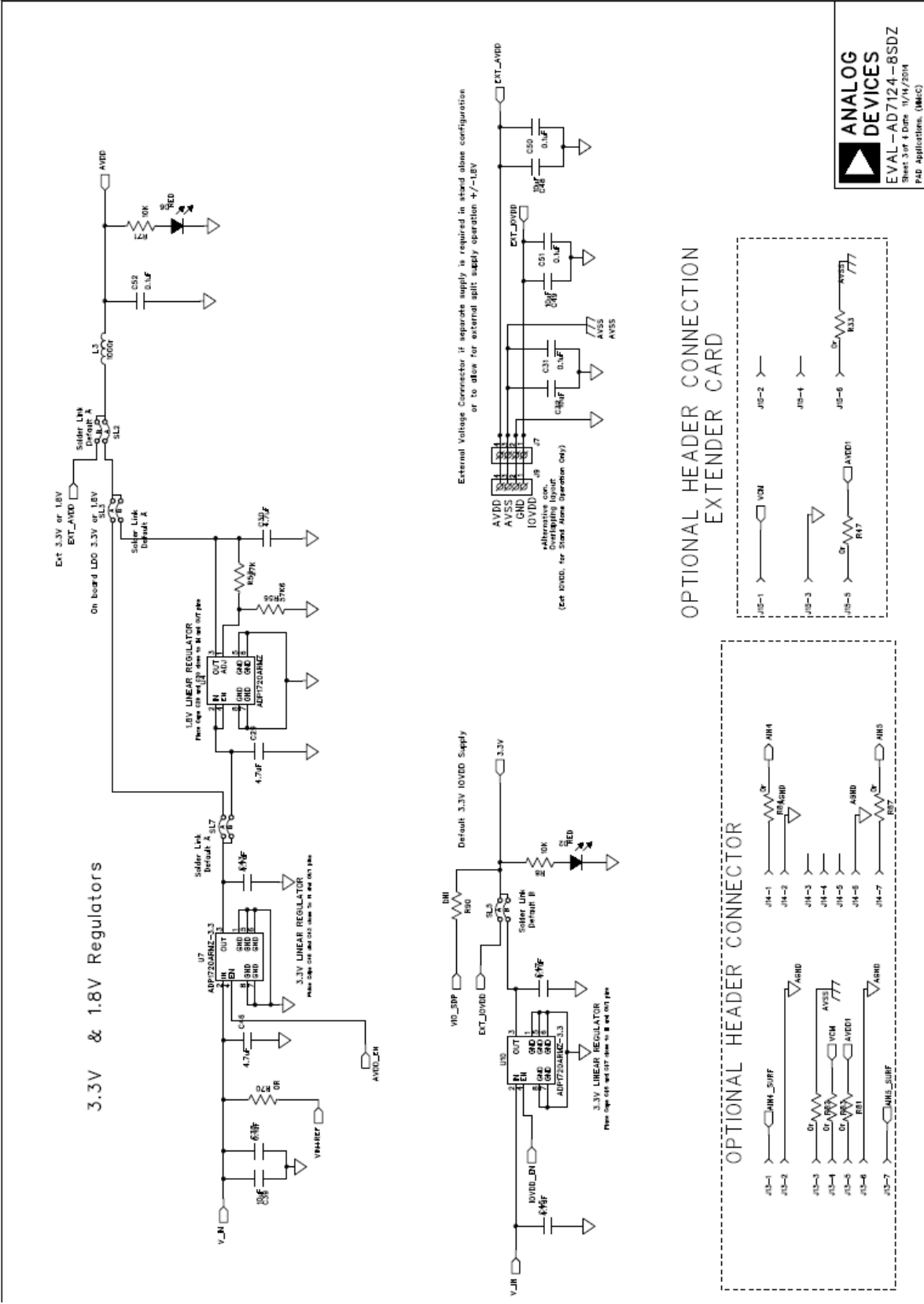
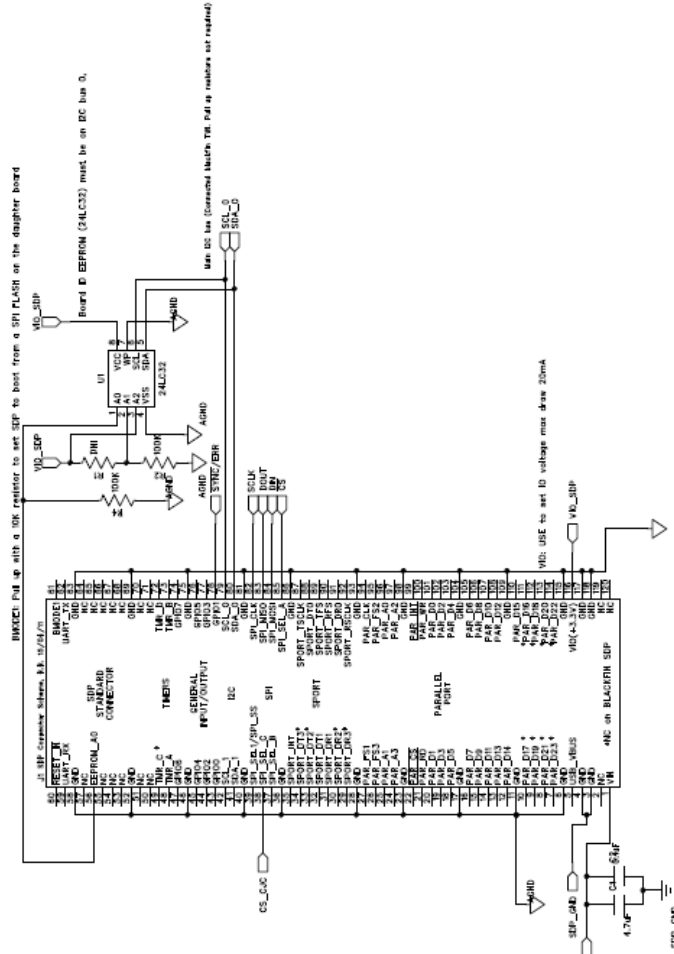

Figure 23. Schematic – Regulators

SDP CONNECTOR EEPROM-SW/USB ID

VB: Use to set the board to boot from a SPI FLASH on the daughter board.
 VN: Use the pin to power the SEP registers 4-7V 200mA.
 BKKEE: Pull up with a 10K resistor to set SEP to boot from a SPI FLASH on the daughter board.



ANALOG DEVICES
 EVAL-AD7124-8SDZ
 Sheet 4 of 4 Date: 11/14/2014
 PAD Applications, (M.C.) (PK)

VN: Use this pin to power the SEP registers 4V 200mA.
 BKKEE: Pull up with a 10K resistor to set SEP to boot from a SPI FLASH on the daughter board.
 (connected to BKKEE - use I2C_0 Trst)

Figure 24. Schematic - SDP

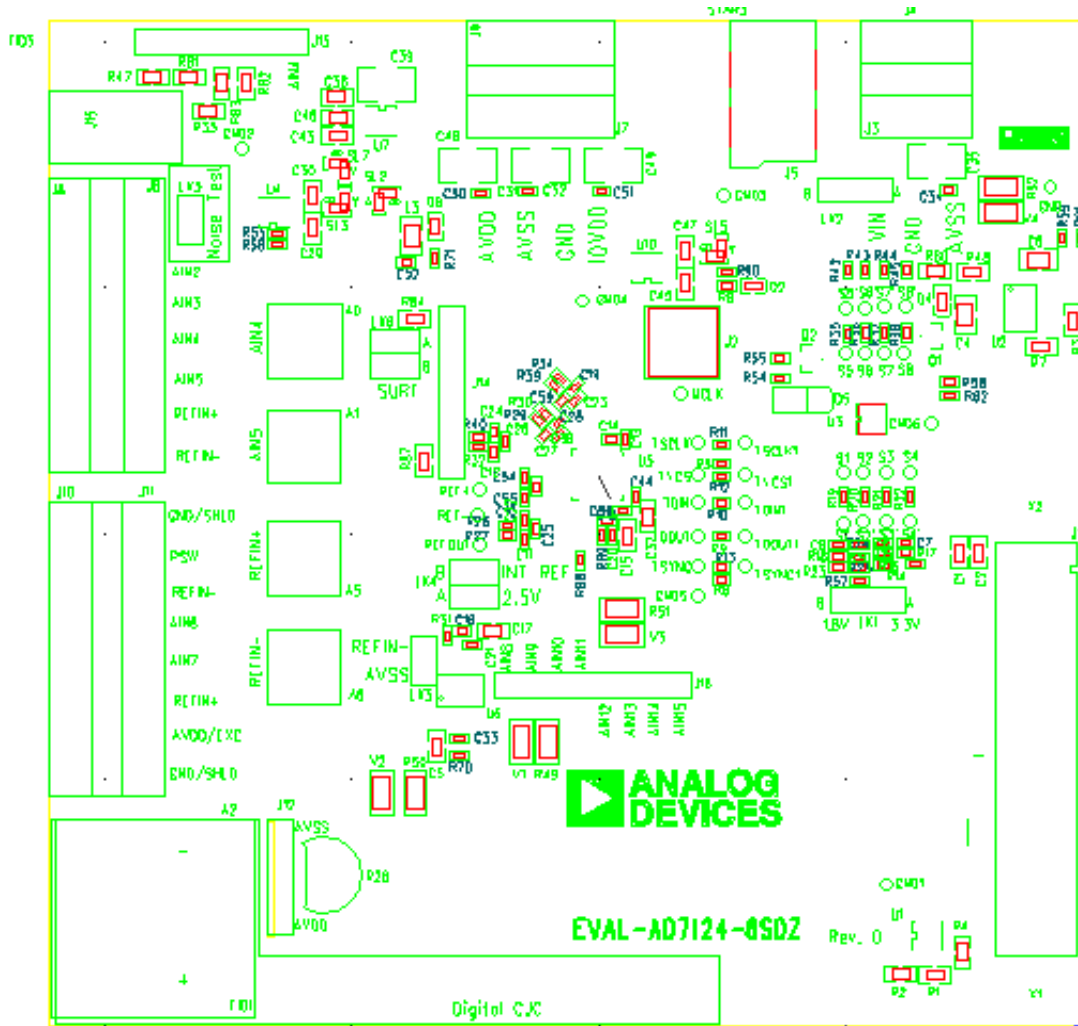

Figure 25. Top Printed Circuit Board (PCB) Silkscreen

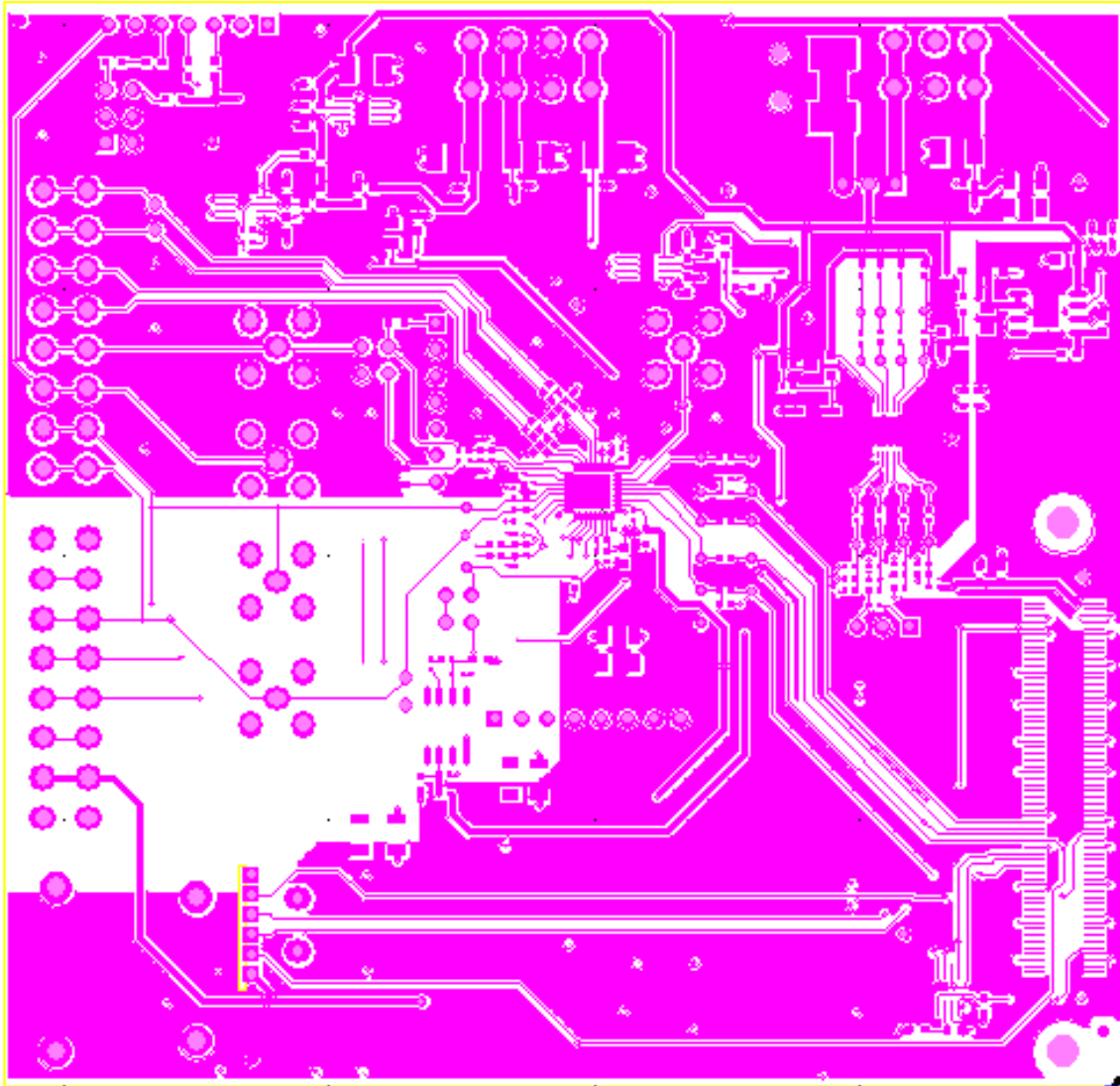

Figure 26. Layer 1 Component Side

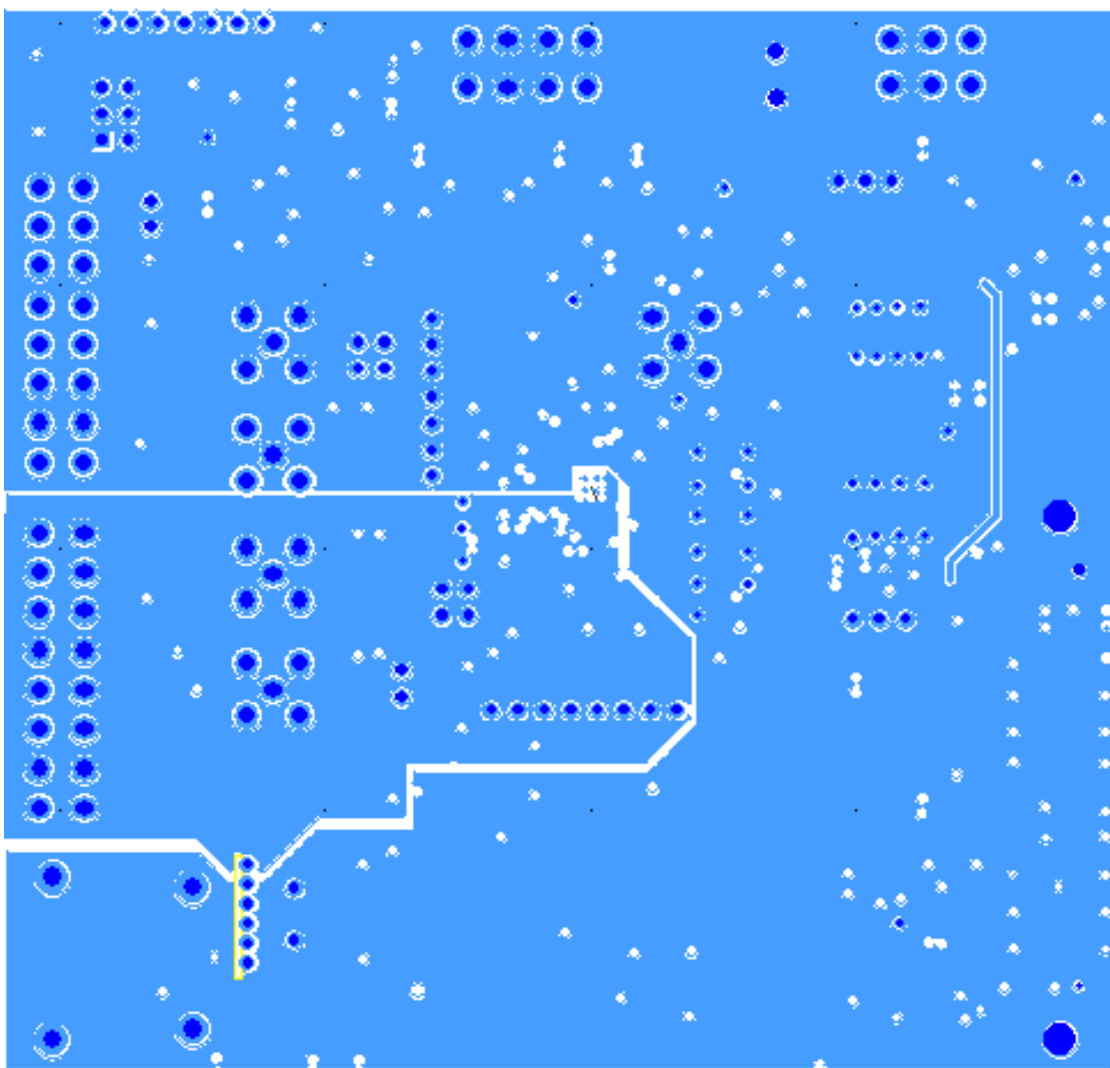

Figure 27. Layer 2 Ground Plane

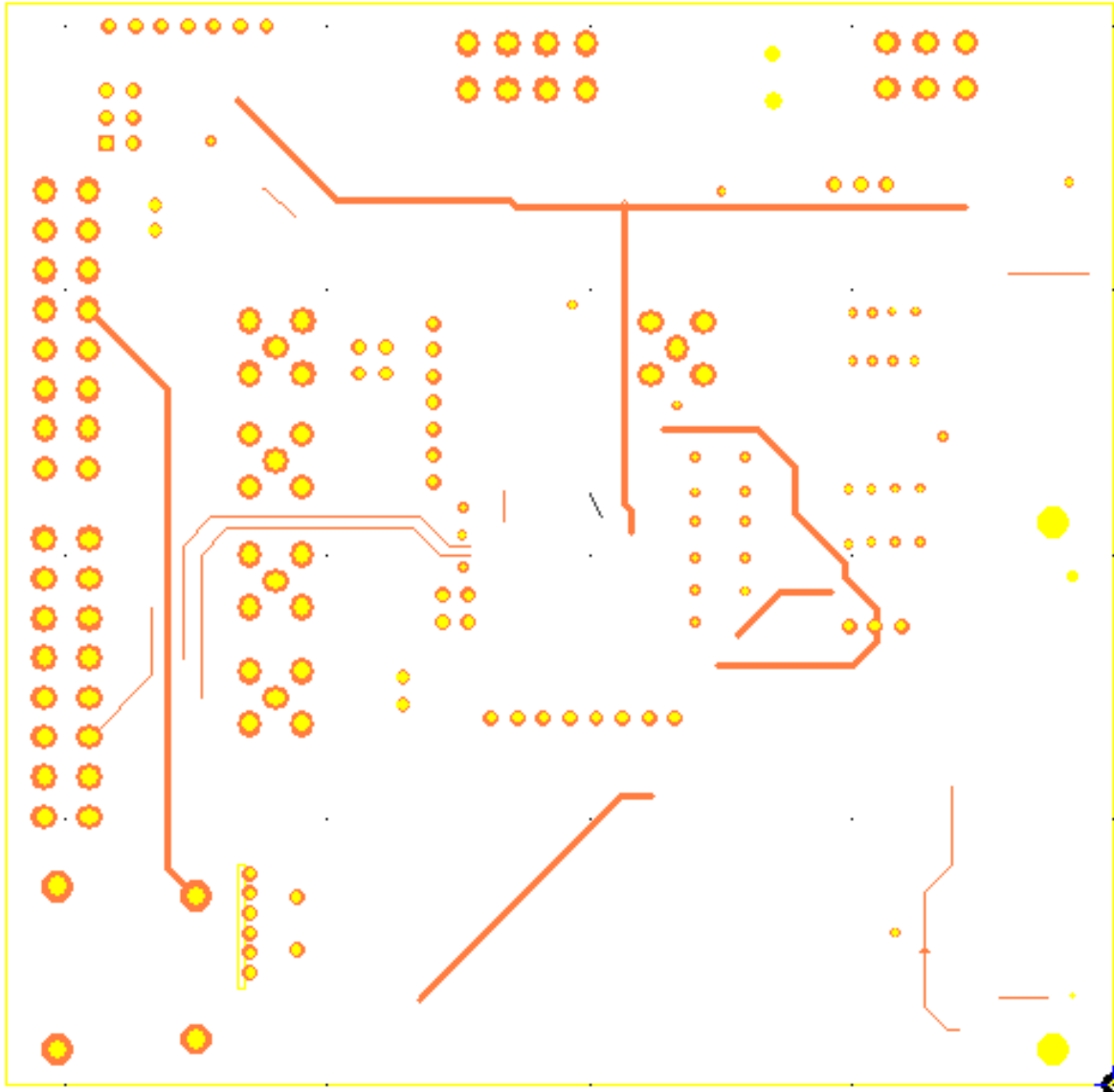

Figure 28. Layer 3 Power/Ground Plane

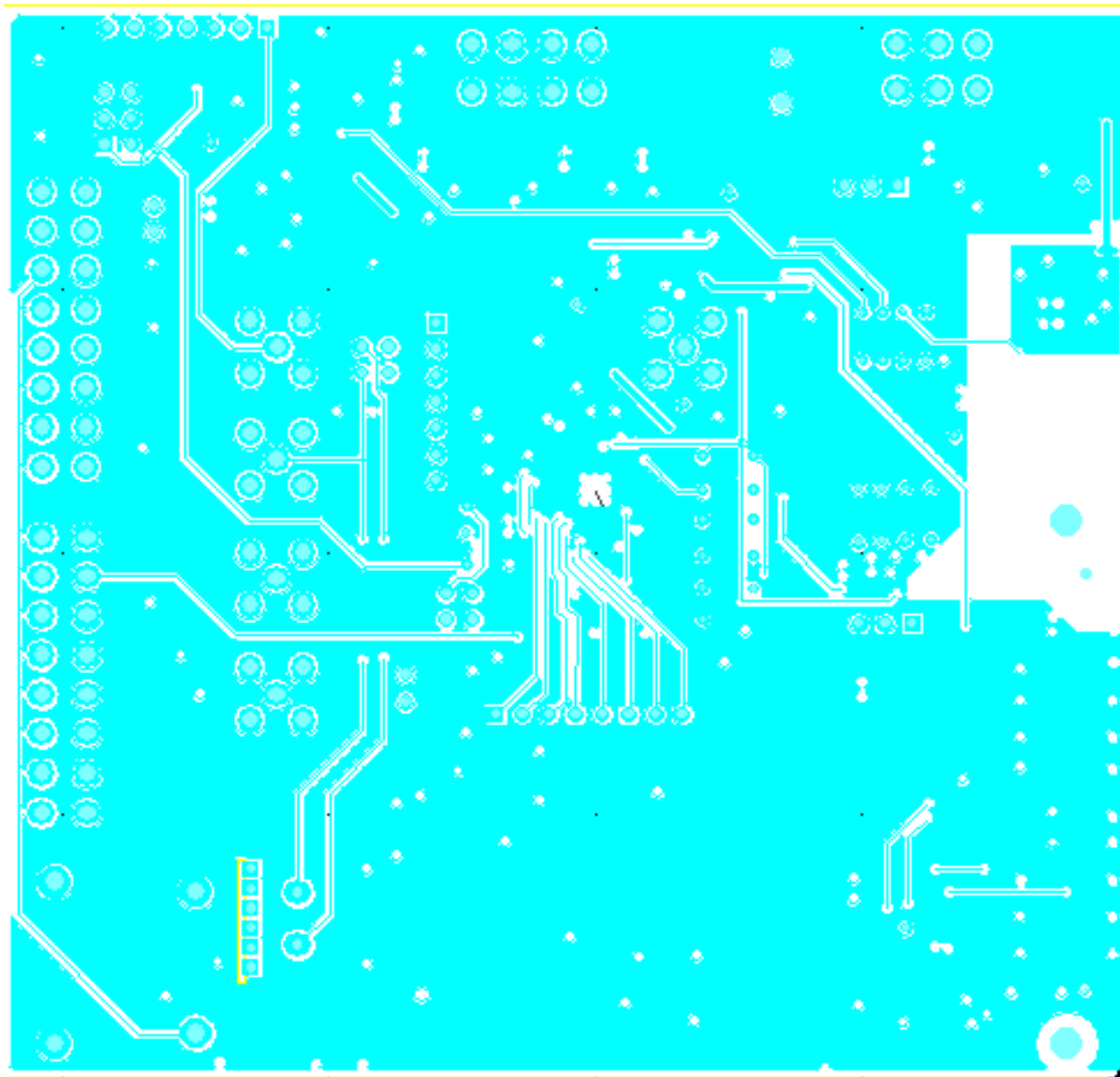

Figure 29. Layer 4 Component Side

EVAL-AD7124-8SDZ BILL OF MATERIALS

Table 4.

Name	Value	Tolerance	PCB Decal	PART DESC	MFG	Part Number	STOCK CODE
A0			SMA	Straight PCB Mount SMB Jack, keep hole clear of solder	Tyco	1-1337482-0	Do Not Insert
A1			SMA	Straight PCB Mount SMB Jack, keep hole clear of solder	Tyco	1-1337482-0	Do Not Insert
A2			THERMOCOUPLE	Miniature Thermocouple Connector	Omega	PCC-SMP-U-50	Do Not Insert
A5			SMA	Straight PCB Mount SMB Jack, keep hole clear of solder	Tyco	1-1337482-0	Do Not Insert
A6			SMA	Straight PCB Mount SMB Jack, keep hole clear of solder	Tyco	1-1337482-0	Do Not Insert
C1	4.7uF	±10%	C0603	Capacitor ceramic, 6.3V, X5R, 0603	Murata	GRM188R60J475K	FEC 173-5527
C2	0.1uF	±10%	C0603	Capacitor ceramic, 50V, X7R, 0603	Murata	GRM188R71H104K	FEC 882-0023
C3	4.7uF	±10%	C0603	Capacitor ceramic, 10V, X5R, 0603	Kemet	C0603C475K8PACTU	FEC 157-2625
C4	1uF	±10%	C0805	CAPACITOR, 0805, 1UF, 50V, X7R	MURATA	GRM21BR71H105KA12L	FEC 173-5541
C5	DNI	TBD	C0402	Ceramic Capacitor, not inserted, 0402	n/a	n/a	Do Not Insert
C6	1uF	±10%	C0805	CAPACITOR, 0805, 1UF, 50V, X7R	MURATA	GRM21BR71H105KA12L	FEC 173-5541
C7	DNI	TBD	C0402	Ceramic Capacitor, not inserted, 0402	n/a	n/a	Do Not Insert
C8	DNI	TBD	C0402	Ceramic Capacitor, not inserted, 0402	n/a	n/a	Do Not Insert
C9	DNI	TBD	C0402	Ceramic Capacitor, not inserted, 0402	n/a	n/a	Do Not Insert
C10	0.01uF	TBD	C0402	Ceramic Capacitor, 50V, NPO, 0603	Phycomp	2238 586 15636	FEC 722-236
C11	0.01uF	TBD	C0402	Ceramic Capacitor, 50V, NPO, 0603	Phycomp	2238 586 15636	FEC 722-236
C12	0.01uF	TBD	C0402	Ceramic Capacitor, 50V, NPO, 0603	Phycomp	2238 586 15636	FEC 722-236
C13	0.1uF	±10%	C0402	Capacitor ceramic, 16V, X7R, 0402	Murata	GRM155R71C104K	FEC 881-9742
C14	0.1uF	±10%	C0402	Capacitor ceramic, 16V, X7R, 0402	Murata	GRM155R71C104K	FEC 881-9742
C15	1uF	±10%	C0603	Capacitor, 6.3V	Murata	GRM188R70J105KA01D	FEC 184-5765
C16	DNI	TBD	C0402	Ceramic Capacitor, not inserted, 0402	n/a	n/a	Do Not Insert
C17	4.7uF	±10%	C0603	Capacitor ceramic, 6.3V, X5R, 0603	Murata	GRM188R60J475K	FEC 173-5527
C18	0.1uF	±10%	C0402	Capacitor ceramic, 16V, X7R, 0402	Murata	GRM155R71C104K	FEC 881-9742
C19	0.01uF	TBD	C0402	Ceramic Capacitor, 25V, NPO, 0603	n/a	n/a	Do Not Insert
C20	0.1uF	±10%	C0402	Capacitor ceramic, 16V, X7R, 0402	Murata	GRM155R71C104K	FEC 881-9742
C21	0.1uF	±10%	C0402	Capacitor ceramic, 16V, X7R, 0402	Murata	GRM155R71C104K	FEC 881-9742

C22	0.1uF	±10%	C0402	Capacitor ceramic, 50V, X7R, 0603	Murata	GRM188R71H 104K	FEC 882-0023
C23	0.1uF	TBD	C0402	Ceramic Capacitor, 50V, NPO, 0603	n/a	n/a	Do Not Insert
C24	0.01uF	TBD	C0402	Capacitor ceramic, 50V, X7R, 0603	Phycomp	2238 586 15636	FEC 722-236
C25	0.1uF	TBD	C0402	Capacitor ceramic, 50V, X7R, 0603	Murata	GRM188R71H 104K	FEC 882-0023
C26	0.1uF	TBD	C0402	Capacitor ceramic, 50V, X7R, 0603	Murata	GRM188R71H 104K	FEC 882-0023
C27	0.01uF	TBD	C0402	Ceramic Capacitor, 50V, NPO, 0603	Phycomp	2238 586 15636	FEC 722-236
C28	0.01uF	TBD	C0402	Ceramic Capacitor, 50V, NPO, 0603	Phycomp	2238 586 15636	FEC 722-236
C29	4.7uF	±10%	C0603	Capacitor ceramic, 6.3V, X5R, 0603	Murata	GRM188R60J4 75K	FEC 173-5527
C30	4.7uF	±10%	C0603	Capacitor ceramic, 6.3V, X5R, 0603	Murata	GRM188R60J4 75K	FEC 173-5527
C31	0.1uF	±10%	C0402	Capacitor ceramic, 16V, X7R, 0402	Murata	GRM155R71C 104K	FEC 881-9742
C32	10uF	TBD	1210	Capacitor ceramic, 50V, X5R, 1210	Murata	GRM32ER61H 106K	FEC 184-5764
C33	0.1uF	±10%	C0402	Capacitor ceramic, 16V, X7R, 0402	Murata	GRM155R71C 104K	FEC 881-9742
C34	0.1uF	±10%	C0402	Capacitor ceramic, 16V, X7R, 0402	Murata	GRM155R71C 104K	FEC 881-9742
C35	10uF	TBD	1210	Capacitor ceramic, 50V, X5R, 1210	Murata	GRM32ER61H 106K	FEC 184-5764
C36	0.1uF	±10%	C0402	Capacitor ceramic, 50V, X7R, 0603	Murata	GRM188R71H 104K	FEC 882-0023
C37	1uF	±10%	C0603	Capacitor, 0603, 6.3V	Murata	GRM188R70J1 05KA01D	FEC 184-5765
C38	0.1uF	±10%	C0603	Capacitor ceramic, 50V, X7R, 0603	Murata	GRM188R71H 104K	FEC 882-0023
C39	10uF	TBD	1210	Capacitor ceramic, 50V, X5R, 1210	Murata	GRM32ER61H 106K	FEC 184-5764
C43	4.7uF	±10%	C0603	Capacitor ceramic, 6.3V, X5R, 0603	Murata	GRM188R60J4 75K	FEC 173-5527
C44	0.1uF	±10%	C0402	Capacitor ceramic, 16V, X7R, 0402	Murata	GRM155R71C 104K	FEC 881-9742
C45	4.7uF	±10%	C0603	Capacitor ceramic, 10V, X5R, 0603	Kemet	C0603C475K8 PACTU	FEC 157-2625
C46	4.7uF	±10%	C0603	Capacitor ceramic, 10V, X5R, 0603	Kemet	C0603C475K8 PACTU	FEC 157-2625
C47	4.7uF	±10%	C0603	Capacitor ceramic, 6.3V, X5R, 0603	Murata	GRM188R60J4 75K	FEC 173-5527
C48	10uF	TBD	1210	Capacitor ceramic, 50V, X5R, 1210	Murata	GRM32ER61H 106K	FEC 184-5764
C49	10uF	TBD	1210	Capacitor ceramic, 50V, X5R, 1210	Murata	GRM32ER61H 106K	FEC 184-5764
C50	0.1uF	±10%	C0402	Capacitor ceramic, 16V, X7R, 0402	Murata	GRM155R71C 104K	FEC 881-9742
C51	0.1uF	±10%	C0402	Capacitor ceramic, 16V, X7R, 0402	Murata	GRM155R71C 104K	FEC 881-9742
C52	0.1uF	±10%	C0402	Capacitor ceramic, 16V, X7R, 0402	Murata	GRM155R71C 104K	FEC 881-9742
C53	0.1uF	±10%	C0402	Capacitor ceramic, 16V, X7R, 0402	Murata	GRM155R71C 104K	FEC 881-9742

C54	0.1uF	±10%	C0603	Capacitor ceramic, 50V, X7R, 0603	Murata	GRM188R71H 104K	FEC 882-0023
C55	0.1uF	±10%	C0603	Capacitor ceramic, 50V, X7R, 0603	Murata	GRM188R71H 104K	FEC 882-0023
C59	0.01uF	TBD	C0402	Ceramic Capacitor, 25V, NPO, 0603	n/a	n/a	Do Not Insert
D2	RED		LED-0603HSML-C191	Red LED, high intensity (>90mCd), 0603	Avago Tech.	HSMC-C191	FEC 855-8528
D4	GREEN		LED-0603	LED, SMD Green	OSRAM	LGQ971	Digikey 475-1409-1-ND
D5	BZT52		SOD-123	DIODE, ZENER, 0.5W, 5.1V	Vishay	BZT52B5V1-V-GS08	FEC 161-7767
D6	RED		LED-0603HSML-C191	Red LED, high intensity (>90mCd), 0603	Avago Tech.	HSMC-C191	FEC 855-4528
GND			TESTPOINT-SMALL	Test point, not inserted, keep hole clear of solder	n/a	n/a	Do Not Insert
GND1			TESTPOINT-SMALL	Test point, not inserted, keep hole clear of solder	n/a	n/a	Do Not Insert
GND2			TESTPOINT-SMALL	Test point, not inserted, keep hole clear of solder	n/a	n/a	Do Not Insert
GND3			TESTPOINT-SMALL	Test point, not inserted, keep hole clear of solder	n/a	n/a	Do Not Insert
GND4			TESTPOINT-SMALL	Test point, not inserted, keep hole clear of solder	n/a	n/a	Do Not Insert
GND5			TESTPOINT-SMALL	Test point, not inserted, keep hole clear of solder	n/a	n/a	Do Not Insert
GND6			TESTPOINT-SMALL	Test point, not inserted, keep hole clear of solder	n/a	n/a	Do Not Insert
J1			CON-120/FX8-120S-SV	120-way connector, 0.6mm pitch	Hirose	FX8-120S-SV(21)	FEC 132-4660
J2			SMB	Straight PCB Mount SMB Jack, keep hole clear of solder	Tyco	1-1337482-0	Do Not Insert
J3			CON\POWER3(3_81PITCH)	Socket terminal block, pitch 3.81mm	Phoenix Contact	MC 1.5/3-G-3.81	FEC 370-4737
J4			CON\POWER3(3_81PITCH)	Screw terminal block, pitch 3.81mm	Phoenix Contact	1727023	Do Not Insert
J5			CON\BARREL_SMD_2MM_KLDX-SMT2-0202-A	DC Power Connectors 2mm SMT POWER JACK	KYCON	KLDX-SMT2-0202-A	MOUSER 806-KLDX-SMT20202A
J6			CON\POWER8(3_81PITCH)	8-Pin Terminal header, pitch 3.81mm, vertical	Phoenix Contact	MC 1,5/ 8-G-3,81	FEC 370-4774
J7	1x4-pin		CON\POWER4(3_81PITCH)	Connector, pitch 3.81mm, right angle	Phoenix Contact	MC 1,5/ 4-G-3,81 & 180-3594	Do Not Insert
J8			CON\POWER8(3_81PITCH)	8-Pin Terminal header, pitch 3.81mm, vertical	Phoenix Contact	1727078	Do Not Insert
J9	1x4-pin		CON\POWER4(3_81PITCH)	Screw terminal block, pitch 3.81mm	Phoenix Contact	1727036	FEC 370-4592

J10			CON\POWE R8(3_81PITC H)	8-Pin Terminal header, pitch 3.81mm, vertical	Phoenix Contact	1727078	Do Not Insert
J11			CON\POWE R8(3_81PITC H)	8-Pin Terminal header, pitch 3.81mm, vertical	Phoenix Contact	MC 1,5/ 8-G- 3,81	FEC 370-4774
J12	6-Way		SIP-6P- P1.9MM	PCB Pads, 6-Way Solder Slot for ADI PCB	Aragorn	ADT7320-CJC- PCB	ADT7320-CJC- PCB
J13			SIP-7P	7 WAY SSW 2.54mm Vert. Socket	Samtec	SSW-107-01-T- S	FEC 180-3478
J14			SIP-7P	7 Way Sip 2.54mm TH Header	Samtec	TLW-107-05- G-S	FEC 166-8499
J15			HEADER06- SKT-RA				Do not insert
L3	1000r		805	Ferrite bead, 0.3ohm@DC, 1000@100MHz, 350mA, 0805	TYCO	BMB2A1000L N2	FEC 119-3421
LK1			LINK-3P	3 Pin (3x1) 0.1" Header & Shorting Block in A	Harwin	M20-9990346 & M7566-05	FEC 102-2249 & 150-411
LK2			LINK-3P	3 Pin (3x1) 0.1" Header & Shorting Block in A	Harwin	M20-9990346 & M7566-05	FEC 102-2249 & 150-411
LK3			SIP-2P	2 Pin (0.1" Pitch) Header & Shorting Shunt	Harwin	M20-9990246	FEC 102-2247 & 150-411
LK4			JUMPER_2_I NVTEXT	4 Pin (2X2) 0.1" Header & Shorting Block	Harwin	M20-9983646 & M7566-05	FEC 1022244 & 150-411 (36 Pin Strip)
LK5			SIP-2P	2 Pin (0.1" Pitch) Header & Shorting Shunt	Harwin	M20-9990246	FEC 102-2247 & 150-411
LK6			JUMPER_2	4 Pin (2X2) 0.1" Header & Shorting Block	Harwin	M20-9983646 & M7566-05	FEC 1022244 & 150-411 (36 Pin Strip)
MCLK			TESTPOINT- SMALL	Test point, not inserted, keep hole clear of solder	n/a	n/a	Do Not Insert
Q1			SOT23	MOSFET Transistor	Vishay Siliconix	SI2304DDS- T1-GE3	FEC 185-8939
Q2			SOT23	TRANSISTOR, NPN, SOT-23	ON SEMICONDUCT OR	MMBT3904LT 1G	FEC 145-9100
R1	DNI		R0603	Resistor, not inserted, 0603	n/a	n/a	Do Not Insert
R2	100K	0.01	R0603	SMD Resistor	Multicomp	MC 0.063W 0603 1% 100K	FEC 933-0402
R3	100K	0.01	R0603	SMD Resistor	Multicomp	MC 0.063W 0603 1% 100K	FEC 933-0402
R4	100K	0.01	R0603	SMD Resistor	Multicomp	MC 0.063W 0603 1% 100K	FEC 933-0402
R5	10K	0.01	R0402	Resistor, 1%, 0402	Phycomp	CRCW040210 KOFKEAHP	FEC 173-8864
R6	10K	0.01	R0402	Resistor, 1%, 0402	Phycomp	CRCW040210 KOFKEAHP	FEC 173-8864
R7	100K	0.01	R0603	SMD Resistor	Multicomp	MC 0.063W 0603 1% 100K	FEC 933-0402
R8	10K	0.01	R0402	Resistor, 1%, 0402	Phycomp	CRCW040210 KOFKEAHP	FEC 173-8864
R9	OR	0.01	R0402	Resistor, 0402	Vishay	CRCW0402000 OZ0ED	FEC 146-9661
R10	OR	0.01	R0402	Resistor, 0402	Vishay	CRCW0402000 OZ0ED	FEC 146-9661
R11	OR	0.01	R0402	Resistor, 0402	Vishay	CRCW0402000 OZ0ED	FEC 146-9661

R12	0R	0.01	R0402	Resistor, 0402	Vishay	CRCW0402000 0Z0ED	FEC 146-9661
R13	0R	0.01	R0402	Resistor, 0402	Vishay	CRCW0402000 0Z0ED	FEC 146-9661
R14	30K	0.01	R0402	Resistor, 0402, 1%, 30K	Multicomp	MC 0.0625W 0402 1% 30K	FEC 135-8082
R15	10K2	0.01	R0402	SMD Resistor	Multicomp	MC 0.0625W 0402 1% 10K2	FEC 180-3137
R16	69K8	0.01	R0402	Resistor, 0402, 1%, 69K8	Multicomp	MC 0.0625W 0402 1% 69K8	FEC 180-3735
R17	10K2	0.01	R0402	SMD Resistor	Multicomp	MC 0.0625W 0402 1% 10K2	FEC 180-3137
R18	10K2	0.01	R0402	SMD Resistor	Multicomp	MC 0.0625W 0402 1% 10K2	FEC 180-3137
R19	0R	0.01	R0402	Resistor, 0402	Vishay	CRCW0402000 0Z0ED	FEC 146-9661
R20	0R	0.01	R0402	Resistor, 0402	Vishay	CRCW0402000 0Z0ED	FEC 146-9661
R21	0R	0.01	R0402	Resistor, 0402	Vishay	CRCW0402000 0Z0ED	FEC 146-9661
R22	0R	0.01	R0402	Resistor, 0402	Vishay	CRCW0402000 0Z0ED	FEC 146-9661
R23	86K6	0.01	R0402	RESISTOR, 0402, 1%, 86K6	MULTICOMP	MC 0.0625W 0402 1% 86K6	FEC 180-3744
R24	10K2	0.01	R0402	SMD Resistor Resistor, 0402	Multicomp	MC 0.0625W 0402 1% 10K2	FEC 180-3137
R25	15K	0.01	R0402	RESISTOR, 0402, 1%, 15k	MULTICOMP	MC 0.0625W 0402 1% 15k	FEC 1358073
R26	1K	1%	R0402	Resistor, 0603	Multicomp	MC 0.063W 0603 1% 1K	FEC 933-0380
R27	1K	1%	R0402	Resistor, 0603	Multicomp	MC 0.063W 0603 1% 1K	FEC 933-0380
R28	1950r- 1990r		TO-92- MODIFIED	Thermistor	Infineon	Q62705-K110	Philips (Arrow) KTY81/110
R29	1K	1%	R0402	Resistor, 0603	Multicomp	MC 0.063W 0603 1% 1K	FEC 933-0380
R30	1K	1%	R0402	Resistor, 0603	Multicomp	MC 0.063W 0603 1% 1K	FEC 933-0380
R31	DNI		R0402	Resistor, not inserted, 0402	n/a	n/a	Do Not Insert
R32	1K	1%	R0402	Resistor, 0603	Multicomp	MC 0.063W 0603 1% 1K	FEC 933-0380
R33	0R	0.01	R0603	Resistor, 0603	Vishay Draloric	CRCW0603000 0Z0EA	FEC 146-9739
R34	0R	0.01	R0603	Resistor, 0603	Vishay Draloric	CRCW0603000 0Z0EA	FEC 146-9739
R35	0R	0.01	R0402	Resistor, 0402	Vishay	CRCW0402000 0Z0ED	FEC 146-9661
R36	0R	0.01	R0402	Resistor, 0402	Vishay	CRCW0402000 0Z0ED	FEC 146-9661
R37	0R	0.01	R0402	Resistor, 0402	Vishay	CRCW0402000 0Z0ED	FEC 146-9661
R38	0R	0.01	R0402	Resistor, 0402	Vishay	CRCW0402000 0Z0ED	FEC 146-9661
R39	0R	0.01	R0603	Resistor, 0603	Vishay Draloric	CRCW0603000 0Z0EA	FEC 146-9739
R40	1K	1%	R0603	Resistor, 0603	Multicomp	MC 0.063W 0603 1% 1K	FEC 933-0380

R42	10K	0.05	R0402	Resistor, Thick Film, 10Kohm, 62.5mW, 5%	Yageo	RC0402JR-1310KL	FEC 179-9316
R43	10K	0.05	R0402	Resistor, Thick Film, 10Kohm, 62.5mW, 5%	Yageo	RC0402JR-1310KL	FEC 179-9316
R44	10K	0.05	R0402	Resistor, Thick Film, 10Kohm, 62.5mW, 5%	Yageo	RC0402JR-1310KL	FEC 179-9316
R45	10K	0.05	R0402	Resistor, Thick Film, 10Kohm, 62.5mW, 5%	Yageo	RC0402JR-1310KL	FEC 179-9316
R47	0R	0.01	R0603	Resistor, 0603	Vishay Draloric	CRCW06030000Z0EA	FEC 146-9739
R48	100K	0.01	R0603	SMD Resistor	Multicomp	MC 0.063W 0603 1% 100K	FEC 933-0402
R49	0R	0.05	1206	Resistor, 1206	Multicomp	MC 0.125W 1206 0R	FEC 933-6974
R50	0R	0.05	1206	Resistor, 1206	Multicomp	MC 0.125W 1206 0R	FEC 933-6974
R51	0R	0.05	1206	Resistor, 1206	Multicomp	MC 0.125W 1206 0R	FEC 933-6974
R52	0R	0.05	1206	Resistor, 1206	Multicomp	MC 0.125W 1206 0R	FEC 933-6974
R53	27K	0.01	R0402	Resistor, 0402, 27K	Multicomp	MC 0.0625W 0402 1% 27K	FEC 135-8081
R54	4K53	0.01	R0402	Resistor, Thick Film, 4.53Kohm, 63mW, 1%	Vishay Dale	CRCW04024K53FKED	FEC 115-1244
R55	61R9	0.01	R0402	Resistor, 0402, 1%, 61R9	Multicomp	MC 0.0625W 0402 1% 61R9	FEC 180-2915
R56	57K6	0.01	R0402	Resistor, 0402, 57K6	Multicomp	MC 0.0625W 0402 1% 57K6	FEC 185-1295
R57	15K	0.01	R0402	Resistor, 0402, 1%, 15K	Multicomp	MC 0.0625W 0402 1% 15K	FEC 135-8073
R58	0R	0.01	R0402	Resistor, 0402	Vishay	CRCW04020000Z0ED	FEC 146-9661
R59	0R	0.01	R0402	Resistor, 0402	Vishay	CRCW04020000Z0ED	FEC 146-9661
R60	2K4	0.01	R0603	Resistor, Thick Film, 2.4K, 0603, 100mW, 1%	Yageo	RC0603FR-072K4L	FEC 179-9329
R61	0R	0.01	R0402	Resistor, 0402	Vishay	CRCW04020000Z0ED	FEC 146-9661
R62	0R	0.01	R0402	Resistor, 0402	Vishay	CRCW04020000Z0ED	FEC 146-9661
R70	0R	0.01	R0402	Resistor, 0402	Vishay	CRCW04020000Z0ED	FEC 146-9661
R71	10K	0.01	R0402	Resistor, 1%, 0402	Phycomp	CRCW040210K0FKEAHP	FEC 173-8864
R81	0R	0.01	R0603	Resistor, 0603	Vishay Draloric	CRCW06030000Z0EA	FEC 146-9739
R82	0R	0.01	R0603	Resistor, 0603	Vishay Draloric	CRCW06030000Z0EA	FEC 146-9739
R83	0R	0.01	R0603	Resistor, 0603	Vishay Draloric	CRCW06030000Z0EA	FEC 146-9739
R84	0R	0.01	R0603	Resistor, 0603	Vishay Draloric	CRCW06030000Z0EA	FEC 146-9739
R87	0R	0.01	R0603	Resistor, 0603	Vishay Draloric	CRCW06030000Z0EA	FEC 146-9739
R88	DNI		R0402	Resistor, 0603, not inserted	n/a	n/a	Do Not Insert
R89	0R	0.01	R0603	Resistor, 0603	Vishay Draloric	CRCW06030000Z0EA	FEC 146-9739

R90	DNI		R0402	Resistor, 0402	n/a	n/a	Do Not Insert
REF+			TESTPOINT-SMALL	Test point, not inserted, keep hole clear of solder	n/a	n/a	Do Not Insert
REF-			TESTPOINT-SMALL	Test point, not inserted, keep hole clear of solder	n/a	n/a	Do Not Insert
REFOUT			TESTPOINT-SMALL	Test point, not inserted, keep hole clear of solder	n/a	n/a	Do Not Insert
S1			TESTPOINT-SMALL	Test point, not inserted, keep hole clear of solder	n/a	n/a	Do Not Insert
S1'			TESTPOINT-SMALL	Test point, not inserted, keep hole clear of solder	n/a	n/a	Do Not Insert
S2			TESTPOINT-SMALL	Test point, not inserted, keep hole clear of solder	n/a	n/a	Do Not Insert
S2'			TESTPOINT-SMALL	Test point, not inserted, keep hole clear of solder	n/a	n/a	Do Not Insert
S3			TESTPOINT-SMALL	Test point, not inserted, keep hole clear of solder	n/a	n/a	Do Not Insert
S3'			TESTPOINT-SMALL	Test point, not inserted, keep hole clear of solder	n/a	n/a	Do Not Insert
S4			TESTPOINT-SMALL	Test point, not inserted, keep hole clear of solder	n/a	n/a	Do Not Insert
S4'			TESTPOINT-SMALL	Test point, not inserted, keep hole clear of solder	n/a	n/a	Do Not Insert
S5			TESTPOINT-SMALL	Test point, not inserted, keep hole clear of solder	n/a	n/a	Do Not Insert
S5'			TESTPOINT-SMALL	Test point, not inserted, keep hole clear of solder	n/a	n/a	Do Not Insert
S6			TESTPOINT-SMALL	Test point, not inserted, keep hole clear of solder	n/a	n/a	Do Not Insert
S6'			TESTPOINT-SMALL	Test point, not inserted, keep hole clear of solder	n/a	n/a	Do Not Insert
S7			TESTPOINT-SMALL	Test point, not inserted, keep hole clear of solder	n/a	n/a	Do Not Insert
S7'			TESTPOINT-SMALL	Test point, not inserted, keep hole clear of solder	n/a	n/a	Do Not Insert
S8			TESTPOINT-SMALL	Test point, not inserted, keep hole clear of solder	n/a	n/a	Do Not Insert
S8'			TESTPOINT-SMALL	Test point, not inserted, keep hole clear of solder	n/a	n/a	Do Not Insert
SL2			0603-2WAY-BRIDGE	2-way Solder Link (Use Or 0603 Resistor)	n/a	Insert in Link Position "A"	FEC 933-1662
SL3			0603-2WAY-BRIDGE	2-way Solder Link (Use Or 0603 Resistor)	n/a	Insert in Link Position "A"	FEC 933-1662
SL5			0603-2WAY-BRIDGE	2-way Solder Link (Use Or 0603 Resistor)	n/a	Insert in Link Position "B"	FEC 933-1662
SL7			0603-2WAY-BRIDGE	2-way Solder Link (Use Or 0603 Resistor)	n/a	Insert in Link Position "A"	FEC 933-1662
STAR3			COMPONENT LINK	Ground Link	n/a	n/a	n/a
TDIN			TESTPOINT-SMALL	Test point, not inserted, keep hole clear of solder	n/a	n/a	Do Not Insert
TDIN1			TESTPOINT-SMALL	Test point, not inserted, keep hole clear of solder	n/a	n/a	Do Not Insert
TDOUT			TESTPOINT-SMALL	Test point, not inserted, keep hole clear of solder	n/a	n/a	Do Not Insert
TDOUT 1			TESTPOINT-SMALL	Test point, not inserted, keep hole clear of solder	n/a	n/a	Do Not Insert

TSCLK			TESTPOINT-SMALL	Test point, not inserted, keep hole clear of solder	n/a	n/a	Do Not Insert
TSCLK1			TESTPOINT-SMALL	Test point, not inserted, keep hole clear of solder	n/a	n/a	Do Not Insert
TSYNC			TESTPOINT-SMALL	Test point, not inserted, keep hole clear of solder	n/a	n/a	Do Not Insert
TSYNC1			TESTPOINT-SMALL	Test point, not inserted, keep hole clear of solder	n/a	n/a	Do Not Insert
T\CS			TESTPOINT-SMALL	Test point, not inserted, keep hole clear of solder	n/a	n/a	Do Not Insert
T\CS1			TESTPOINT-SMALL	Test point, not inserted, keep hole clear of solder	n/a	n/a	Do Not Insert
U1			MSO8	32K I2C Serial EEPROM	Microchip	24LC32A-I/MS	FEC133-1330
U2			SO8NB_RD8-2	Linear Regulator 5V, 20V, 500mA, Ultralow Noise, CMOS	Analog Devices	ADP7104ARD-Z-5.0	ADP7104ARDZ-5.0
U3			MSO10	Quad Voltage Monitor and Sequencer	Analog Devices	ADM1185ARM-Z-1	ADM1185ARMZ-1
U4			MSO8	50 mA, High Voltage, Micropower Linear Regulator - ADJ	Analog Devices	ADP1720ARM-Z-R7	ADP1720ARMZ-R7
U5			LFCSP-32	4 Channel, Low Power, Low Noise, Sigma Delta ADC	Analog Devices	AD7124-8BCPZ	AD7124-8BCPZ
U6			SO8NB	2.5V low noise Reference	Analog Devices	ADR4525BRZ	ADR4525BRZ
U7			MSO8	50 mA, High Voltage, Micropower Linear Regulator - 3.3V	Analog Devices	ADP1720ARM-Z-3.3-R7	ADP1720ARMZ-3.3-R7
U10			MSO8	50 mA, High Voltage, Micropower Linear Regulator - 3.3V	Analog Devices	ADP1720ARM-Z-3.3-R7	ADP1720ARMZ-3.3-R7
V1			R1206	1206 Place Holder	n/a	n/a	Do Not Insert
V2			R1206	1206 Place Holder	n/a	n/a	Do Not Insert
V3			R1206	1206 Place Holder	n/a	n/a	Do Not Insert
V4			R1206	1206 Place Holder	n/a	n/a	Do Not Insert

**ESD Caution**

ESD (electrostatic discharge) sensitive device. Charged devices and circuit boards can discharge without detection. Although this product features patented or proprietary protection circuitry, damage may occur on devices subjected to high energy ESD. Therefore, proper ESD precautions should be taken to avoid performance degradation or loss of functionality.

Legal Terms and Conditions

By using the evaluation board discussed herein (together with any tools, components documentation or support materials, the "Evaluation Board"), you are agreeing to be bound by the terms and conditions set forth below ("Agreement") unless you have purchased the Evaluation Board, in which case the Analog Devices Standard Terms and Conditions of Sale shall govern. Do not use the Evaluation Board until you have read and agreed to the Agreement. Your use of the Evaluation Board shall signify your acceptance of the Agreement. This Agreement is made by and between you ("Customer") and Analog Devices, Inc. ("ADI"), with its principal place of business at One Technology Way, Norwood, MA 02062, USA. Subject to the terms and conditions of the Agreement, ADI hereby grants to Customer a free, limited, personal, temporary, non-exclusive, non-sublicensable, non-transferable license to use the Evaluation Board FOR EVALUATION PURPOSES ONLY. Customer understands and agrees that the Evaluation Board is provided for the sole and exclusive purpose referenced above, and agrees not to use the Evaluation Board for any other purpose. Furthermore, the license granted is expressly made subject to the following additional limitations: Customer shall not (i) rent, lease, display, sell, transfer, assign, sublicense, or distribute the Evaluation Board; and (ii) permit any Third Party to access the Evaluation Board. As used herein, the term "Third Party" includes any entity other than ADI, Customer, their employees, affiliates and in-house consultants. The Evaluation Board is NOT sold to Customer; all rights not expressly granted herein, including ownership of the Evaluation Board, are reserved by ADI. CONFIDENTIALITY. This Agreement and the Evaluation Board shall all be considered the confidential and proprietary information of ADI. Customer may not disclose or transfer any portion of the Evaluation Board to any other party for any reason. Upon discontinuation of use of the Evaluation Board or termination of this Agreement, Customer agrees to promptly return the Evaluation Board to ADI. ADDITIONAL RESTRICTIONS. Customer may not disassemble, decompile or reverse engineer chips on the Evaluation Board. Customer shall inform ADI of any occurred damages or any modifications or alterations it makes to the Evaluation Board, including but not limited to soldering or any other activity that affects the material content of the Evaluation Board. Modifications to the Evaluation Board must comply with applicable law, including but not limited to the RoHS Directive. TERMINATION. ADI may terminate this Agreement at any time upon giving written notice to Customer. Customer agrees to return to ADI the Evaluation Board at that time. LIMITATION OF LIABILITY. THE EVALUATION BOARD PROVIDED HEREUNDER IS PROVIDED "AS IS" AND ADI MAKES NO WARRANTIES OR REPRESENTATIONS OF ANY KIND WITH RESPECT TO IT. ADI SPECIFICALLY DISCLAIMS ANY REPRESENTATIONS, ENDORSEMENTS, GUARANTEES, OR WARRANTIES, EXPRESS OR IMPLIED, RELATED TO THE EVALUATION BOARD INCLUDING, BUT NOT LIMITED TO, THE IMPLIED WARRANTY OF MERCHANTABILITY, TITLE, FITNESS FOR A PARTICULAR PURPOSE OR NON-INFRINGEMENT OF INTELLECTUAL PROPERTY RIGHTS. IN NO EVENT WILL ADI AND ITS LICENSORS BE LIABLE FOR ANY INCIDENTAL, SPECIAL, INDIRECT, OR CONSEQUENTIAL DAMAGES RESULTING FROM CUSTOMER'S POSSESSION OR USE OF THE EVALUATION BOARD, INCLUDING BUT NOT LIMITED TO LOST PROFITS, DELAY COSTS, LABOR COSTS OR LOSS OF GOODWILL. ADI'S TOTAL LIABILITY FROM ANY AND ALL CAUSES SHALL BE LIMITED TO THE AMOUNT OF ONE HUNDRED US DOLLARS (\$100.00). EXPORT. Customer agrees that it will not directly or indirectly export the Evaluation Board to another country, and that it will comply with all applicable United States federal laws and regulations relating to exports. GOVERNING LAW. This Agreement shall be governed by and construed in accordance with the substantive laws of the Commonwealth of Massachusetts (excluding conflict of law rules). Any legal action regarding this Agreement will be heard in the state or federal courts having jurisdiction in Suffolk County, Massachusetts, and Customer hereby submits to the personal jurisdiction and venue of such courts. The United Nations Convention on Contracts for the International Sale of Goods shall not apply to this Agreement and is expressly disclaimed.

©2013 Analog Devices, Inc. All rights reserved. Trademarks and registered trademarks are the property of their respective owners.



www.analog.com