

CKT. SIZE	EDP. NO.	ENG. NO.	DIM. A REF.	DIM. B REF.
2	50-57-8902	70066-0351	(2.54) .100	(5.05) .199
3	50-57-8903	70066-0352	(5.08) .200	(7.59) .299
4	50-57-8904	70066-0353	(7.62) .300	(10.13) .399
5	50-57-8905	70066-0354	(10.16) .400	(12.67) .499
6	50-57-8906	70066-0355	(12.70) .500	(15.21) .599
7	50-57-8907	70066-0356	(15.24) .600	(17.75) .699
8	50-57-8908	70066-0357	(17.78) .700	(20.29) .799
9	50-57-8909	70066-0358	(20.32) .800	(22.83) .899
10	50-57-8910	70066-0359	(22.86) .900	(25.37) .999
11	NOT TOOLED	70066-0360	(25.40) 1.000	(27.91) 1.099
12	NOT TOOLED	70066-0361	(27.94) 1.100	(30.45) 1.199
13	NOT TOOLED	70066-0362	(30.48) 1.200	(32.99) 1.299
14	NOT TOOLED	70066-0363	(33.02) 1.300	(35.53) 1.399
15	NOT TOOLED	70066-0364	(35.56) 1.400	(38.07) 1.499
16	NOT TOOLED	70066-0365	(38.10) 1.500	(40.61) 1.599
17	NOT TOOLED	70066-0366	(40.64) 1.600	(43.15) 1.699
18	NOT TOOLED	70066-0367	(43.18) 1.700	(45.69) 1.799
19	NOT TOOLED	70066-0368	(45.72) 1.800	(48.23) 1.899
20	NOT TOOLED	70066-0369	(48.26) 1.900	(50.77) 1.999
21	NOT TOOLED	70066-0370	(50.80) 2.000	(53.31) 2.099
22	NOT TOOLED	70066-0371	(53.34) 2.100	(55.85) 2.199
23	NOT TOOLED	70066-0372	(55.88) 2.200	(58.39) 2.299
24	NOT TOOLED	70066-0373	(58.42) 2.300	(60.93) 2.399
25	NOT TOOLED	70066-0374	(60.96) 2.400	(63.47) 2.499

**OPTION "M"**

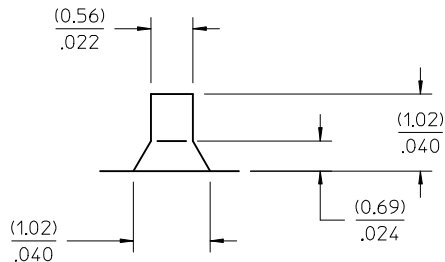

**DETAIL "F"**  
TYP.  
SCALE 20:1

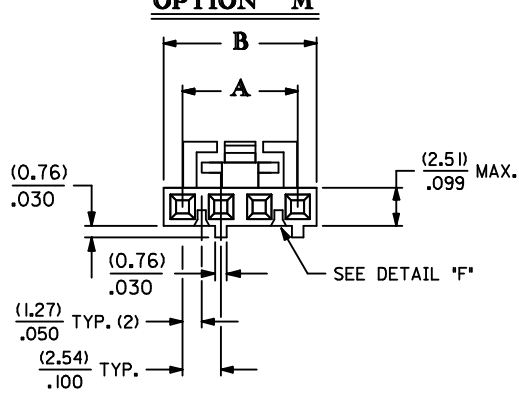
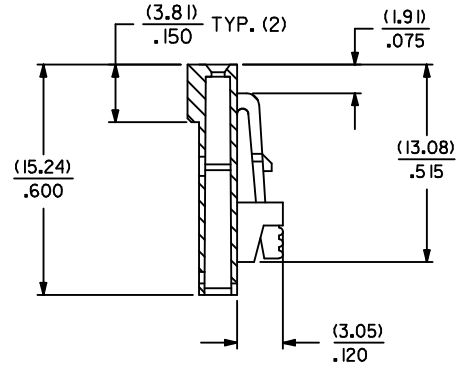
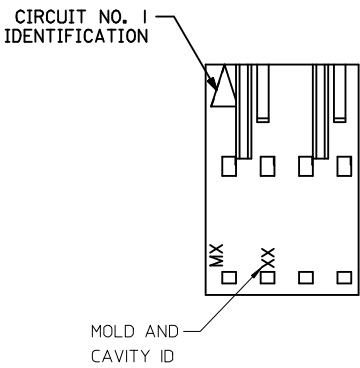

**SECTION C-C**

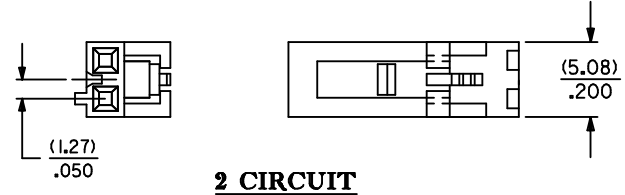
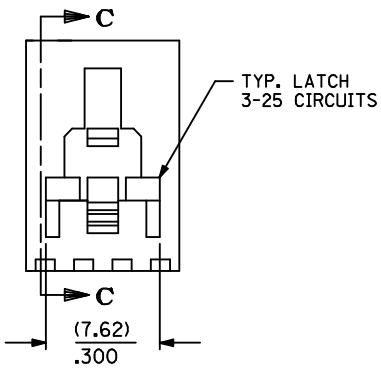

**2 CIRCUIT**

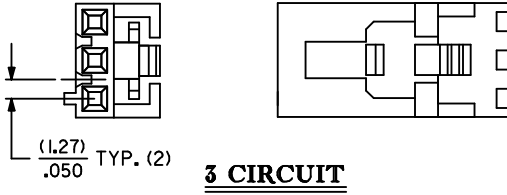

**3 CIRCUIT**

- NOTES:
1. MATERIAL GLASS FILLED POLYESTER; UL94V-0; COLOR: BLACK.
  2. HOUSING MAY BE USED WITH TERMINAL NUMBERS 70058, 71851, AND 70021.
  3. REFER TO CHART FOR AVAILABLE CIRCUIT SIZES.
  4. HOUSINGS TO BE USED WITH (0.64) .025 SQUARE OR ROUND PINS.
  5. REFER TO MOLEX PRODUCT SPECIFICATION(S): PS-70400, PS-70058, PS-71851, PS-70021, AND MOLEX APPLICATION SPECIFICATION SD5-70400.
  6. DIMENSIONS ARE SHOWN FOR REFERENCE ONLY.
  7. PACKAGE PER PK-70066-100.

LOCATE MOLD & CAVITY ID EC NO: UCP2014-4216 DRWNR:WHIPPLE 2014/04/11 CHKD:DMORGAN 2014/04/11 APPR:SMILLER 2014/04/28	QUALITY SYMBOLS	GENERAL TOLERANCES (UNLESS SPECIFIED)	DIMENSION STYLE	SCALE	DESIGN UNITS	THIRD ANGLE PROJECTION
	▽=0	mm INCH	MM/IN	4:1	INCH	
	▽=0	4 PLACES ± --- ± ---	DRAWN BY DATE			
	▽=0	3 PLACES ± --- ± .010	DMORGAN 2011/11/14			
		2 PLACES ± 0.25 ± .015	CHECKED BY DATE			
		1 PLACE ± 0.38 ± ---	SMR 1993/10/12			
		0 PLACE ± ±	APPROVED BY DATE			
		ANGULAR ±1/2°	SMILLER 2012/02/13			
		DRAFT WHERE APPLICABLE MUST REMAIN WITHIN DIMENSIONS	MATERIAL NO.	DOCUMENT NO.		
			SEE CHART	SD-70066-0351-0374		
			SIZE C			
			THIS DRAWING CONTAINS INFORMATION THAT IS PROPRIETARY TO MOLEX INCORPORATED AND SHOULD NOT BE USED WITHOUT WRITTEN PERMISSION			

HOUSING-CONNECTOR  
W/POLARIZATION SLOTS &  
RIBS (2.54) .100 GRID

**molex**

SHEET NO.  
1 OF 1