

TCK-072

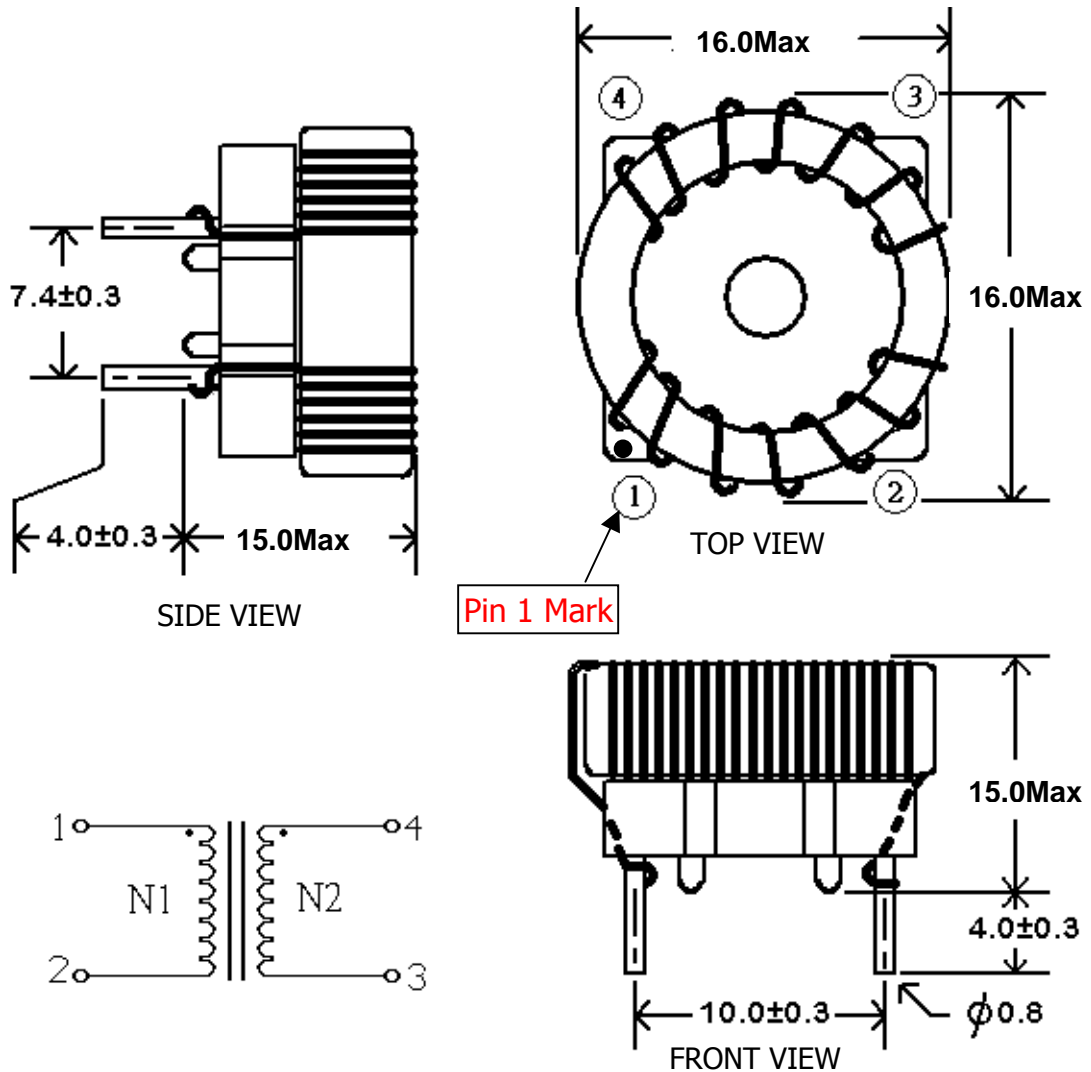

All dimensions in mm

SPECIFICATIONS

Inductance	Pin 1-2: $156 \mu\text{H} \pm 35\%$ Pin 3-4: $156 \mu\text{H} \pm 35\%$
	Test Condition: 100KHz/100mV Measurement Instrument: HP 4263B LCR Meter
Impedance	DCR(Max): 15 m Ω
	Measurement Instrument: HIOKI 3540 m Ω HITESTER
Rated Current	IDC(Max): 11.3A
	Measurement Instrument: Agilent 34401A Meter
Rated voltage	500Vdc
Operating temperature	-40°C ~ +105°C
Recommended Through Hole	$\phi 1.0$ mm