

## Standard Rectifier Module

<b>3~ Rectifier</b>	
$V_{RRM}$	= 1400 V
$I_{DAV}$	= 35 A
$I_{FSM}$	= 400 A

### 3~ Rectifier Bridge

Part number

VUO35-14N07

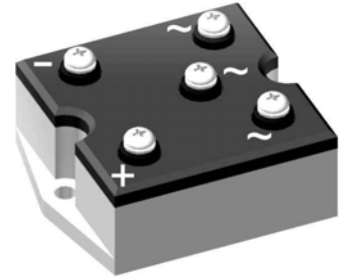

 E72873

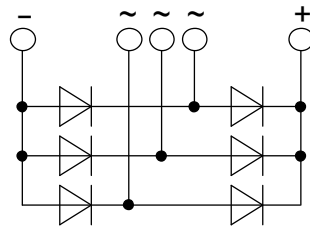

#### Features / Advantages:

- Package with DCB ceramic
- Improved temperature and power cycling
- Planar passivated chips
- Very low forward voltage drop
- Very low leakage current

#### Applications:

- Diode for main rectification
- For three phase bridge configurations
- Supplies for DC power equipment
- Input rectifiers for PWM inverter
- Battery DC power supplies
- Field supply for DC motors

#### Package: PWS-A

- Industry standard outline
- RoHS compliant
- Easy to mount with two screws
- Base plate: Aluminium internally DCB isolated
- Advanced power cycling

Rectifier				Ratings		
Symbol	Definition	Conditions	min.	typ.	max.	Unit
$V_{RSM}$	max. non-repetitive reverse blocking voltage	$T_{VJ} = 25^{\circ}C$			1500	V
$V_{RRM}$	max. repetitive reverse blocking voltage	$T_{VJ} = 25^{\circ}C$			1400	V
$I_R$	reverse current	$V_R = 1400 V$	$T_{VJ} = 25^{\circ}C$		40	$\mu A$
		$V_R = 1400 V$	$T_{VJ} = 150^{\circ}C$		1.5	mA
$V_F$	forward voltage drop	$I_F = 15 A$	$T_{VJ} = 25^{\circ}C$		1.10	V
					1.38	V
		$I_F = 45 A$	$T_{VJ} = 125^{\circ}C$		1.01	V
					1.38	V
$I_{DAV}$	bridge output current	$T_C = 85^{\circ}C$ rectangular $d = \frac{1}{3}$	$T_{VJ} = 150^{\circ}C$		35	A
$V_{FO}$	threshold voltage		$T_{VJ} = 150^{\circ}C$		0.80	V
$r_F$	slope resistance				12.9	m $\Omega$
$R_{thJC}$	thermal resistance junction to case				4.2	K/W
$R_{thCH}$	thermal resistance case to heatsink			0.6		K/W
$P_{tot}$	total power dissipation		$T_C = 25^{\circ}C$		29	W
$I_{FSM}$	max. forward surge current	$t = 10 \text{ ms; (50 Hz), sine}$ $t = 8,3 \text{ ms; (60 Hz), sine}$	$T_{VJ} = 45^{\circ}C$ $V_R = 0 V$		400	A
					430	A
		$t = 10 \text{ ms; (50 Hz), sine}$ $t = 8,3 \text{ ms; (60 Hz), sine}$	$T_{VJ} = 150^{\circ}C$ $V_R = 0 V$		340	A
					365	A
$I^2t$	value for fusing	$t = 10 \text{ ms; (50 Hz), sine}$ $t = 8,3 \text{ ms; (60 Hz), sine}$	$T_{VJ} = 45^{\circ}C$ $V_R = 0 V$		800	A <sup>2</sup> s
					770	A <sup>2</sup> s
		$t = 10 \text{ ms; (50 Hz), sine}$ $t = 8,3 \text{ ms; (60 Hz), sine}$	$T_{VJ} = 150^{\circ}C$ $V_R = 0 V$		580	A <sup>2</sup> s
					555	A <sup>2</sup> s
$C_J$	junction capacitance	$V_R = 400 V; f = 1 \text{ MHz}$	$T_{VJ} = 25^{\circ}C$		10	pF

Package PWS-A			Ratings			
Symbol	Definition	Conditions	min.	typ.	max.	Unit
$I_{RMS}$	RMS current	per terminal			100	A
$T_{stg}$	storage temperature		-40		125	°C
$T_{VJ}$	virtual junction temperature		-40		150	°C
<b>Weight</b>				100		g
$M_D$	mounting torque		1.25		1.75	Nm
$M_T$	terminal torque		1.25		1.75	Nm
$d_{Spp/App}$	creepage distance on surface   striking distance through air	terminal to terminal	6.5			mm
$d_{Spt/Apb}$		terminal to backside	8.5			mm
$V_{ISOL}$	isolation voltage	t = 1 second	3000			V
		t = 1 minute	2500			V

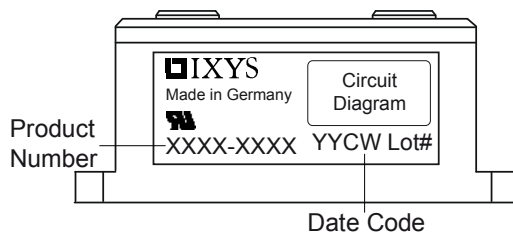

Ordering	Part Number	Marking on Product	Delivery Mode	Quantity	Code No.
Standard	VUO35-14NO7	VUO35-14NO7	Box	20	456640

### Equivalent Circuits for Simulation

\* on die level

$T_{VJ} = 150\text{ °C}$

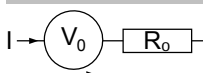

Rectifier

$V_{0\ max}$	threshold voltage	0.8	V
$R_{0\ max}$	slope resistance *	11.7	mΩ

**Outlines PWS-A**

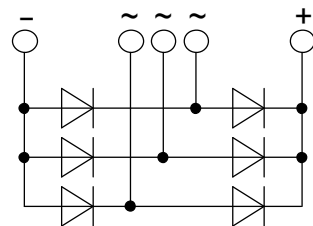
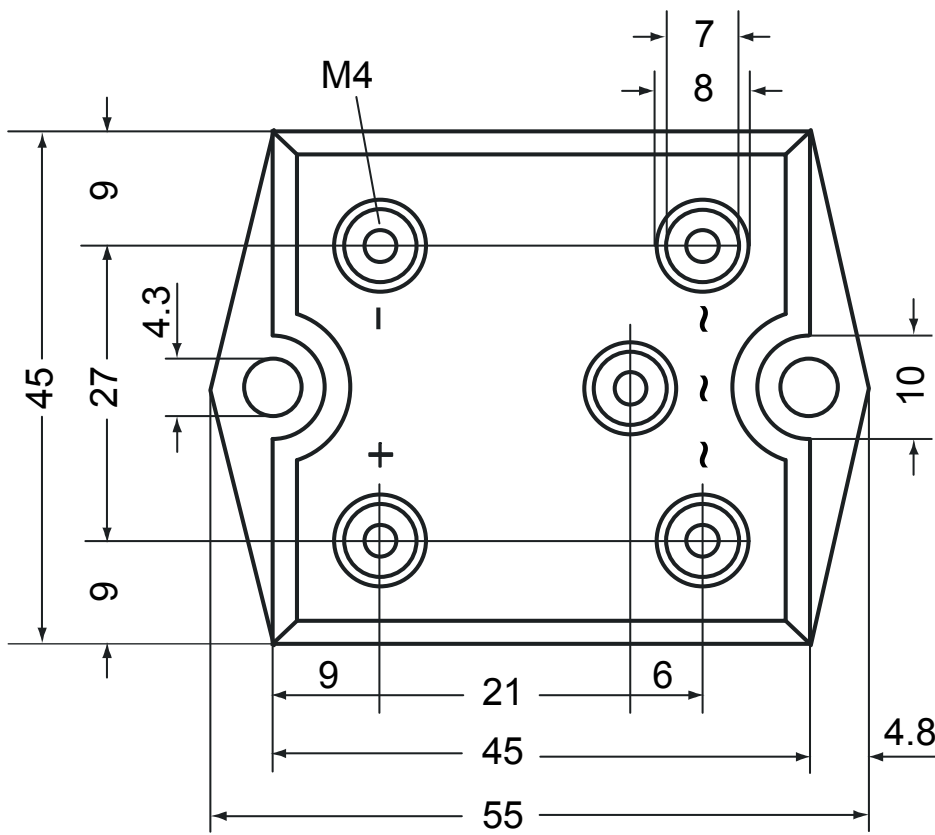
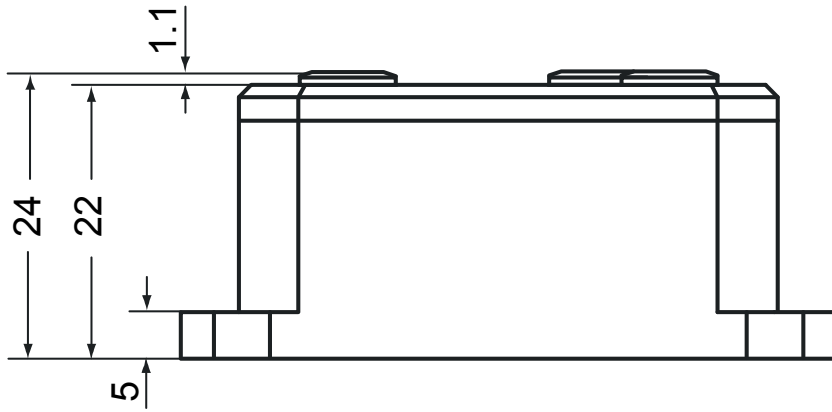

**Rectifier**

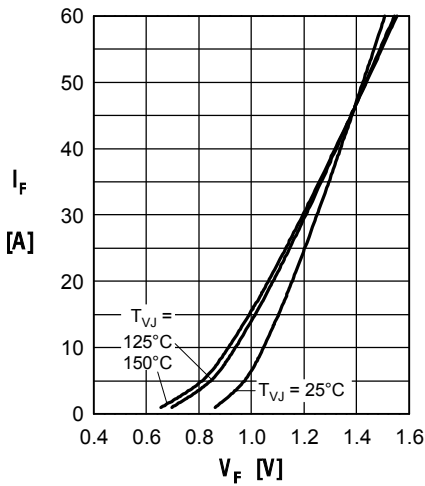

Fig. 1 Forward current vs. voltage drop per diode

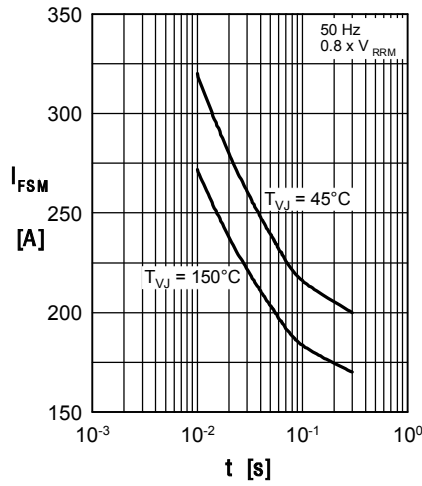

Fig. 2 Surge overload current vs. time per diode

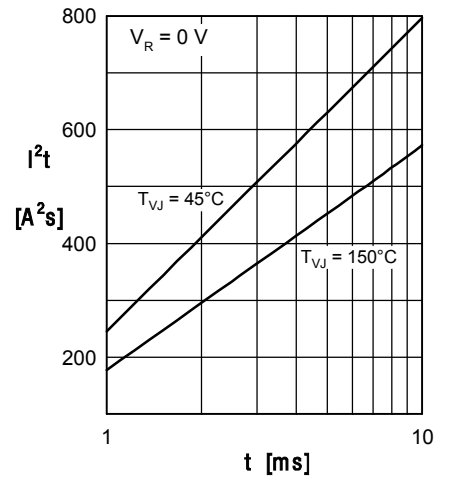

Fig. 3  $I^2t$  vs. time per diode

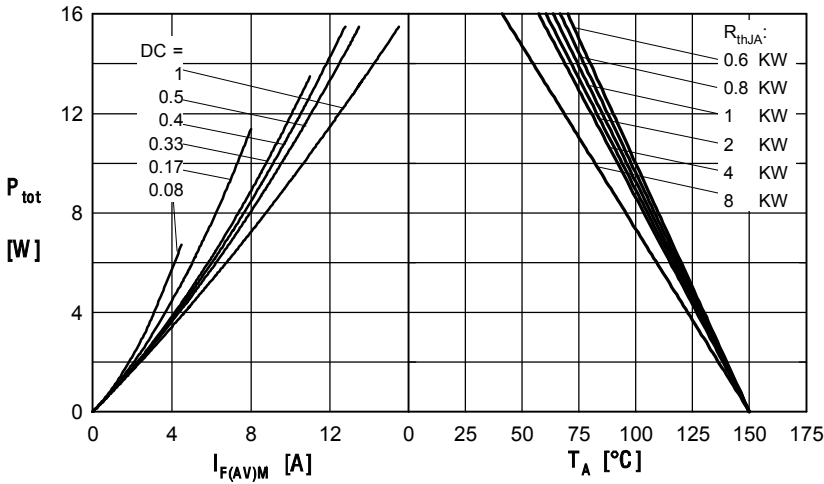

Fig. 4 Power dissipation vs. forward current and ambient temperature per diode

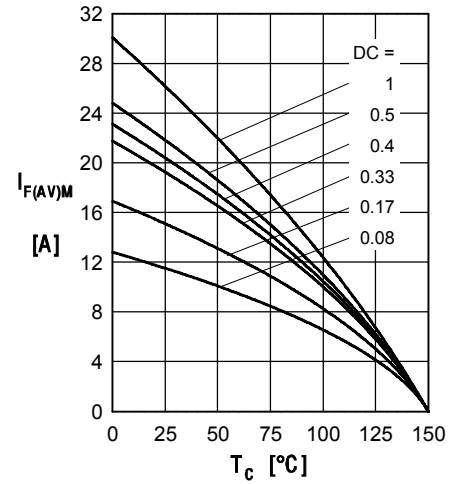

Fig. 5 Max. forward current vs. case temperature per diode

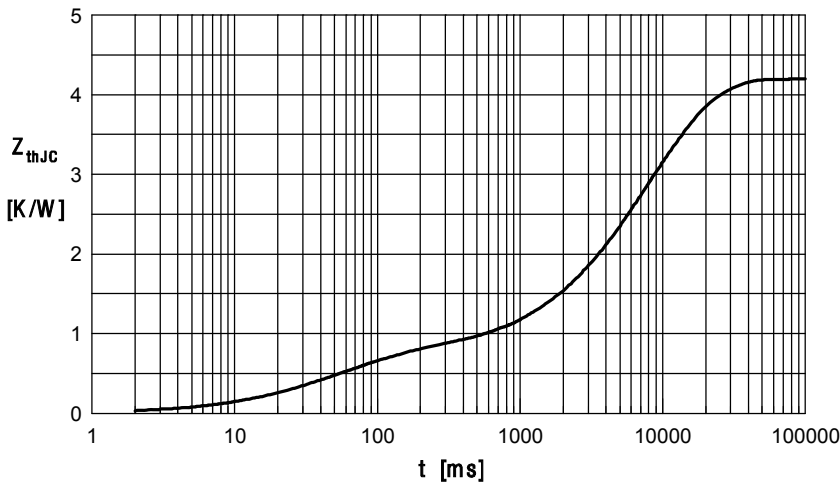

Fig. 6 Transient thermal impedance junction to case vs. time per diode

Constants for  $Z_{thJC}$  calculation:

i	$R_{th}$ (K/W)	$t_i$ (s)
1	0.194	0.024
2	0.556	0.070
3	0.450	3.250
4	3.000	9.300