

# SPECIFICATION

- Part No.** : **PA.11**
- Product Name** : 2.4GHz Band Dielectric Ceramic PIFA  
SMT Antenna for Bluetooth/WLAN/Zigbee  
Applications
- Description** : 2400-2484Mhz, 1.5dBi Peak Gain  
Size: 10mm\*4mm\*3mm  
Designed for the top right hand corner edge of  
the Component side of the board (bottom left  
corner edge)  
SMT Mount  
RoHS Compliant

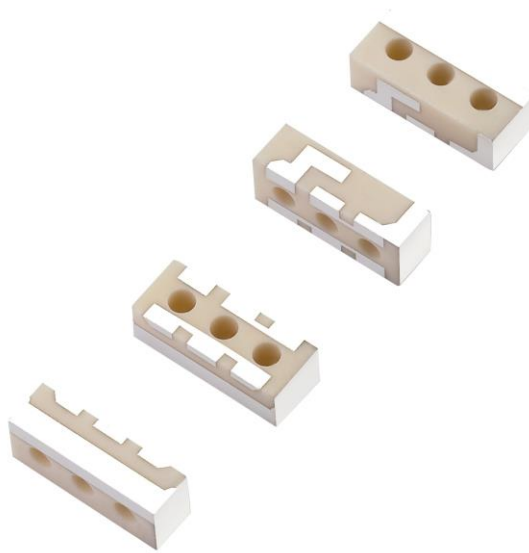

## 1. Introduction

This specification covers the Dielectric PIFA Antenna for 2400-2484MHz, covering such applications as Wi-Fi, Bluetooth and Zigbee. A ceramic dielectric

PIFA antenna offers smallest footprint, superior gain characteristics and improved isolation over traditional PCB based antennas. This antenna has been developed for the top right hand corner edge of the component side of the Board (bottom left corner edge), the antenna has to be positioned on a non-ground (copper/metal free) area with the feed-point matched direct to the module. Please refer to Recommended Foot print Diagram (8.0 Page 13.).

Many module manufacturers specify peak gain limits for any antennas that are to be connected to that module. Those peak gain limits are based on free-space conditions. In practice, the peak gain of an antenna tested in free-space can degrade by at least 1 or 2dBi when put inside a device. So ideally you should go for a slightly higher peak gain antenna than mentioned on the module specification to compensate for this effect, giving you better performance.

Upon testing of any of our antennas with your device and a selection of appropriate layout, integration technique, or cable, Taoglas can make sure any of our antennas' peak gain will be below the peak gain limits. Taoglas can then issue a specification and/or report for the selected antenna in your device that will clearly show it complying with the peak gain limits, so you can be assured you are meeting regulatory requirements for that module.

For example, a module manufacturer may state that the antenna must have less than 2dBi peak gain, but you don't need to select an embedded antenna that has a peak gain of less than 2dBi in free-space. This will give you a less optimized solution. It is better to go for a slightly higher free-space peak gain of 3dBi or more if available. Once that antenna gets integrated into your device, performance will degrade below this 2dBi

peak gain due to the effects of GND plane, surrounding components, and device housing. If you want to be absolutely sure, contact Taoglas and we will test. Choosing a Taoglas antenna with a higher peak gain than what is specified by the module manufacturer and enlisting our help will ensure you are getting the best performance possible without exceeding the peak gain limits.

## 2. Electrical Specifications

The antenna has the electrical characteristics given in Table 1 under the Taoglas standard installation conditions as shown in the Evaluation Board. figure.

No.	Parameter	Specification
1	Working Frequency	2400MHz ~ 2484MHz
2	Dimensions	10*4*3mm
3	Peak Gain	1.5 dBi max
4	Polarization	Linear
5	Impedance	50 Ω
6	VSWR	2.0 max
7	Operating Temperature	-40~+85°C
8	Termination	Ag(Environmentally Friendly Lead-Free)

\* Data is measured on Taoglas Standard Reference PCB

### 3. S11 Response Curve

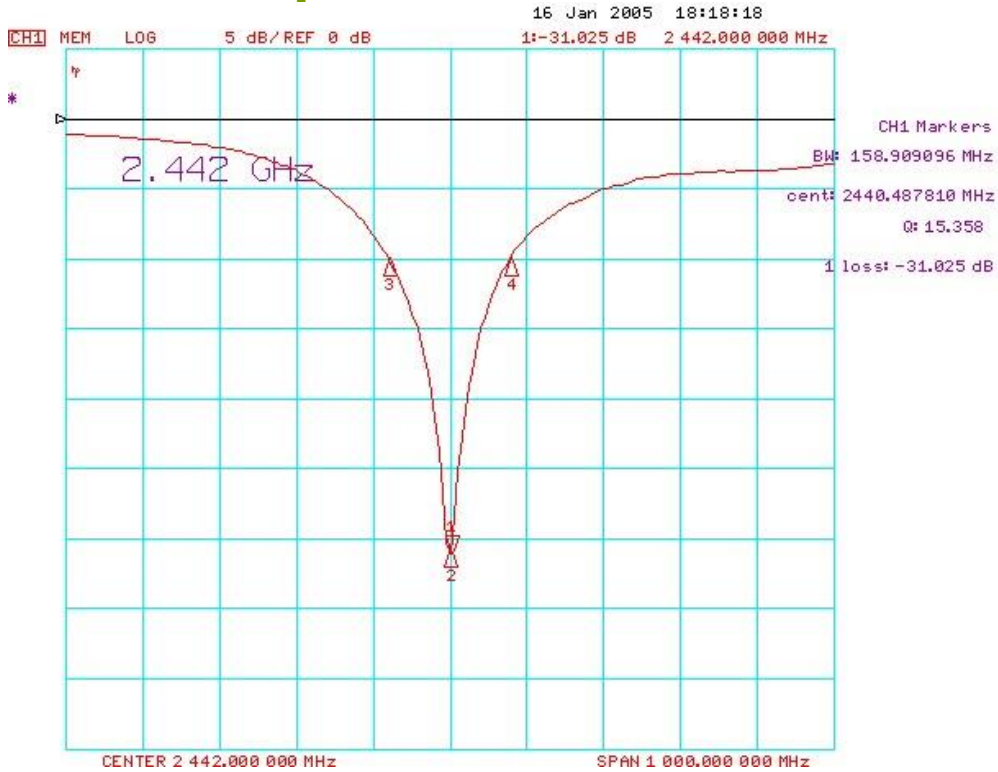

- \* Gain is measured on test PCB (40\*80\*0.8)
- \* Ant position: Right side, top corner edge, horizontal

### 4. Test Position

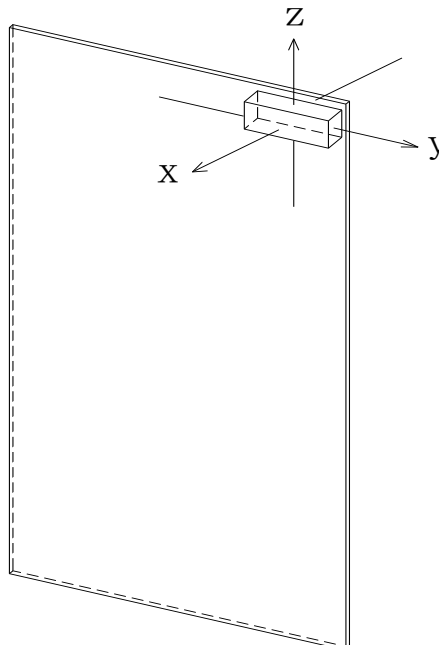

## 5. Summary of Test Results

### 5.1 Gain & Efficiency

	Frequency (GHz)	Peak Gain(dBi)	Efficiency (%)
1	2.400	2.78	80.64
2	2.442	31.2	85.65
3	2.450	3.27	86.50
4	2.4835	2.76	75.91
5	2.500	2.34	68.07

### 5.2 Power Average Gain

	Frequency (GHz)	Plane	Average Gain (dBi)
1	2.400	XY plane	-1.622
		YZ plane	-1.324
		XZ plane	-0.561
2	2.442	XY plane	-2.464
		YZ plane	-0.859
		XZ plane	-0.312
3	2.450	XY plane	-1.424
		YZ plane	-0.950
		XZ plane	-0.224
4	2.4835	XY plane	-2.949
		YZ plane	-1.548
		XZ plane	-0.784
5	2.500	XY plane	-2.444
		YZ plane	-2.084
		XZ plane	-1.258

## 6. Antenna Pattern – Wi-Fi & Bluetooth

Frequency: 2.400 GHz

Far-field Power Distribution on X-Z Plane(E-Plane of L3 Pol Sense)  
Gain=2.78 dBi; Total Radiating Efficiency: 80.64% @2.40000 GHz

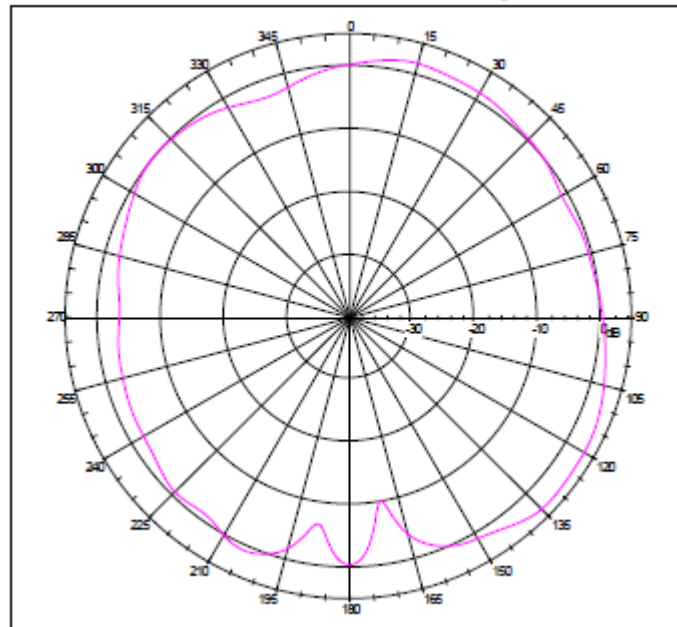

Far-field Power Distribution on Y-Z Plane(H-Plane of L3 Pol Sense)  
Gain=2.78 dBi; Total Radiating Efficiency: 80.64% @2.40000 GHz

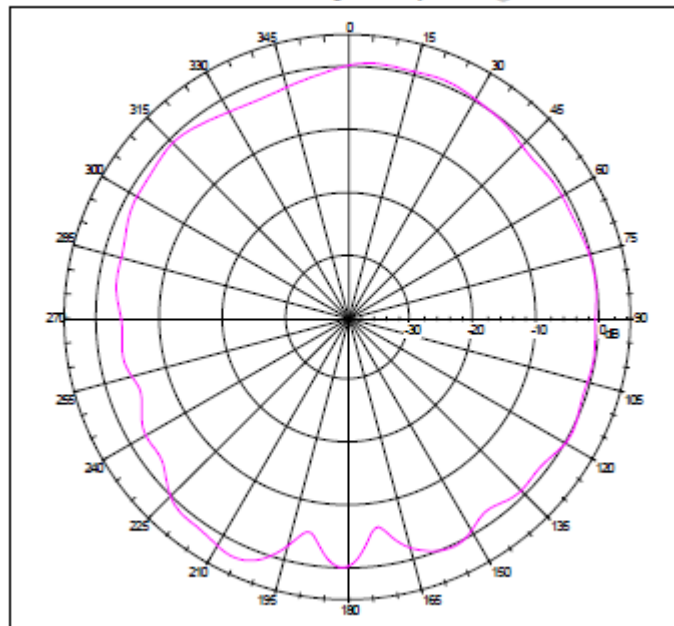

Far-field Power Distribution on X-Y Plane  
 Gain=2.78 dBi; Total Radiating Efficiency: 80.64% @2.40000 GHz

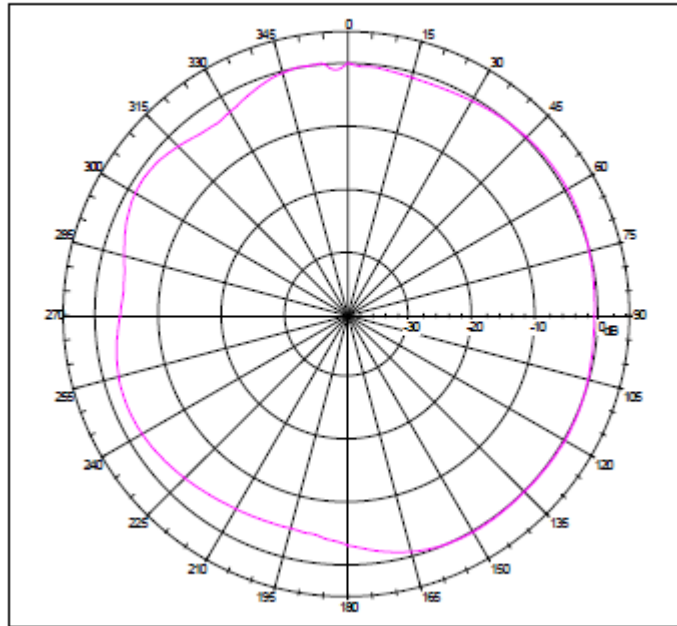

**Frequency: 2.442 GHz**

Far-field Power Distribution on X-Z Plane(E-Plane of L3 Pol Sense)  
 Gain=3.12 dBi; Total Radiating Efficiency: 85.65% @2.44200 GHz

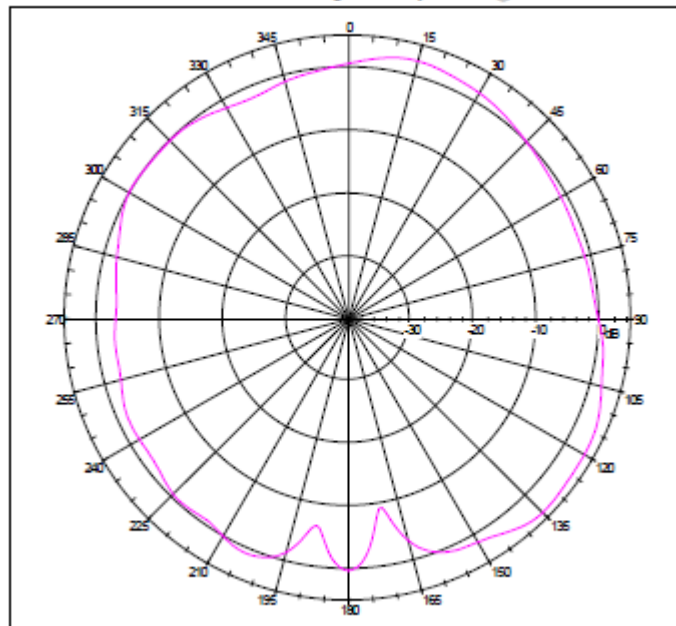



Far-field Power Distribution on Y-Z Plane(H-Plane of L3 Pol Sense)  
Gain=3.12 dBi; Total Radiating Efficiency: 85.65% @2.44200 GHz

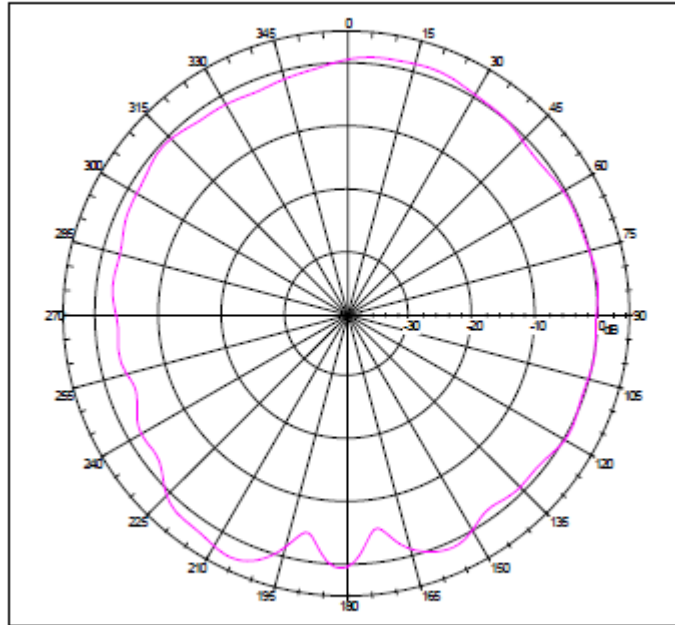

Far-field Power Distribution on X-Y Plane  
Gain=3.12 dBi; Total Radiating Efficiency: 85.65% @2.44200 GHz

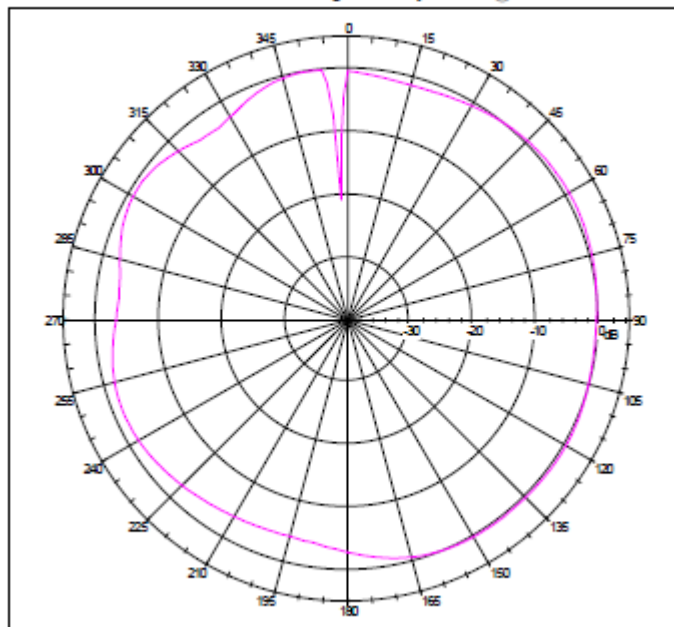





**Frequency: 2.450 GHz**

Far-field Power Distribution on X-Z Plane(E-Plane of L3 Pol Sense)  
Gain=3.27 dBi; Total Radiating Efficiency: 86.20% @2.45000 GHz

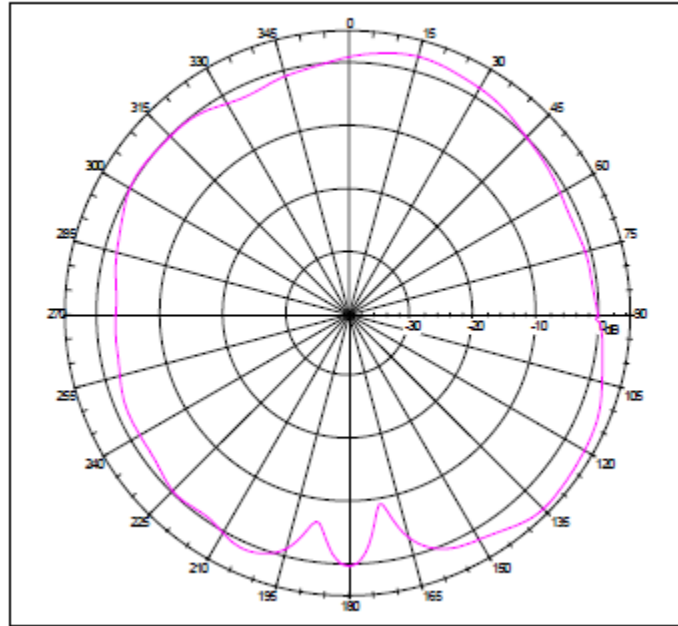

Far-field Power Distribution on Y-Z Plane(H-Plane of L3 Pol Sense)  
Gain=3.27 dBi; Total Radiating Efficiency: 86.20% @2.45000 GHz

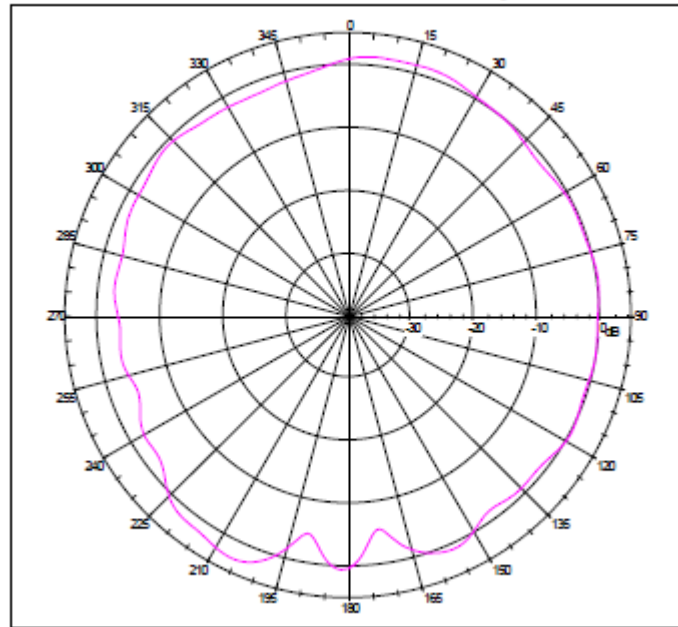



Far-field Power Distribution on X-Y Plane  
Gain=3.27 dBi; Total Radiating Efficiency: 86.20% @2.45000 GHz

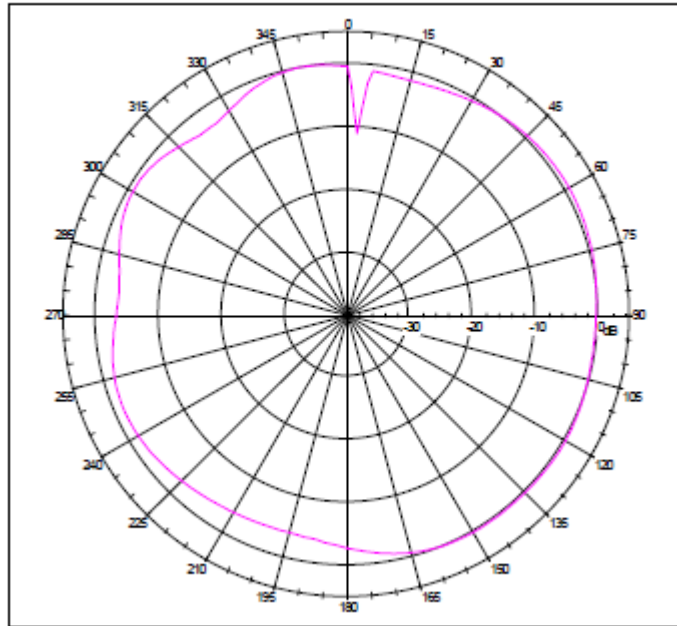

**Frequency: 2.4835 GHz**

Far-field Power Distribution on X-Z Plane(E-Plane of L3 Pol Sense)  
Gain=2.76 dBi; Total Radiating Efficiency: 75.91% @2.48350 GHz

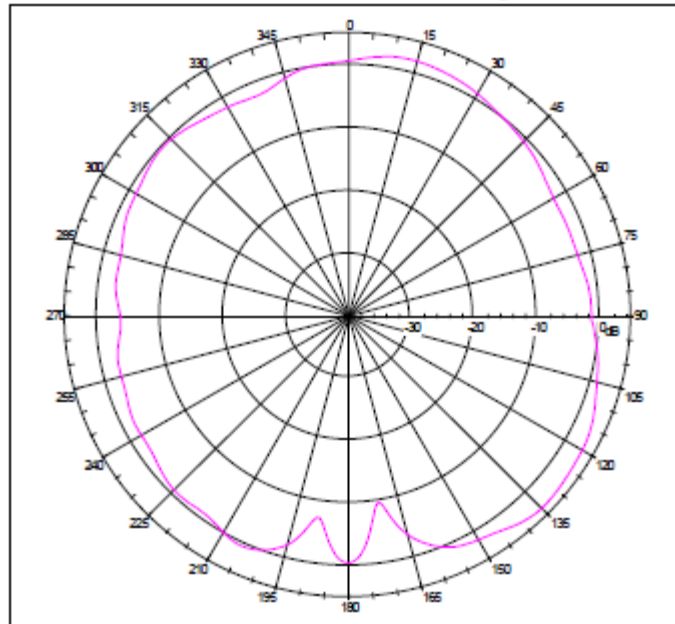



**Far-field Power Distribution on Y-Z Plane(H-Plane of L3 Pol Sense)**  
Gain=2.76 dBi; Total Radiating Efficiency: 75.91% @2.48350 GHz

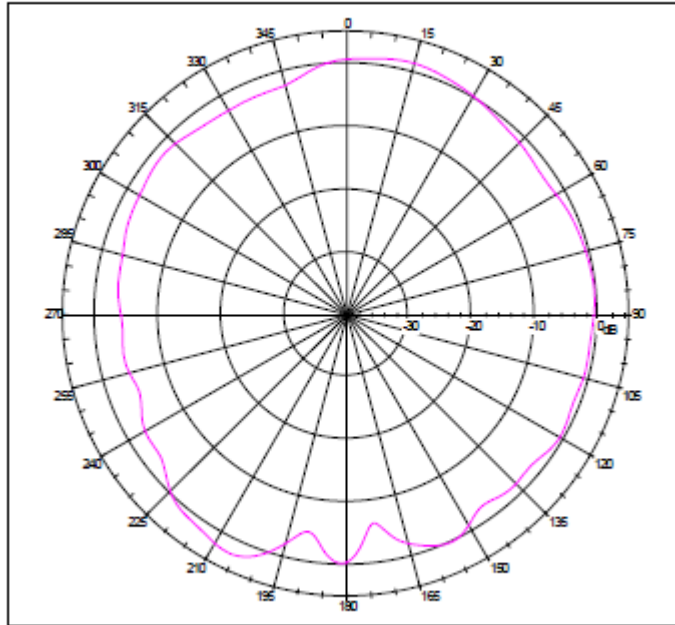

**Far-field Power Distribution on X-Y Plane**  
Gain=2.76 dBi; Total Radiating Efficiency: 75.91% @2.48350 GHz

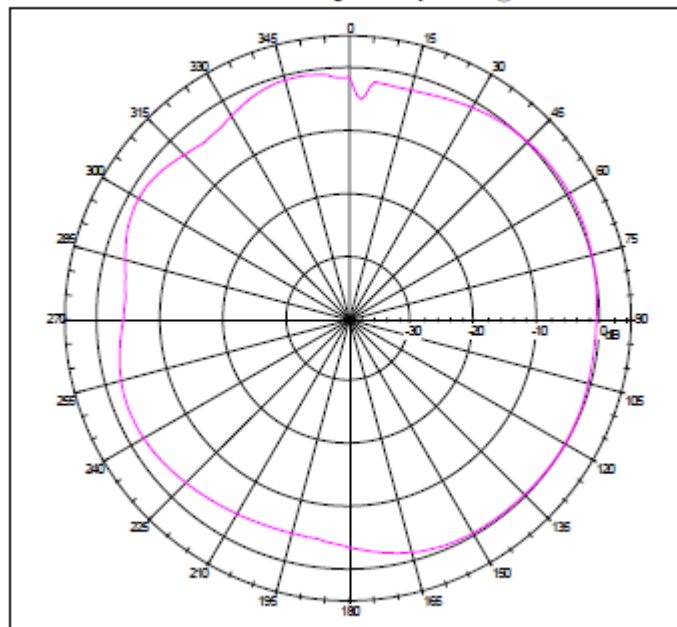



**Frequency: 2.500 GHz**

Far-field Power Distribution on X-Z Plane(E-Plane of L3 Pol Sense)  
Gain=2.34 dBi; Total Radiating Efficiency: 68.07% @2.50000 GHz

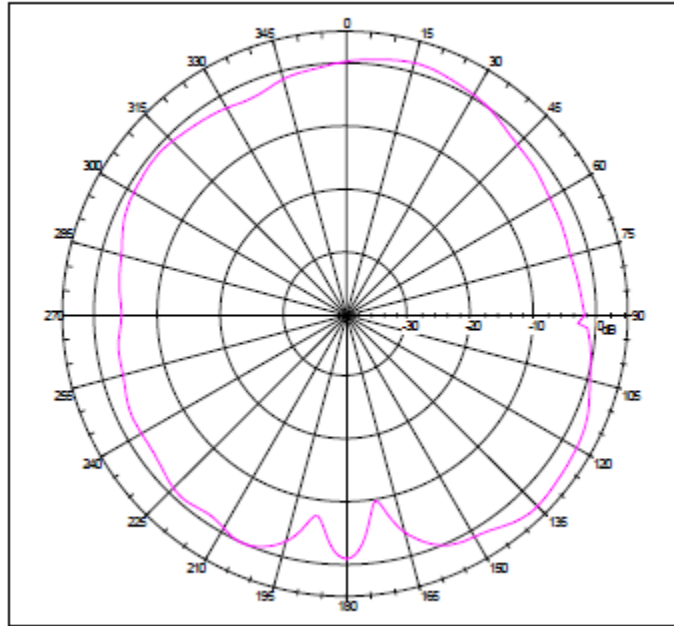

Far-field Power Distribution on Y-Z Plane(H-Plane of L3 Pol Sense)  
Gain=2.34 dBi; Total Radiating Efficiency: 68.07% @2.50000 GHz

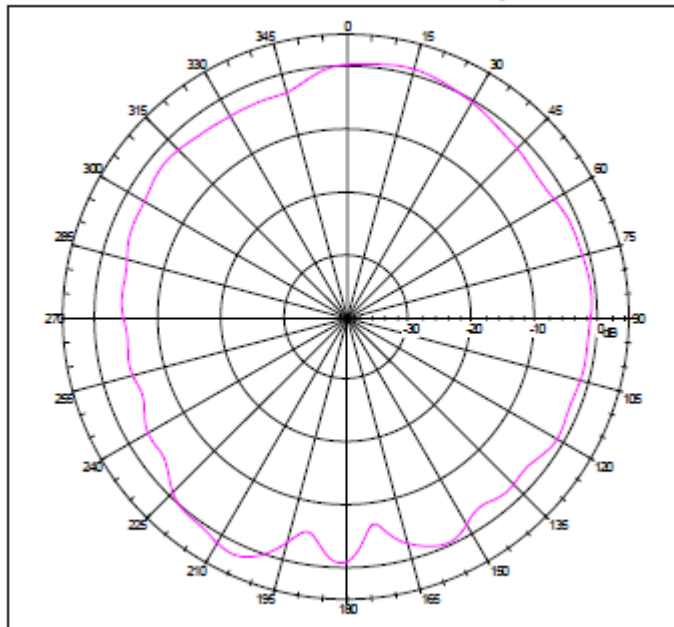

Far-field Power Distribution on X-Y Plane  
Gain=2.34 dBi; Total Radiating Efficiency: 68.07% @2.50000 GHz

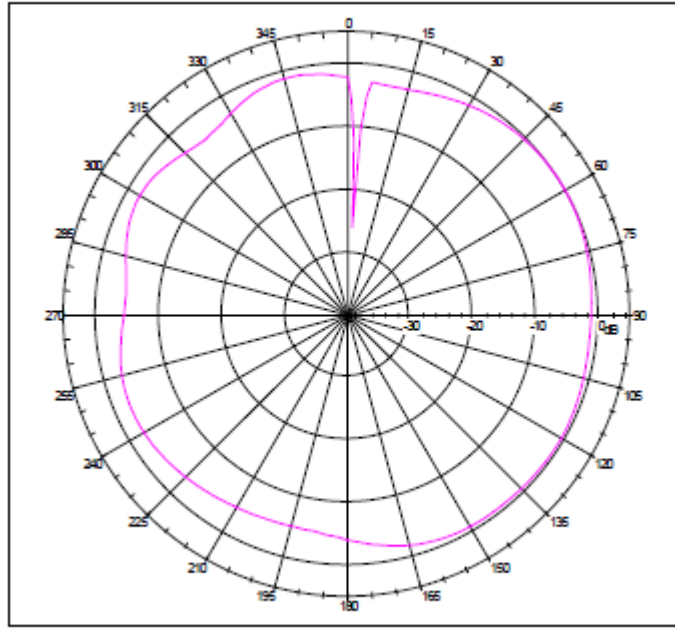

# 7. Drawing

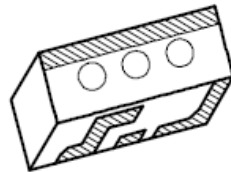

3D View

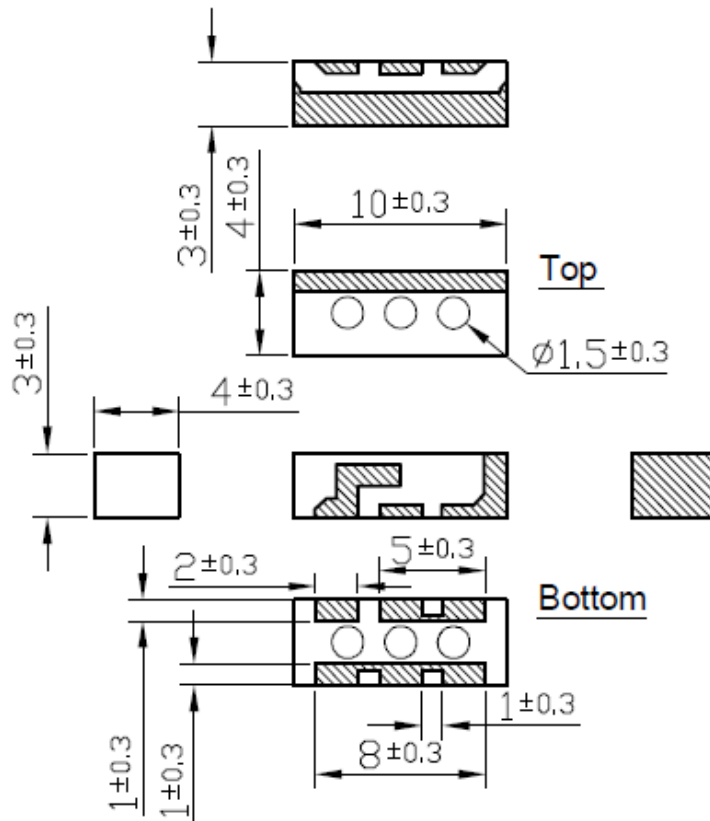

- Note:
- 1. Silver 
  - 2. Copper 
  - 3. Solder Area 
  - 4. Ground Clearance Area 

## 8. Recommended foot print for Evaluation Board

Footprint  
0.8t PCB

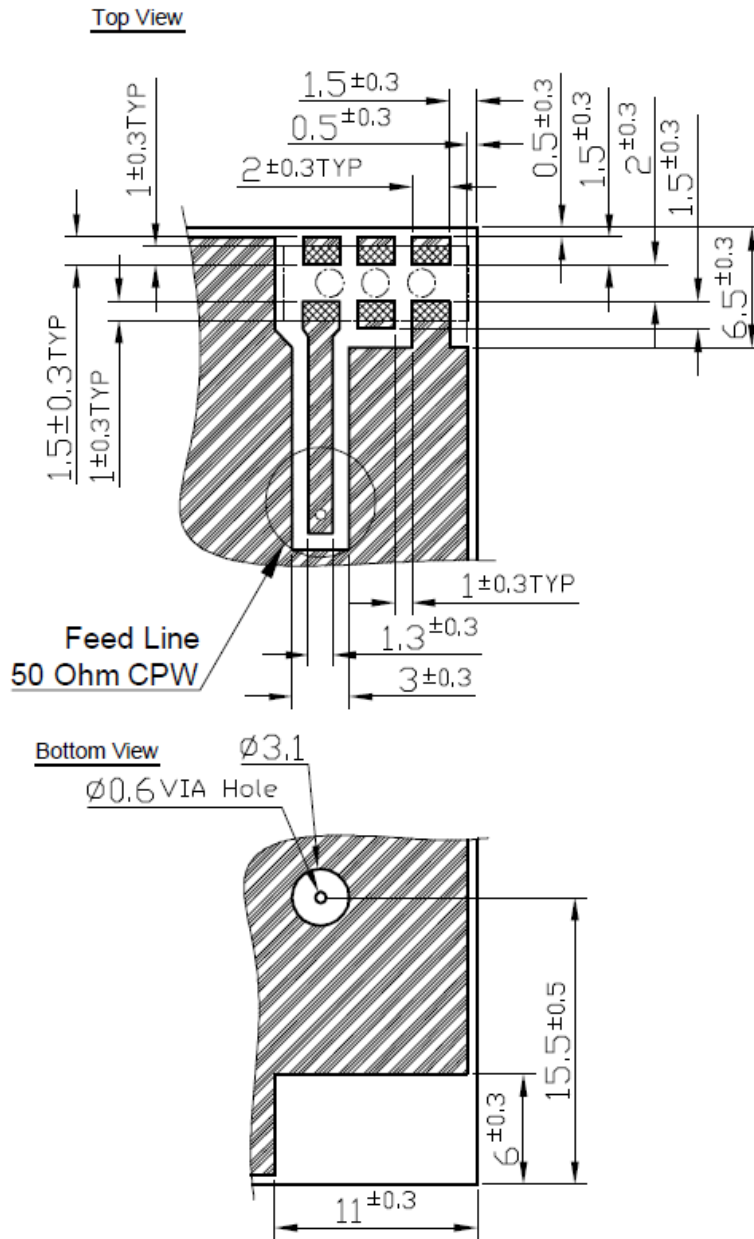

## 9. Packaging

1000 pcs PA.11 reel  
 Dimensions - 330\*30mm  
 Weight - 1.1kg

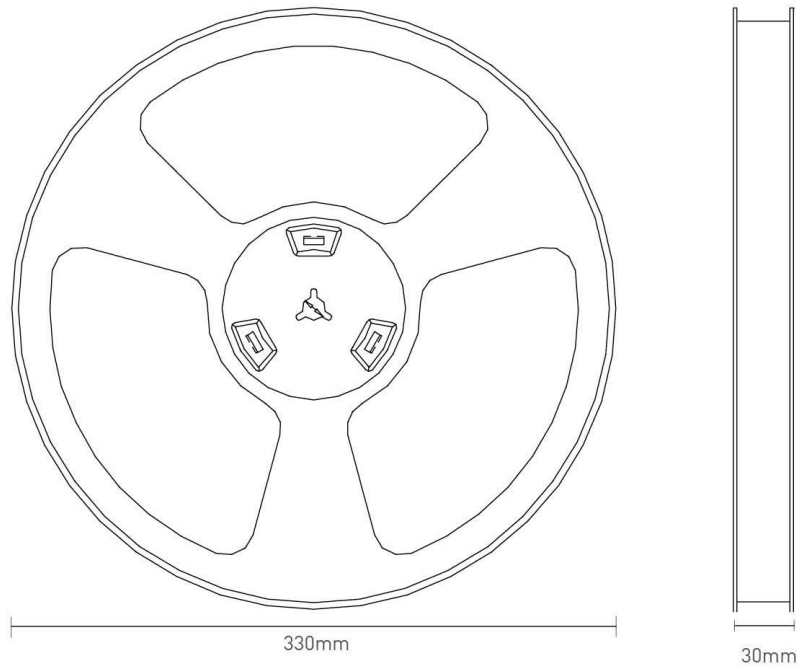

No.	Index	Spec. (mm)
1	A	4.6
2	B	10.6
3	P1	12
4	W	24
5	F	8.5
6	T	3.5
7	D	1.5

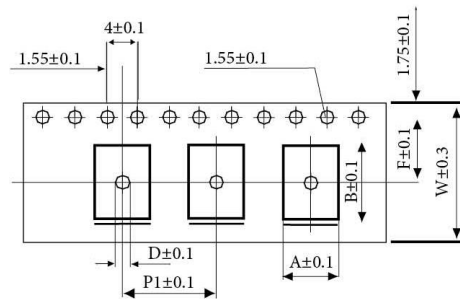



1000 pcs PA.11  
1 reel in small inner box  
Dimensions - 350\*350\*70  
Weight - 1.4Kg

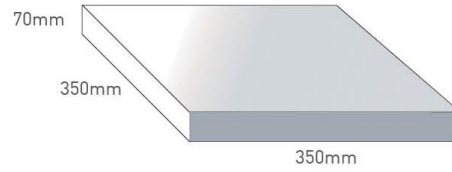

5 boxes / 5000 pcs in one carton  
Carton Dimensions - 370\*360\*275mm  
Weight - 7Kg

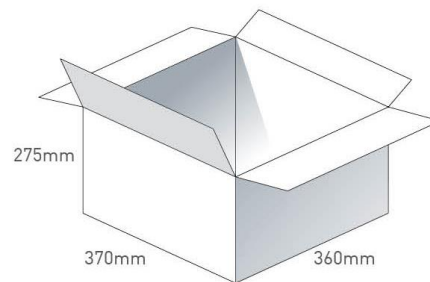

Pallet Dimensions 1110\*720\*1380mm  
24 Cartons per Pallet  
6 Cartons per layer  
4 Layers

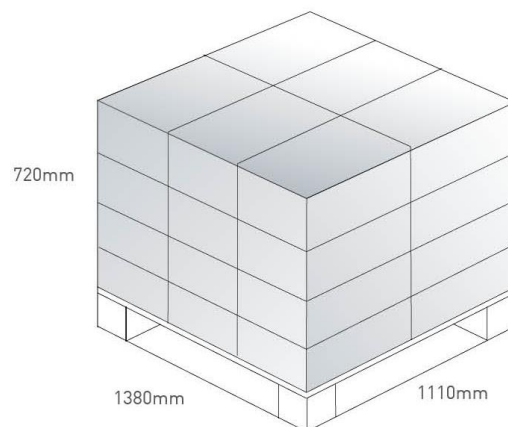

## 10. Recommended Reflow Temperature Profile

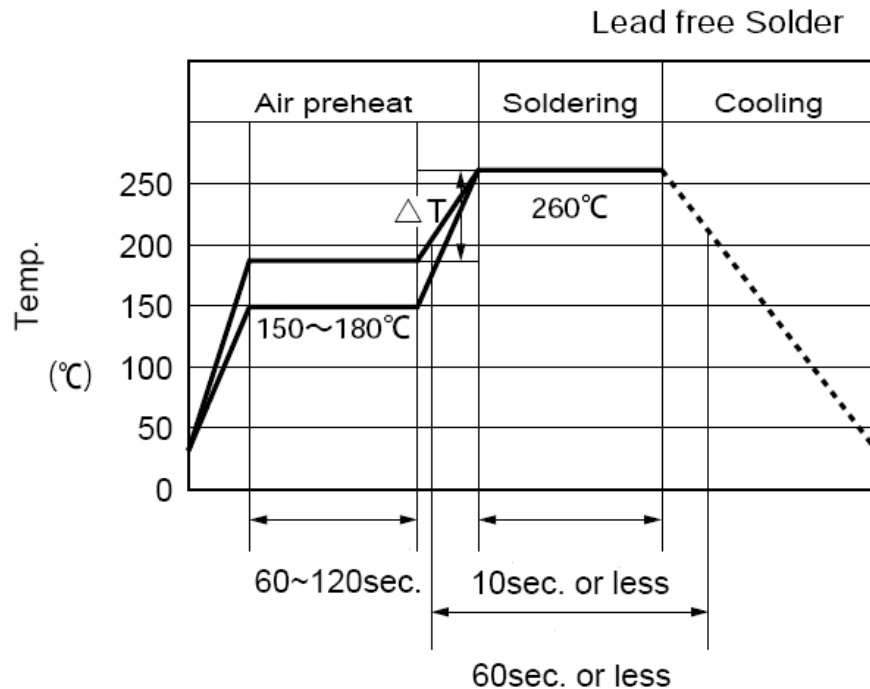

1. Time shown in the above figures is measured from the point when chip surface reaches temperature.
2. Temperature difference in high temperature part should be within 110°C.
3. After soldering, do not force cool, allow the parts to cool gradually.

\*General attention to soldering:

- High soldering temperatures and long soldering times can cause leaching of the termination, decrease in adherence strength, and the change of characteristic may occur.
- For soldering, please refer to the soldering curves above. However, please keep exposure to temperatures exceeding 200°C to under 50 seconds.
- Please use a mild flux (containing less than 0.2wt% Cl). Also, if the flux is water soluble, be sure to wash thoroughly to remove any residue from the underside of components that could affect resistance.



#### Cleaning:

When using ultrasonic cleaning, the board may resonate if the output power is too high. Since this vibration can cause cracking or a decrease in the adherence of the termination, we recommend that you use the conditions below.

Frequency: 40kHz

Output Power: 20W/liter

Cleaning Time: 5 minutes max