



WTL16P-34161120A00

W16

SMALL PHOTOELECTRIC SENSORS

SICK
Sensor Intelligence.



Illustration may differ



Ordering information

Type	Part no.
WTL16P-34161120A00	1218945

Other models and accessories → www.sick.com/W16

Detailed technical data

Features

Sensor/ detection principle	Photoelectric proximity sensor, LineSpot technology, Background suppression
Dimensions (W x H x D)	20 mm x 55.7 mm x 42 mm
Housing design (light emission)	Rectangular
Sensing range max.	10 mm ... 500 mm ¹⁾
Type of light	Visible red light
Light source	PinPoint LED ²⁾
Light spot size (distance)	3 mm x 30 mm (200 mm)
Wave length	635 nm
Adjustment	BluePilot: Teach-Turn adjustment with sensing range indicator IO-Link
Pin 2 configuration	External input, Teach-in, switching signal
Special applications	Detecting perforated objects
Special features	Line-shaped light spot

¹⁾ Object with 90 % reflectance (referred to standard white, DIN 5033).

²⁾ Average service life: 100,000 h at T_J = +25 °C.

Mechanics/electronics

Supply voltage	10 V DC ... 30 V DC ¹⁾
Ripple	$\leq 5 V_{pp}$
Power consumption	30 mA ²⁾ 50 mA ³⁾
Switching output	PUSH/PULL PNP NPN
Output function	Factory setting: Pin 2 (MF): NPN normally open (light switching), PNP normally closed (dark switching), Pin 4 (QL1/C): NPN normally closed (dark switching), PNP normally open (light switching), IO-Link
Switching mode	Light/dark switching
Signal voltage PNP HIGH/LOW	Approx. $V_S - 2.5 V / 0 V$
Signal voltage NPN HIGH/LOW	Approx. $V_S / < 2.5 V$
Output current I_{max}	$\leq 100 mA$
Response time	$\leq 500 \mu s$ ⁴⁾
Switching frequency	1,000 Hz ⁵⁾
Connection type	Cable with M12 male connector, 4-pin, 270 mm ⁶⁾
Cable material	PVC
Circuit protection	A ⁷⁾ B ⁸⁾ C ⁹⁾ D ¹⁰⁾
Protection class	III
Weight	70 g
IO-Link	✓
Housing material	Plastic, VISTAL®
Optics material	Plastic, PMMA
Enclosure rating	IP66 IP67
Ambient operating temperature	-40 °C ... +60 °C
Ambient storage temperature	-40 °C ... +75 °C
UL File No.	NRKH.E181493 & NRKH7.E181493

¹⁾ Limit values.

²⁾ 16 V DC ... 30 V DC, without load.

³⁾ 10 V DC ... 16 V DC, without load.

⁴⁾ Signal transit time with resistive load in switching mode. Different values possible in COM2 mode.

⁵⁾ With light/dark ratio 1:1 in switching mode. Different values possible in IO-Link mode.

⁶⁾ Do not bend below 0 °C.

⁷⁾ A = V_S connections reverse-polarity protected.

⁸⁾ B = inputs and output reverse-polarity protected.

⁹⁾ C = interference suppression.

¹⁰⁾ D = outputs overcurrent and short-circuit protected.

Classifications

ECl@ss 5.0	27270904
ECl@ss 5.1.4	27270904

ECl@ss 6.0	27270904
ECl@ss 6.2	27270904
ECl@ss 7.0	27270904
ECl@ss 8.0	27270904
ECl@ss 8.1	27270904
ECl@ss 9.0	27270904
ETIM 5.0	EC002719
ETIM 6.0	EC002719
UNSPSC 16.0901	39121528

Smart Task

Smart Task name	Base logics
Logic function	Direct AND OR Window Hysteresis
Timer function	Deactivated On delay Off delay ON and OFF delay Impulse (one shot)
Inverter	Yes
Switching frequency	SIO Direct: 1000 Hz ¹⁾ SIO Logic: 800 Hz ²⁾ IOL: 650 Hz ³⁾
Response time	SIO Direct: 500 µs ¹⁾ SIO Logic: 600 µs ²⁾ IOL: 750 µs ³⁾
Repeatability	SIO Direct: 150 µs ¹⁾ SIO Logic: 300 µs ²⁾ IOL: 400 µs ³⁾
Switching signal Q_{L1}	Switching output
Switching signal Q_{L2}	Switching output

¹⁾ SIO Direct: sensor operation in standard I/O mode without IO-Link communication and without using internal sensor logic or time parameters (set to "direct"/"deactivated").

²⁾ SIO Logic: Sensor operation in standard I/O mode without IO-Link communication. Sensor-internal logic or timing parameters plus Automation Functions used.

³⁾ IOL: Sensor operation with full IO-Link communication and usage of logic, timing and Automation Function parameters.

Communication interface

Communication interface	IO-Link V1.1
Communication Interface detail	COM2 (38,4 kBaud)
Cycle time	2.3 ms
Process data length	16 Bit
Process data structure	Bit 0 = switching signal Q _{L1} Bit 1 = switching signal Q _{L2} Bit 2 ... 15 = empty
VendorID	26
DeviceID HEX	0x800168

DeviceID DEZ

8388968

Connection diagram

Cd-390

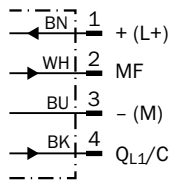

Characteristic curve

WTL16P-xxxxx1xx

Minimum distance in mm (y) between the set sensing range and background (white, 90%)

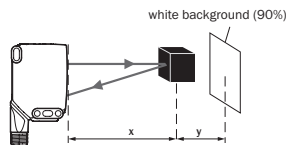
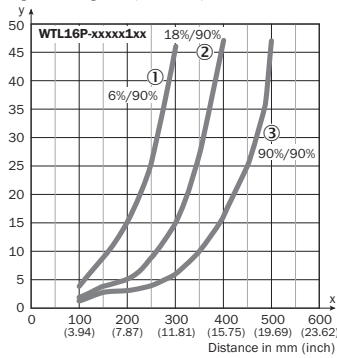

Example:
Sensing range on black, 6%,
x = 200 mm, y = 15 mm

- ① Sensing range on black, 6% remission
- ② Sensing range on gray, 18% remission
- ③ Sensing range on white, 90% remission

Light spot size

WTL16P-xxxx1xx

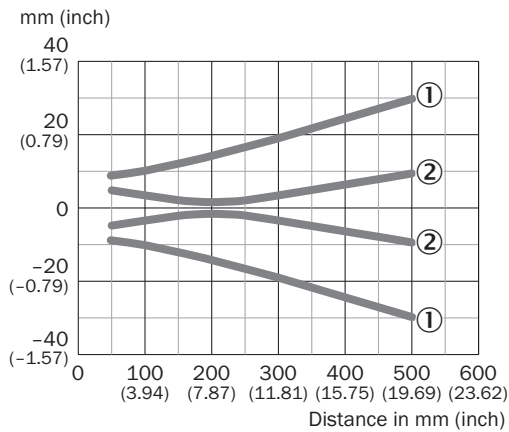

- ① Horizontal
- ② Vertical

Sensing range diagram

WTL16P-xxxx1xx

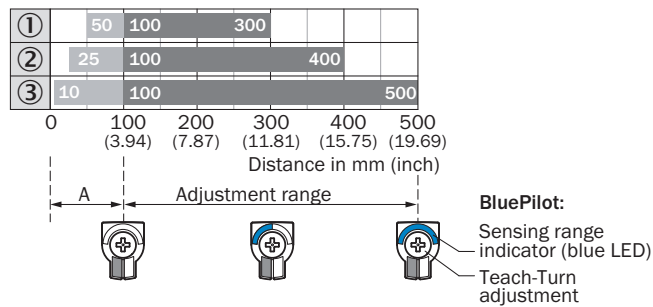

A = Detection distance (depending on object remission)

- ① Sensing range on black, 6% remission
- ② Sensing range on gray, 18 % remission
- ③ Sensing range on white, 90% remission

Dimensional drawing (Dimensions in mm (inch))



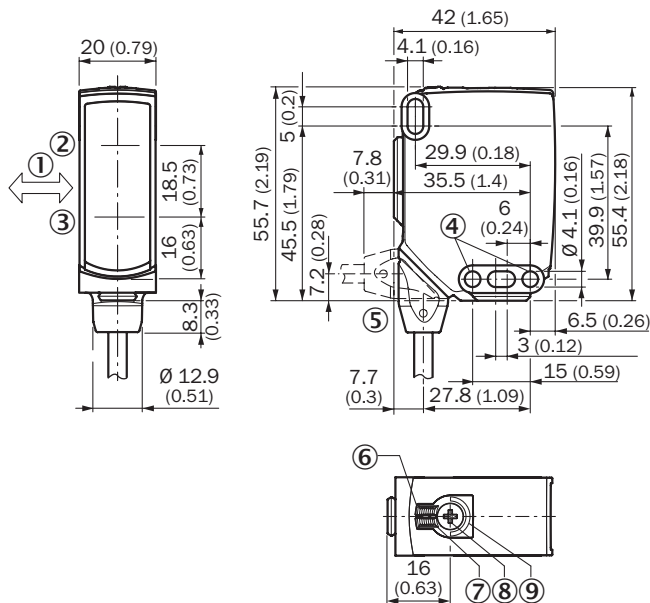

WTB16, WTL16, cable



- ① Standard direction of the material being detected
- ② Center of optical axis, sender
- ③ Center of optical axis, receiver
- ④ Mounting hole, \varnothing 4.1 mm
- ⑤ Connection
- ⑥ LED indicator green: power
- ⑦ LED indicator yellow: Status of received light beam
- ⑧ Teach-Turn adjustment of sensing range
- ⑨ BluePilot blue: sensing range indicator

Recommended accessories

Other models and accessories → www.sick.com/W16

	Brief description	Type	Part no.
Universal bar clamp systems			
	Plate N02 for universal clamp bracket, Zinc plated steel (sheet), Zinc die cast (clamping bracket), Universal clamp (5322626), mounting hardware	BEF-KHS-N02	2051608
	Bar clamp for bar diameter of 12 mm (fixing the mounting rod), Aluminum, 2 screws M6 x 30, 2 spring discs	BEF-RMC-D12	5321878
Device protection (mechanical)			
	Protective housing for universal clamp, Zinc plated steel (protective housing), Zinc die cast (clamping bracket), Universal clamp, mounting hardware	BEF-SG-W16	2096146
Mounting brackets and plates			
	Mounting bracket with articulated arm, steel, zinc coated, mounting hardware included	BEF-WN-MULTI2	2093945

	Brief description	Type	Part no.
Plug connectors and cables			
	Head A: female connector, M12, 4-pin, straight, A-coded Head B: Flying leads Cable: Sensor/actuator cable, PUR, halogen-free, unshielded, 2 m	YF2A14-020UB3XLEAX	2095607
	Head A: female connector, M12, 4-pin, straight, A-coded Head B: Flying leads Cable: Sensor/actuator cable, PVC, unshielded, 2 m	YF2A14-020VB3XLEAX	2096234
	Head A: female connector, M12, 4-pin, straight, A-coded Head B: Flying leads Cable: Sensor/actuator cable, PUR, halogen-free, unshielded, 5 m	YF2A14-050UB3XLEAX	2095608
	Head A: female connector, M12, 4-pin, straight, A-coded Head B: Flying leads Cable: Sensor/actuator cable, PVC, unshielded, 5 m	YF2A14-050VB3XLEAX	2096235
	Head A: female connector, M12, 4-pin, angled, A-coded Head B: Flying leads Cable: Sensor/actuator cable, PVC, unshielded, 2 m	YG2A14-020VB3XLEAX	2095895
	Head A: female connector, M12, 4-pin, angled, A-coded Head B: Flying leads Cable: Sensor/actuator cable, PVC, unshielded, 5 m	YG2A14-050VB3XLEAX	2095897
	Head A: female connector, M12, 4-pin, straight Head B: - Cable: unshielded	DOS-1204-G	6007302
		DOS-1204-GQU6	6042088
	Head A: female connector, M12, 4-pin, angled Head B: - Cable: unshielded	DOS-1204-W	6007303
	Head A: male connector, M12, 4-pin, straight Head B: - Cable: unshielded	STE-1204-G	6009932

SICK AT A GLANCE

SICK is one of the leading manufacturers of intelligent sensors and sensor solutions for industrial applications. A unique range of products and services creates the perfect basis for controlling processes securely and efficiently, protecting individuals from accidents and preventing damage to the environment.

We have extensive experience in a wide range of industries and understand their processes and requirements. With intelligent sensors, we can deliver exactly what our customers need. In application centers in Europe, Asia and North America, system solutions are tested and optimized in accordance with customer specifications. All this makes us a reliable supplier and development partner.

Comprehensive services complete our offering: SICK LifeTime Services provide support throughout the machine life cycle and ensure safety and productivity.

For us, that is “Sensor Intelligence.”

WORLDWIDE PRESENCE:

Contacts and other locations –www.sick.com