

MIRELLA-G2-WW

~50° wide beam compatible with LEDiL HEKLA

TECHNICAL SPECIFICATIONS:

Dimensions	Ø 49.9 mm
Height	22.6 mm
Fastening	socket
Colour	metal
Box size	480 x 280 x 300 mm
Box weight	3.7 kg
Quantity in Box	336 pcs
ROHS compliant	yes ⓘ



MATERIAL SPECIFICATIONS:



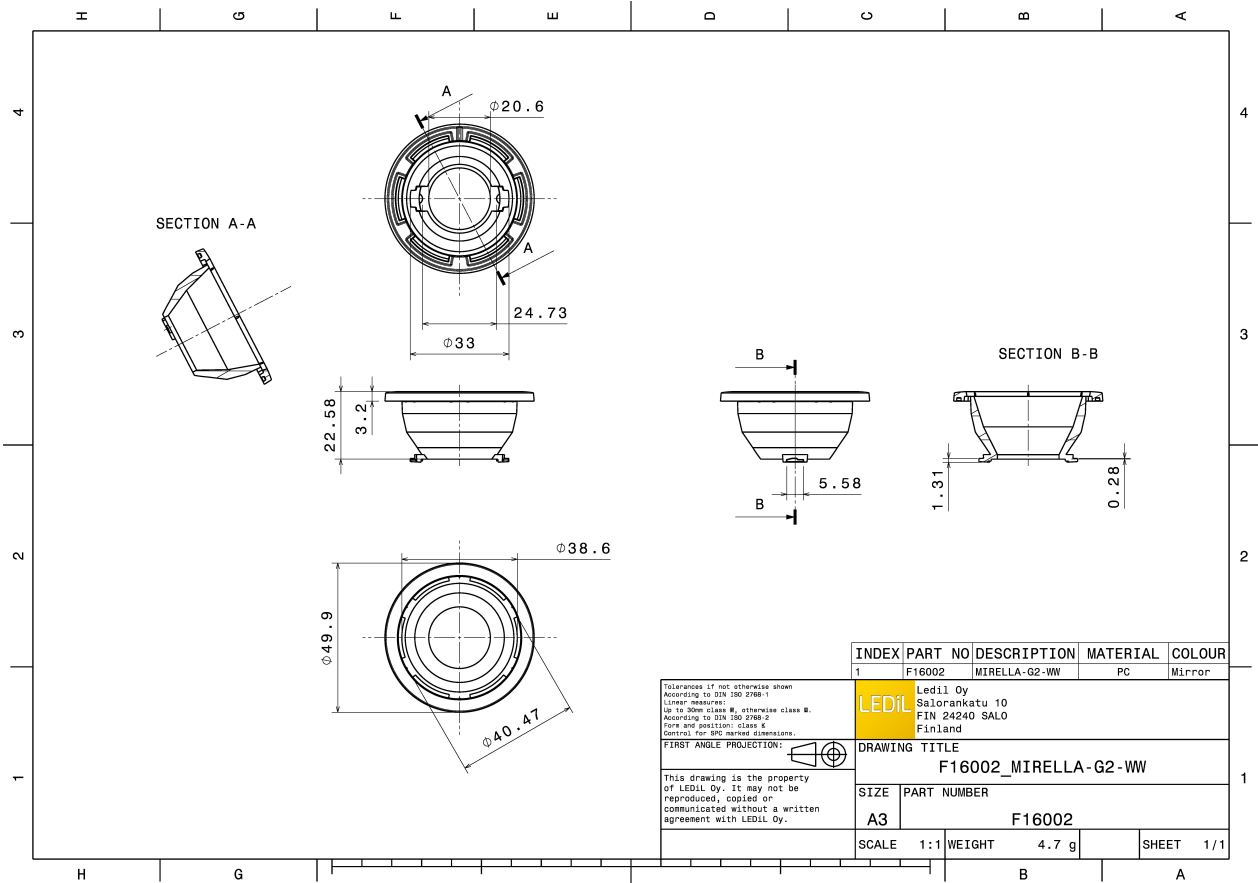

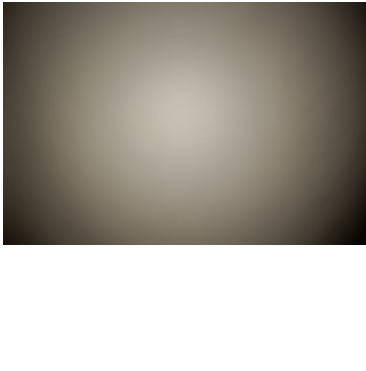
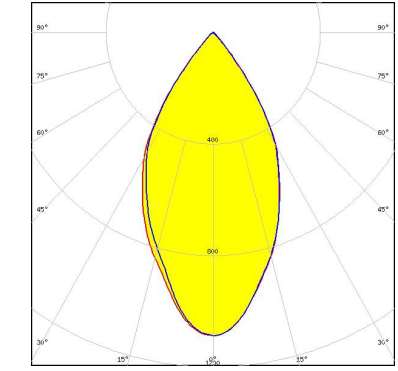
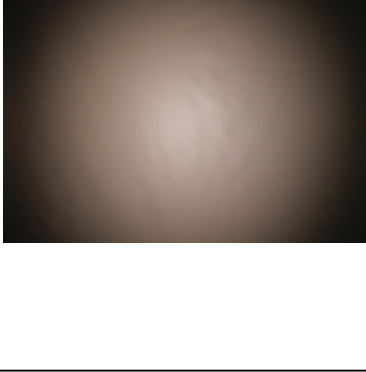
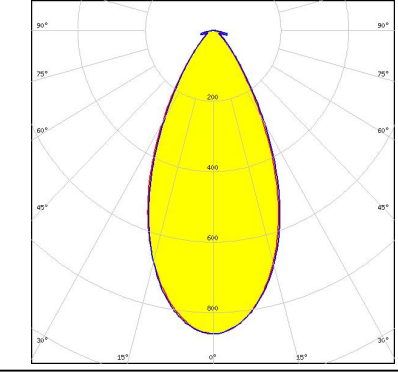
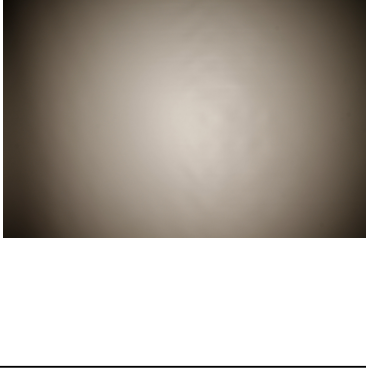
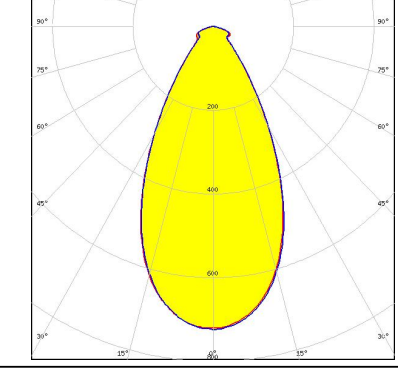
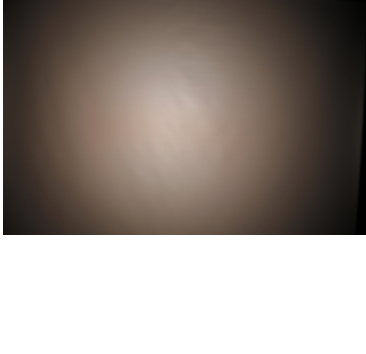
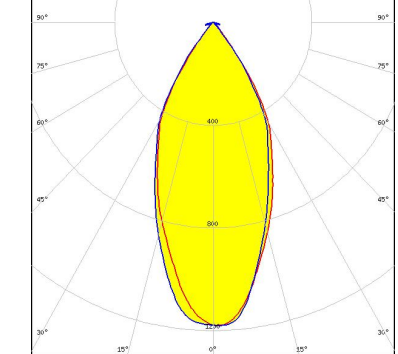

Component	Type	Material	Colour	Coating
MIRELLA-G2-WW	Reflector	PC	metal	

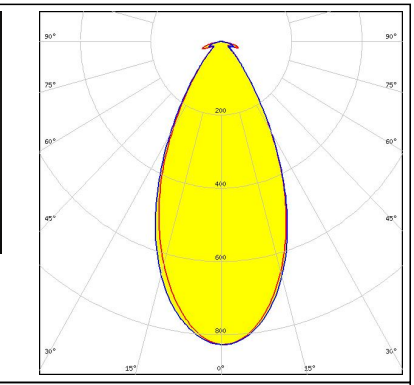

PHOTOMETRIC DATA (MEASURED):

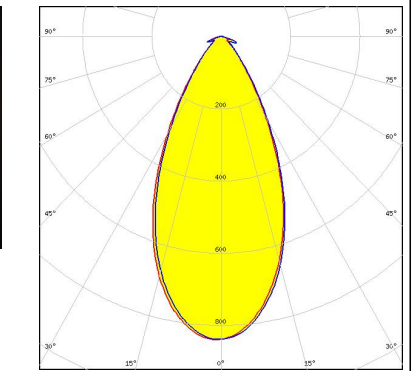
<p>bridgelux.</p> <p>LED VERO10</p> <p>FWHM 55.0°</p> <p>Efficiency 85 %</p> <p>Peak intensity 1.100 cd/lm</p> <p>Required components: F15616_HEKLA-SOCKET-F</p>		
<p>bridgelux.</p> <p>LED Vesta DTW 9mm (6W/12W)</p> <p>FWHM 50.0°</p> <p>Efficiency 71 %</p> <p>Peak intensity 0.860 cd/lm</p> <p>Required components: C16142_HEKLA-SOCKET-K C13723_MIRELLA-RZL Bender Wirth: 490 Typ L8</p>		
<p>bridgelux.</p> <p>LED Vesta TW 13mm (25W)</p> <p>FWHM 53.0°</p> <p>Efficiency 69 %</p> <p>Peak intensity 0.730 cd/lm</p> <p>Required components: C16142_HEKLA-SOCKET-K C13723_MIRELLA-RZL Bender Wirth: 492 Typ L8</p>		
<p>bridgelux.</p> <p>LED Vesta TW 9mm (12W)</p> <p>FWHM 46.0°</p> <p>Efficiency 77 %</p> <p>Peak intensity 1.200 cd/lm</p> <p>Required components: C16142_HEKLA-SOCKET-K Bender Wirth: 490 Typ L8</p>		

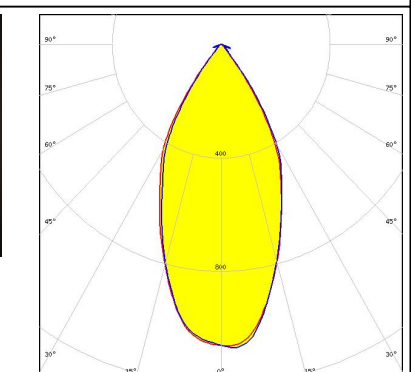
PHOTOMETRIC DATA (MEASURED):

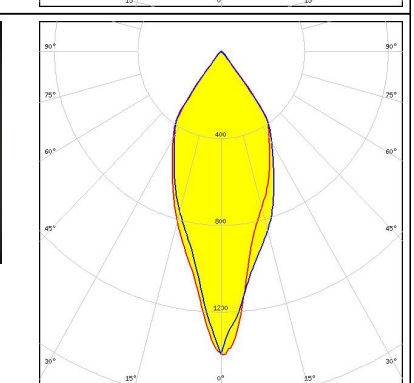
<p>bridgelux.</p> <p>LED Vesta TW 9mm (12W)</p> <p>FWHM 50.0°</p> <p>Efficiency 70 %</p> <p>Peak intensity 0.830 cd/lm</p> <p>Required components:</p> <p>C16142_HEKLA-SOCKET-K</p> <p>C13723_MIRELLA-RZL</p> <p>Bender Wirth: 489 Typ L8</p>		
<p>CITIZEN</p> <p>LED CLC020 Series (Dim-To-Warm)</p> <p>FWHM 50.0°</p> <p>Efficiency 70 %</p> <p>Peak intensity 0.840 cd/lm</p> <p>Required components:</p> <p>C16142_HEKLA-SOCKET-K</p> <p>C13723_MIRELLA-RZL</p> <p>Bender Wirth: 487 Typ L8</p>		
<p>CITIZEN</p> <p>LED CLC020 Series (Dim-To-Warm)</p> <p>FWHM 49.0°</p> <p>Efficiency 77 %</p> <p>Peak intensity 1.100 cd/lm</p> <p>Required components:</p> <p>C16142_HEKLA-SOCKET-K</p>		
<p>CITIZEN</p> <p>LED CLU LES 4.2mm (HI-Ver.3)</p> <p>FWHM 38.0°</p> <p>Efficiency 83 %</p> <p>Peak intensity 1.400 cd/lm</p> <p>Required components:</p> <p>F15255_HEKLA-SOCKET-C</p>		

PHOTOMETRIC DATA (MEASURED):

CITIZEN

LED CLU700/701
 FWHM 44.0°
 Efficiency 85 %
 Peak intensity 1.300 cd/lm
 Required components:
 F15255_HEKLA-SOCKET-C
 C13723_MIRELLA-RZL

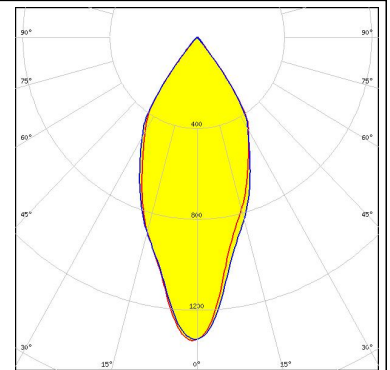

CITIZEN

LED CLU710/711
 FWHM 53.0°
 Efficiency 80 %
 Peak intensity 1.000 cd/lm
 Required components:
 F15859_HEKLA-SOCKET-I

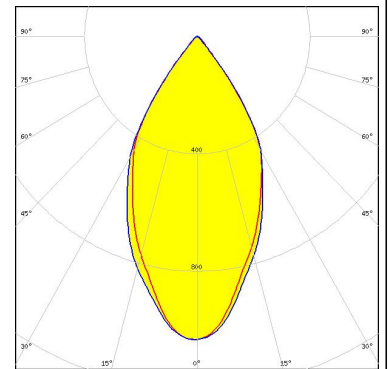
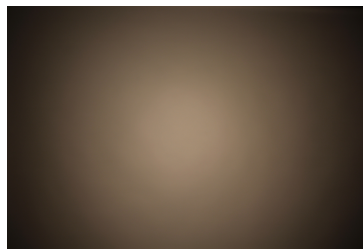

CITIZEN

LED LCN-C01B (Tunable White)
 FWHM 50.0°
 Efficiency 70 %
 Peak intensity 0.810 cd/lm
 Required components:
 C16142_HEKLA-SOCKET-K
 C13723_MIRELLA-RZL
 Bender Wirth: 481 Typ L8

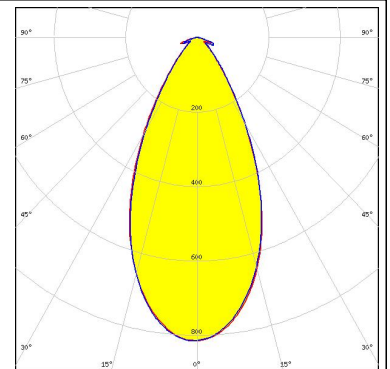
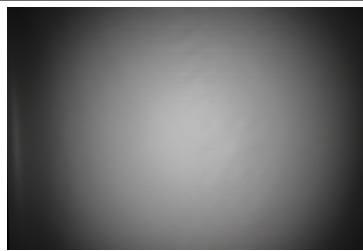

CREE

LED CMA1516
 FWHM 57.0°
 Efficiency 84 %
 Peak intensity 1.000 cd/lm
 Required components:
 F15256_HEKLA-SOCKET-D

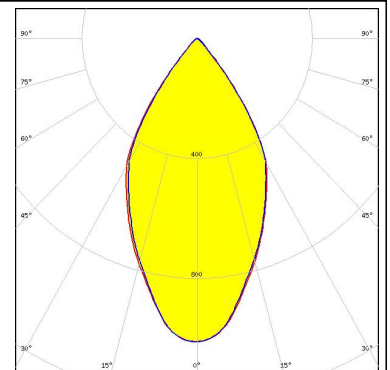
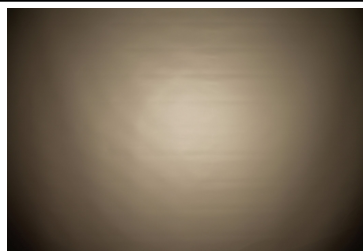

PHOTOMETRIC DATA (MEASURED):



LED CXA/B 13xx
 FWHM 43.0°
 Efficiency 86 %
 Peak intensity 1.380 cd/lm
 Required components:
 F15956_HEKLA-SOCKET-J

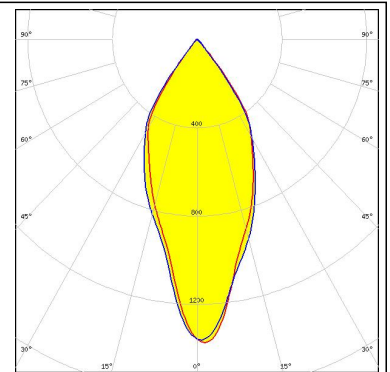

LED LUXEON CoB 1202/1203
 FWHM 56.0°
 Efficiency 83 %
 Peak intensity 1.000 cd/lm
 Required components:
 F15858_HEKLA-SOCKET-H
 C12479_MIRELLA-DL

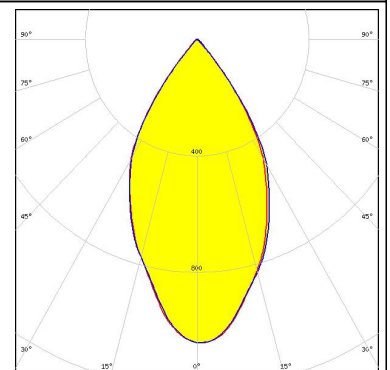
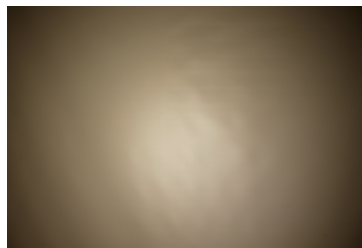



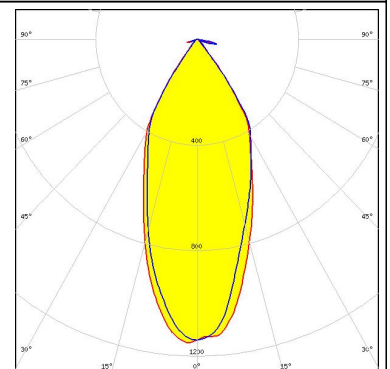
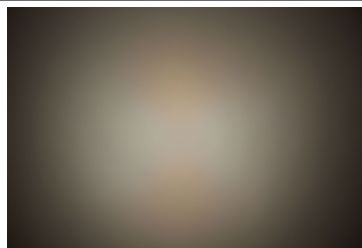

LED CDM-6 (Dim-To-Warm)
 FWHM 43.0°
 Efficiency 77 %
 Peak intensity 1.200 cd/lm
 Required components:
 C16142_HEKLA-SOCKET-K
 Bender Wirth: 490 Typ L8

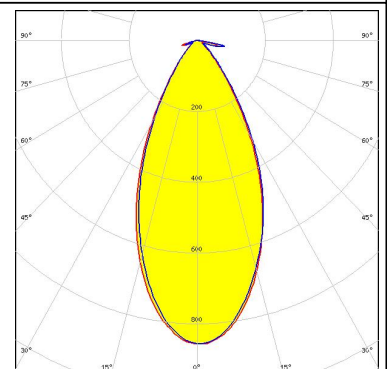
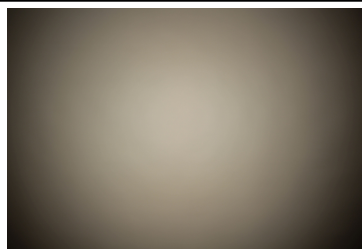

LED CDM-6 (Dim-To-Warm)
 FWHM 49.0°
 Efficiency 70 %
 Peak intensity 0.860 cd/lm
 Required components:
 C16142_HEKLA-SOCKET-K
 C13723_MIRELLA-RZL
 Bender Wirth: 490 Typ L8

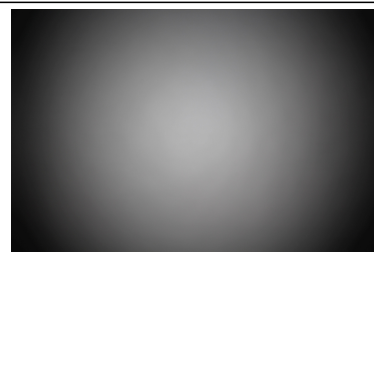
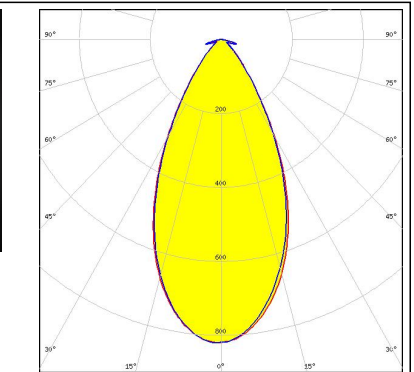

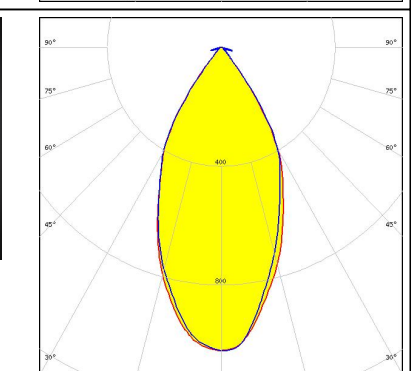
PHOTOMETRIC DATA (MEASURED):

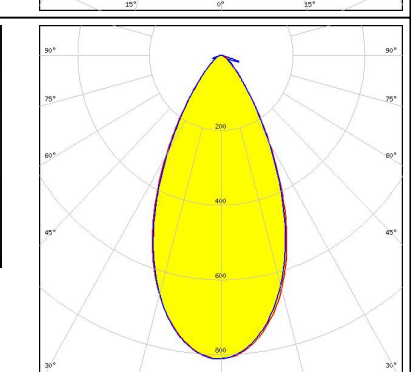
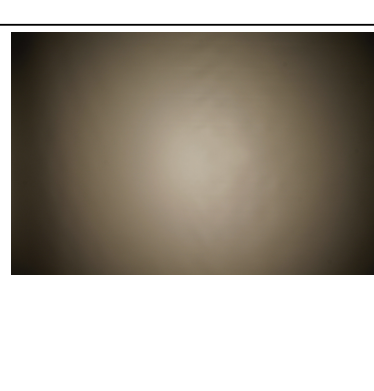
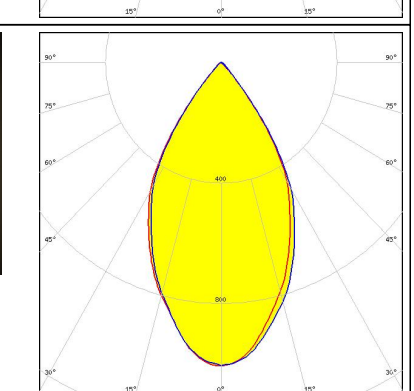
<p>LUMINUS</p> <p>LED CDM-9 (Dim-To-Warm)</p> <p>FWHM 51.0°</p> <p>Efficiency 70 %</p> <p>Peak intensity 0.820 cd/lm</p> <p>Required components:</p> <p>C16142_HEKLA-SOCKET-K</p> <p>C13723_MIRELLA-RZL</p> <p>Bender Wirth: 490 Typ L8</p>		
<p>LUMINUS</p> <p>LED CDM-9 (Dim-To-Warm)</p> <p>FWHM 49.0°</p> <p>Efficiency 76 %</p> <p>Peak intensity 1.000 cd/lm</p> <p>Required components:</p> <p>C16142_HEKLA-SOCKET-K</p> <p>Bender Wirth: 490 Typ L8</p>		
<p>LUMINUS</p> <p>LED CTM-9 (Tunable White)</p> <p>FWHM 51.0°</p> <p>Efficiency 68 %</p> <p>Peak intensity 0.800 cd/lm</p> <p>Required components:</p> <p>C16142_HEKLA-SOCKET-K</p> <p>C13723_MIRELLA-RZL</p> <p>Bender Wirth: 495 Typ L8</p>		
<p>LUMINUS</p> <p>LED CXM-9</p> <p>FWHM 57.0°</p> <p>Efficiency 82 %</p> <p>Peak intensity 1.000 cd/lm</p> <p>Required components:</p> <p>F15255_HEKLA-SOCKET-C</p>		

PHOTOMETRIC DATA (MEASURED):

SAMSUNG

LED LC010C G2
FWHM 45.0°
Efficiency 82 %
Peak intensity 1.200 cd/lm
Required components:
F15255_HEKLA-SOCKET-C

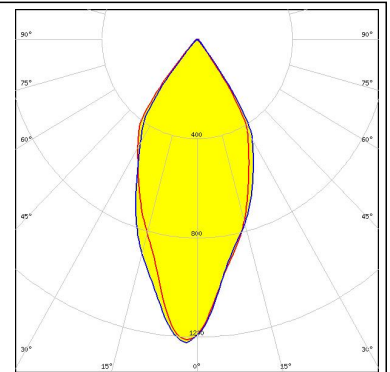
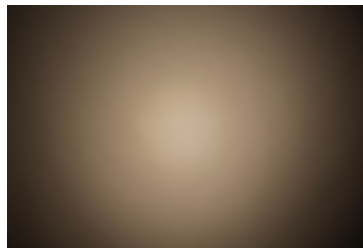

SAMSUNG

LED LC020C
FWHM 56.0°
Efficiency 83 %
Peak intensity 1.000 cd/lm
Required components:
F15848_HEKLA-SOCKET-G

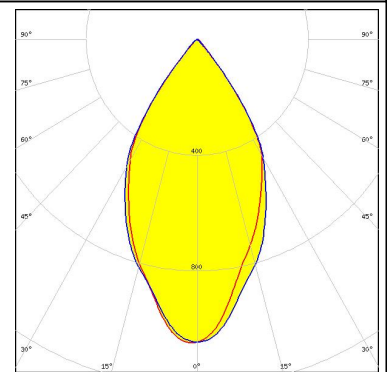

PHOTOMETRIC DATA (SIMULATED):



LED VERO13
FWHM 53.0°
Efficiency 83 %
Peak intensity 1.100 cd/lm
Required components:
C16142_HEKLA-SOCKET-K

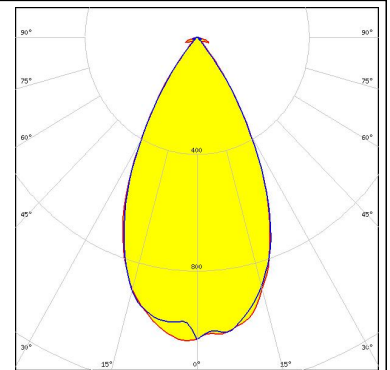

CITIZEN

LED CLL02x/CLU02x (LES10)
FWHM 61.2°
Efficiency 86 %
Peak intensity 0.980 cd/lm
Required components:
F15255_HEKLA-SOCKET-C

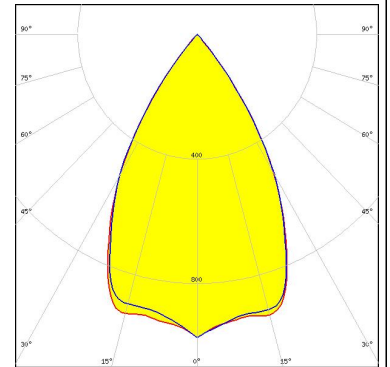

LED COB L-Type (LES 11)
FWHM 61.0°
Efficiency 88 %
Peak intensity 0.990 cd/lm
Required components:
F15858_HEKLA-SOCKET-H

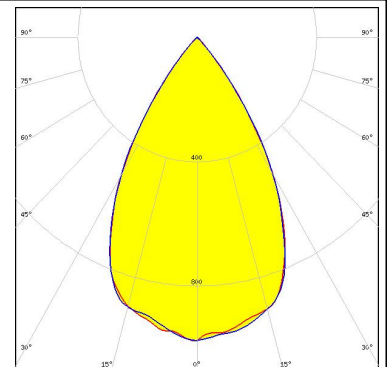

TRIDONIC

LED SLE G6 LES10
FWHM 58.0°
Efficiency 88 %
Peak intensity 1.080 cd/lm
Required components:
F15255_HEKLA-SOCKET-C

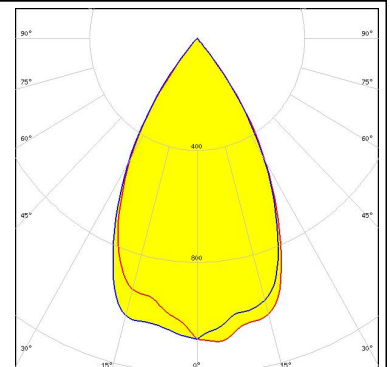

GENERAL INFORMATION:

NOTE: The typical beam angle will be changed by different color, chip size and chip position tolerance. The typical total beam angle is the full angle measured where the luminous intensity is half of the peak value.

Due to use of high power COB's with this product, special attention to proper thermal design is highly recommended. LEDiL has no liability for direct, indirect or consecutive damages arising from the LEDiL products being used outside of the recommended temperature range.

MATERIALS:

As part of our continuous research and improvement processes, and to ensure the best possible quality and availability of our products, LEDiL reserves the right to change material grades without notice.

PRODUCT DATA USER AGREEMENT AND DISCLAIMER:

The measured data in the provided downloadable LEDiL Product Datasheets and Mechanical 2D-Drawings is rounded and provided as reference for planning. LEDiL Oy's optical specifications have been verified by conducting performance testing of the products in accordance with the company's quality system. The reported data are averaged results of multiple measurements with typical variation. LEDiL Oy reserves the right to without prior notification make changes and improvements to its products.

LEDiL Oy assumes neither warranty, nor guarantee nor any other liability of any kind for the contents and correctness of the provided data. The provided data has been generated with highest diligence but the provided data may in reality not represent the complete possible variation range of all intrinsic parameters. Therefore, in certain cases a deviation from the provided data could occur.

LEDiL Oy reserves the right to undertake technical changes of its products without further notification which could lead to changes in the provided data. LEDiL Oy assumes no liability of any kind for the possible deviation from any provided data or any other damage resulting from the usage of the provided data.

The user agrees to this disclaimer and user agreement with the download or usage of the provided files.

LEDiL Oy

Joensuunkatu 13
FI-24240 SALO
Finland

LEDiL Inc.

228 West Page Street
Suite D
Sycamore IL 60178
USA

Local sales and technical support

www.ledil.com/where_to_buy

Shipping locations

Salo, Finland
Hong Kong, China

Distribution Partners

www.ledil.com/where_to_buy