

Project 0

What is Arduino

00

What is Arduino?

Arduino is an open-source electronics prototyping platform based on flexible, easy-to-use hardware and software. It is intended for artists, designers, hobbyists and anyone interested in creating interactive objects or developing environments.

Arduino can sense its environment by receiving inputs from sensors, and interact with its environment by controlling lights, motors, or other actuators. The Arduino integrated development environment (IDE) is a cross-platform application written in Java, and is derived from the IDE for the Processing programming language and wiring projects. It can run independently and communicate with other software such as Flash, Processing, MaxMSP and more. Arduino IDE is open source so you can download and share thousands of interactive projects for free!

Here are some Arduino projects just to give your some ideas of tasks it can complete.

```
// make sound notification when coffee is done
// email notification via mobile
// blinking fluffy toy
// Professor X's steam punk wheel chair with voice recognition and drink serving function
// a Star War arm gun
// a pulse monitor to store data when biking
// a robot that can run in snow and draw pictures on the floor
```

History

Arduino started in 2005 as a project for students at the Interaction Design Institute Ivrea in Ivrea, Italy. At that time, programming students used a "BASIC Stamp" for projects. This was at a cost of \$100, considered expensive for students.

Massimo Banzi, one of the founders of Arduino, taught at Ivrea. The name "Arduino" comes from a bar in Ivrea where some of the founders of the project used to meet. The bar itself was named after Arduino, Margrave of Ivrea and King of Italy from 1002 to 1014.

Colombian student Hernando Barragan contributed a hardware thesis for a wiring design. After the wiring platform was complete, researchers worked to make it lighter, less expensive, and available to the open source community. The school eventually closed down, so these researchers, including a man called David Cuartielles, promoted the idea. This idea was to become the Arduino as we know it today.

Arduino UNO

Now let's take a close look at the Arduino micro-controller and try to locate I/O ports (input/output) and on board LEDs.

- ◆ I/ O pins, digital pins 0-13, analog pins 0-5.
- ◆ 2 power sources. One is the USB port that can draw power from the USB connection. Another is power jack that inputs DC power of 6-12 volts.
- ◆ 4 LEDs and reset button. L is the on board LED that connects with digital pin 13. TX and RX are indicators of transmission signal and received signal. When we download a sketch to the Arduino, these two lights blink, indicating that data is being transmitted and received.

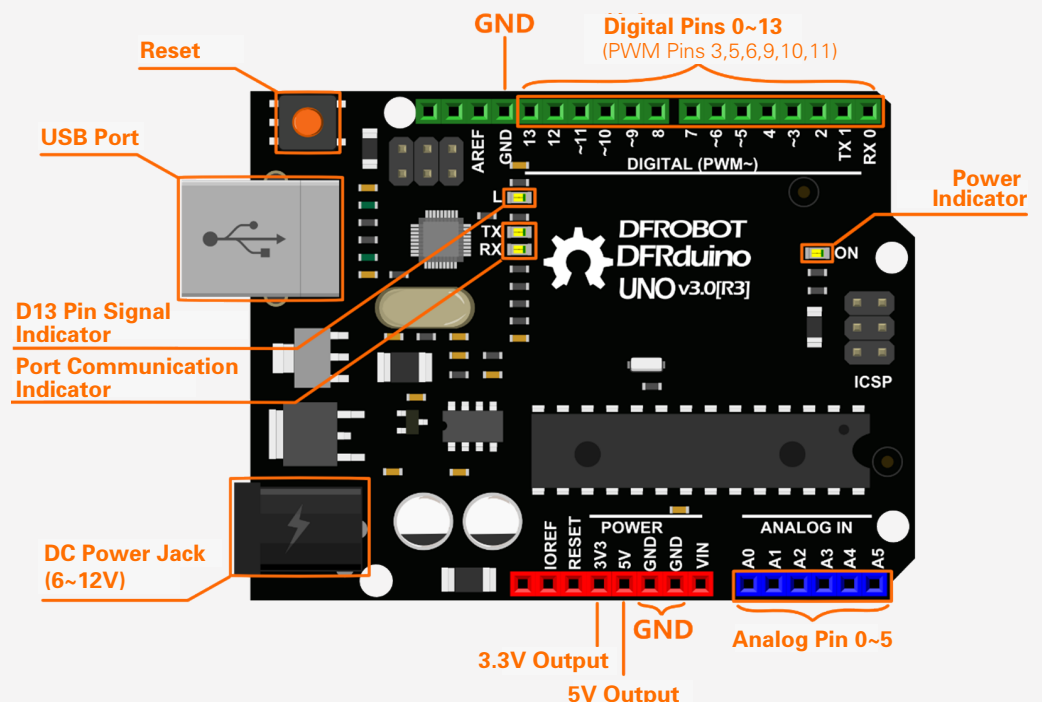

First Use

1. Download Arduino IDE

Go to <http://arduino.cc/en/Main/Software> to download the installation file according to your operation system.

Arduino 1.0.5

Download

Arduino 1.0.5 (release notes), hosted by [Google Code](#):

NOTICE: Arduino Drivers have been updated to add support for Windows 8.1, you can download the updated IDE (version 1.0.5-r2 for Windows) from the download links below.

- [Windows Installer, Windows \(ZIP file\)](#)
- [Mac OS X](#)
- [Linux: 32 bit, 64 bit](#)
- [source](#)

For Windows users, please follow the instructions below. For Mac and Linux users, you can directly use the Arduino sketch by simply clicking on the file.

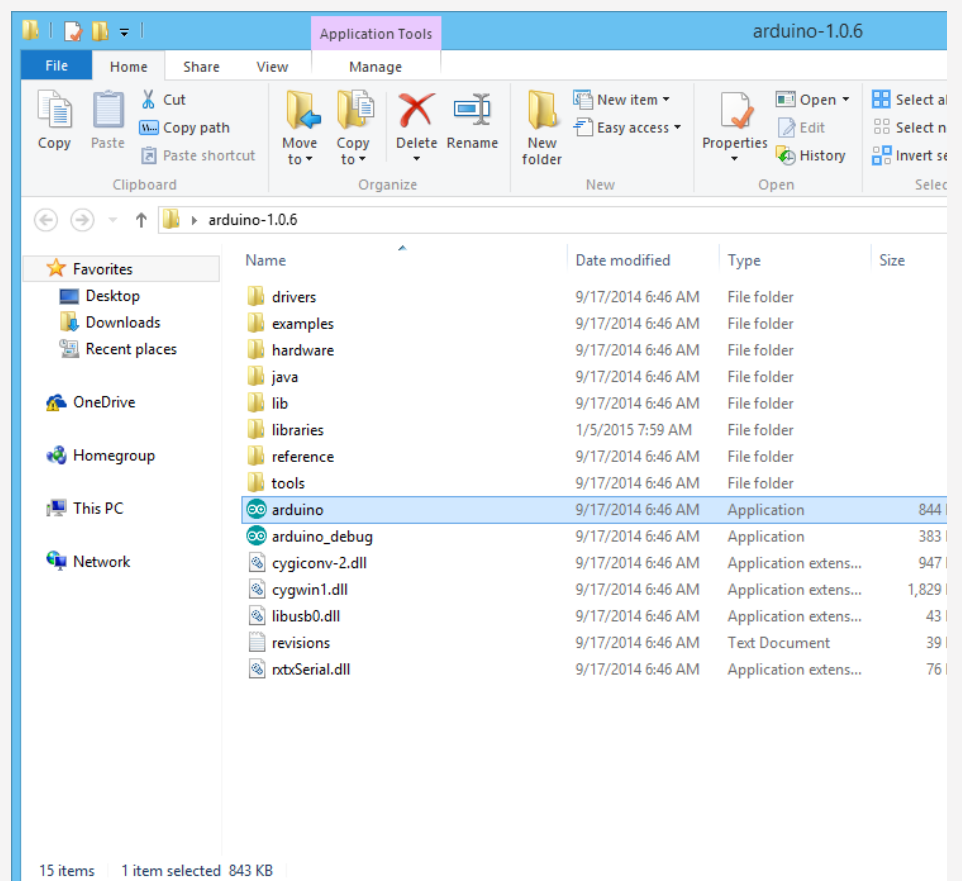

2. Install the drivers

Installing drivers for the Arduino Uno with Windows 7, Vista, or XP: Plug in your board and wait for Windows to begin its driver installation process. After a few moments, despite its best efforts, the process will fail, but do not panic! Click on the Start Menu, and open up the Control Panel.

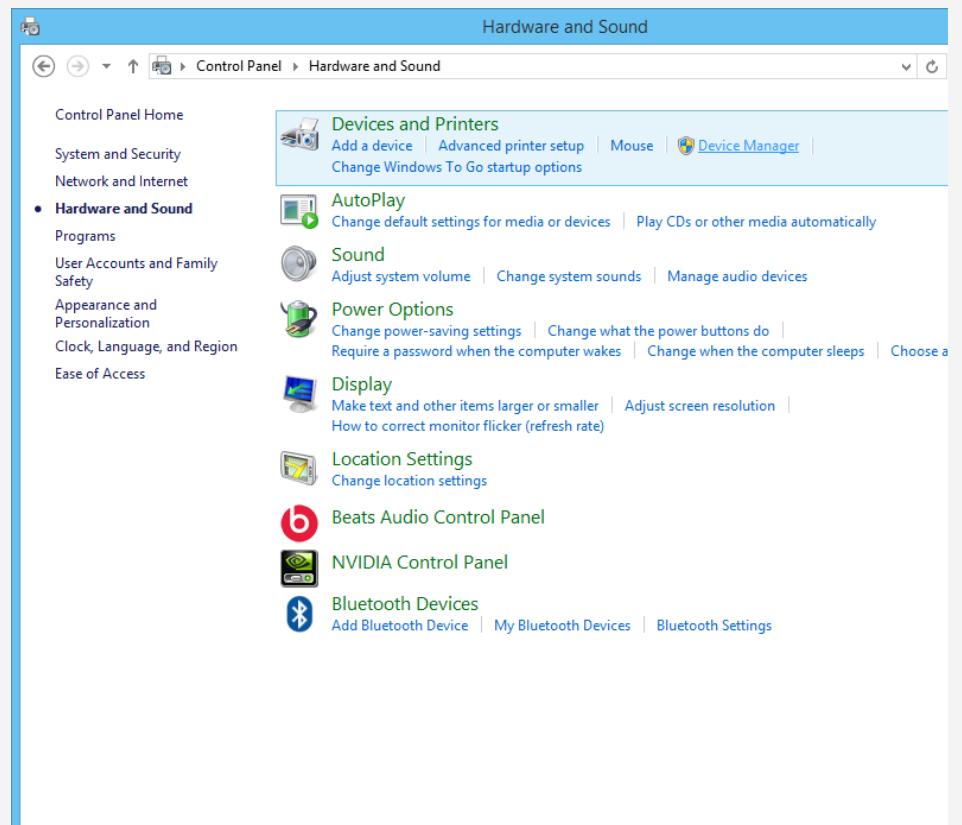

Find "Unknown Device" and then right click and select "Update Driver Software".

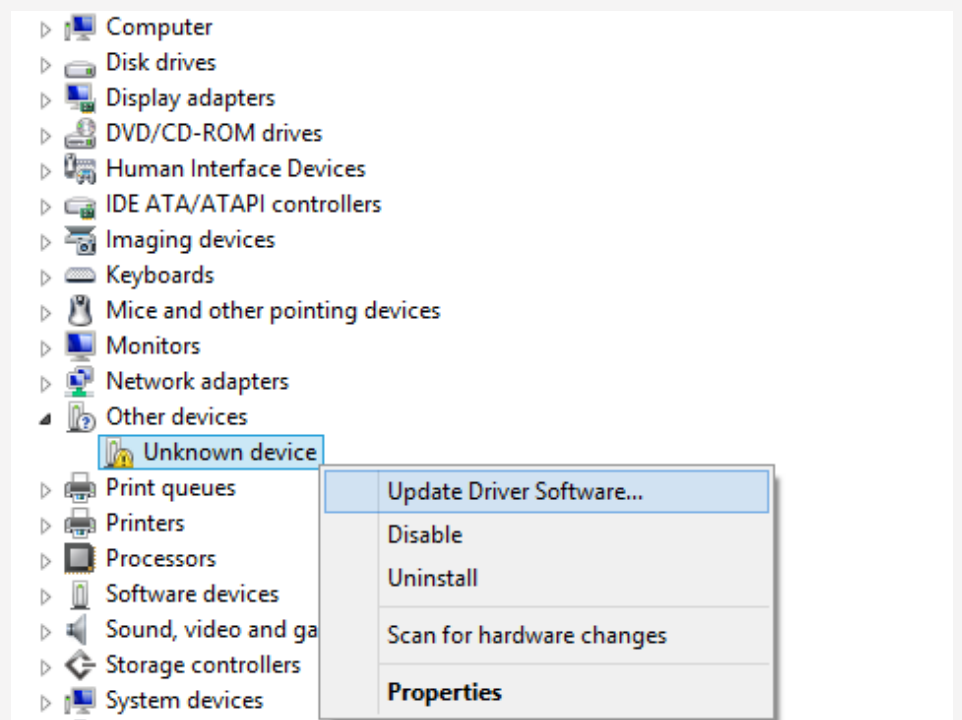

Choose **"Browse my computer for driver software"** to search for drivers manually.

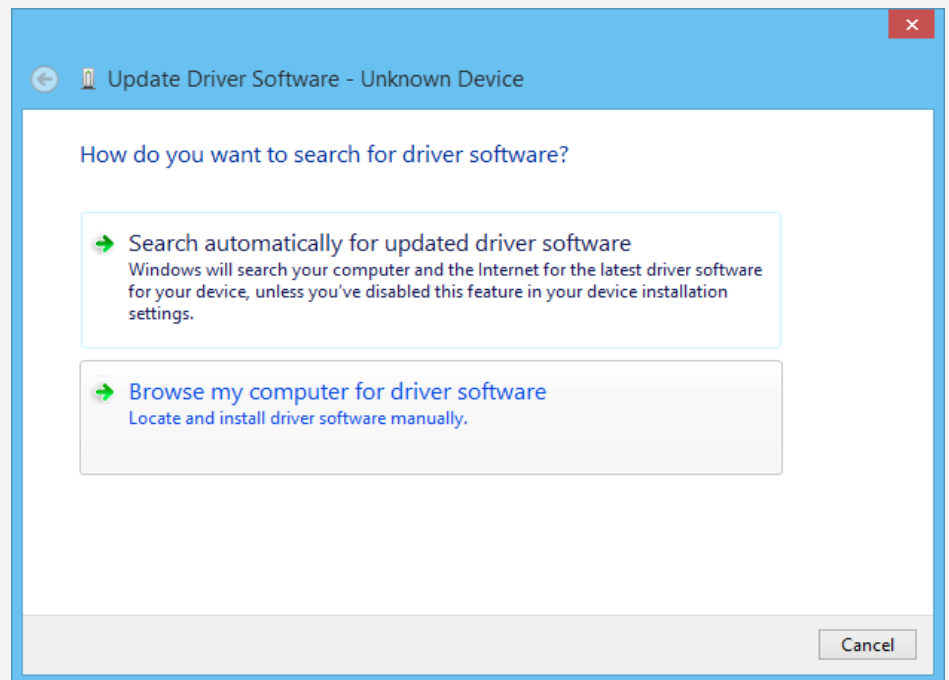

Click **"Browse"** and find the directory location of the Arduino IDE (where the installation files are located). Inside this directory will be another directory named **"Drivers"**. Select it and click **"Next"**.



This dialog indicates successful installation. Hopefully this is what you will see! If not, double check your steps and try again.

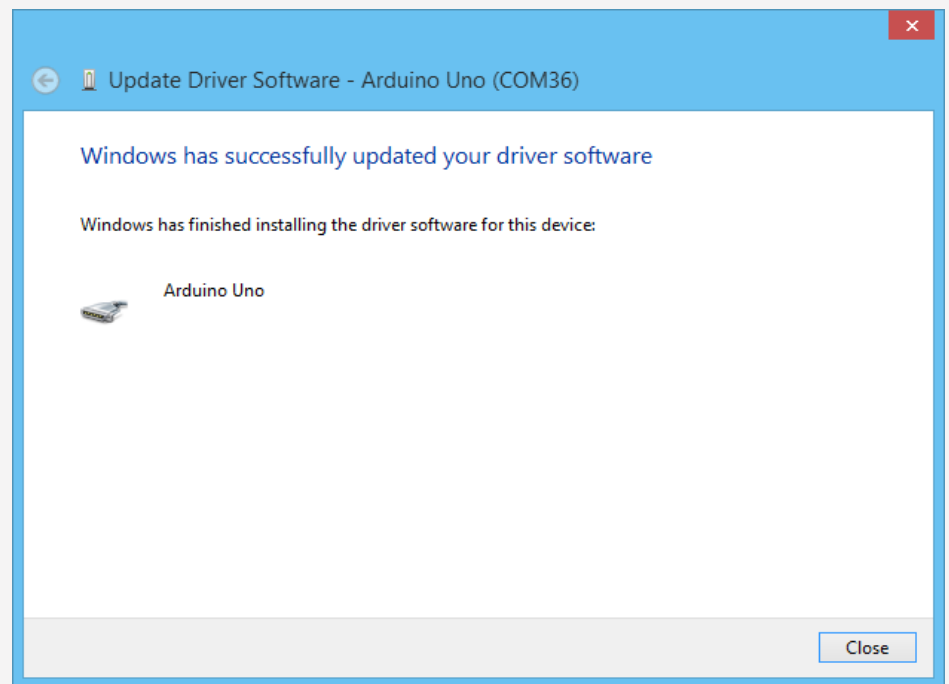

If you go back to your device manager, the Arduino device should now be recognised by your computer.

Go to "Device Manager" > "Ports (COM & LPT)". You should see "Arduino Uno (COM#)". This is the COM port that your computer uses to transfer data to your Arduino. In our example the computer communicates with the Arduino on COM36.

Remember your COM number as you will need it later.

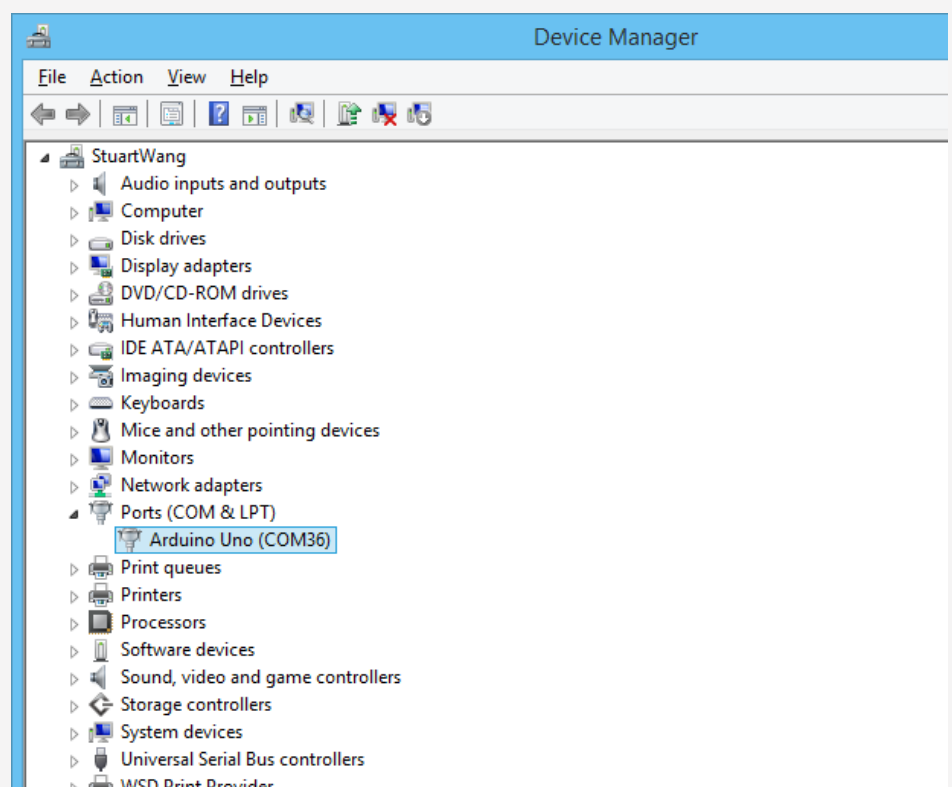

4. Upload a Blink program

Open Arduino IDE and take a moment to move your mouse along each icon to get to know their functions. Here we will use a very basic sample code, "Blink" to go through the whole process and test whether the controller is working.

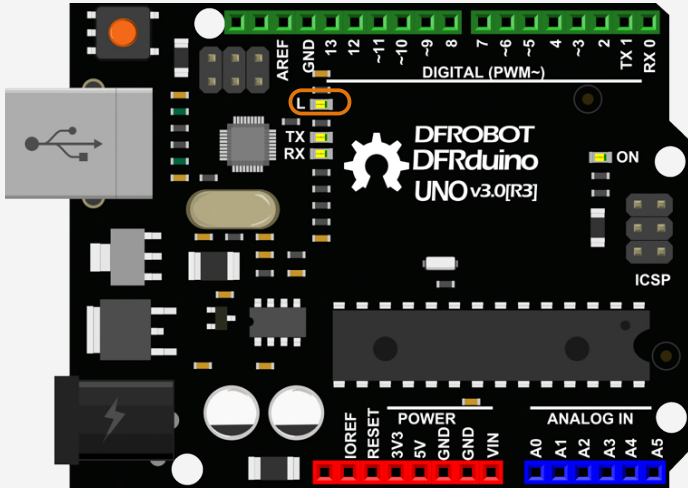

Open the LED blink example sketch. You will find it under "File > Examples > 01.Basics > Blink".

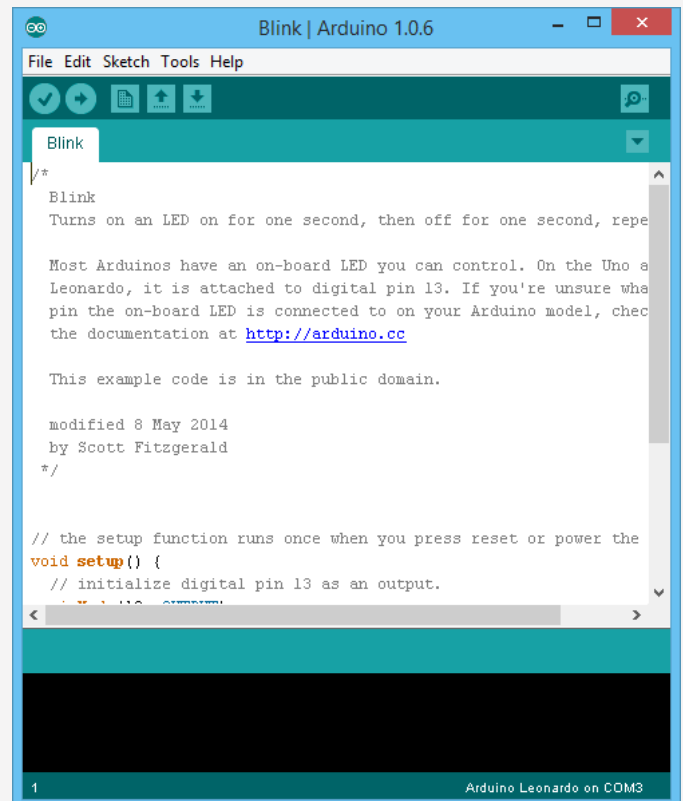
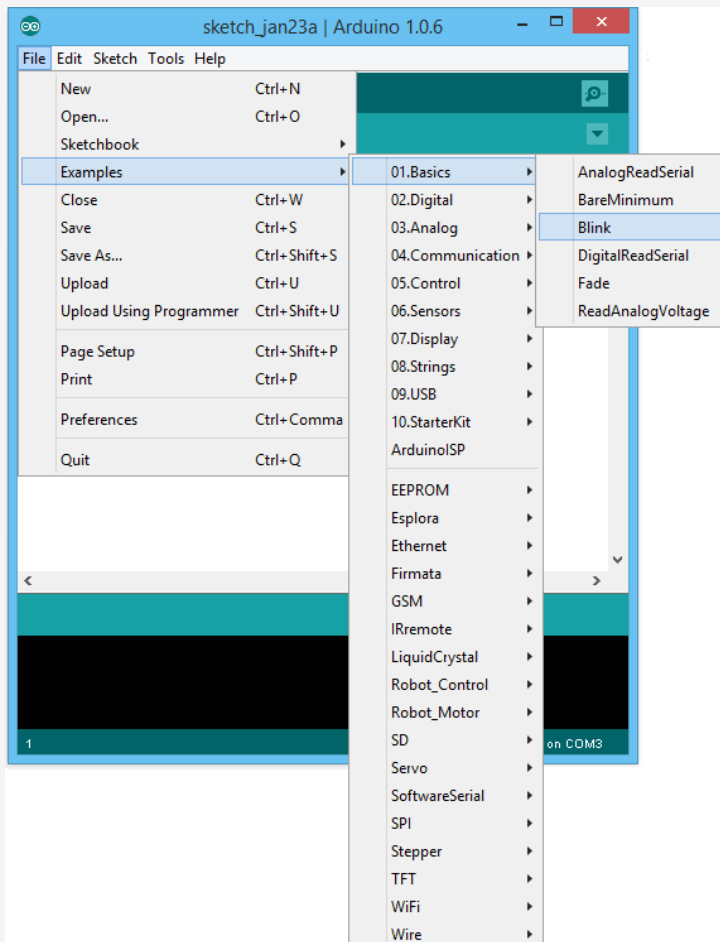

Click **"Verify"** to compile your code. The IDE changes the code from text into instructions that the computer can understand. This process is called **compiling**.



Verifying...



Finished !

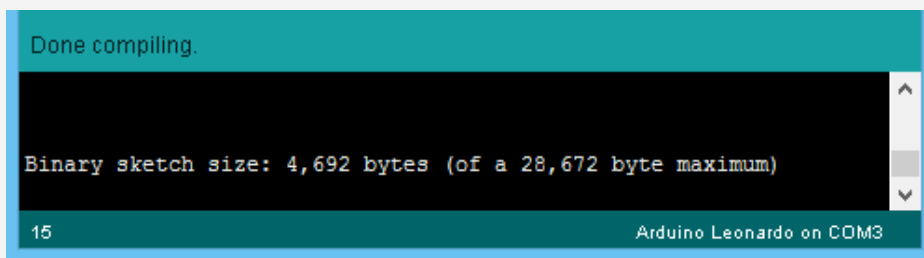

The code we are using should not have errors since it is an example code. If a code does have errors in it, it will fail to verify.

Time to download the code to your Arduino! Select your micro controller by selecting “Board > Arduino UNO”.

Then select your COM port by selecting “Serial Port” and selecting the COM port number you saw earlier. In our example, COM36 is in use.

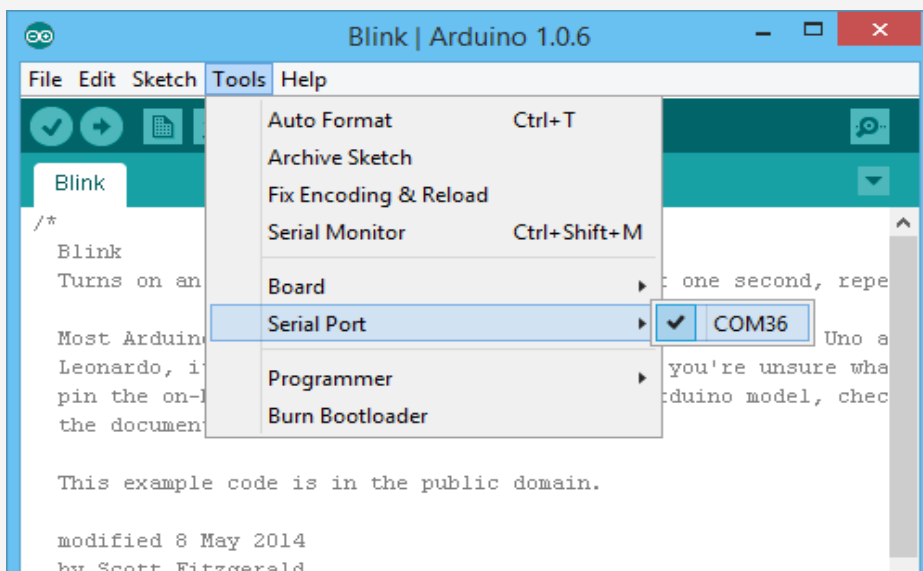
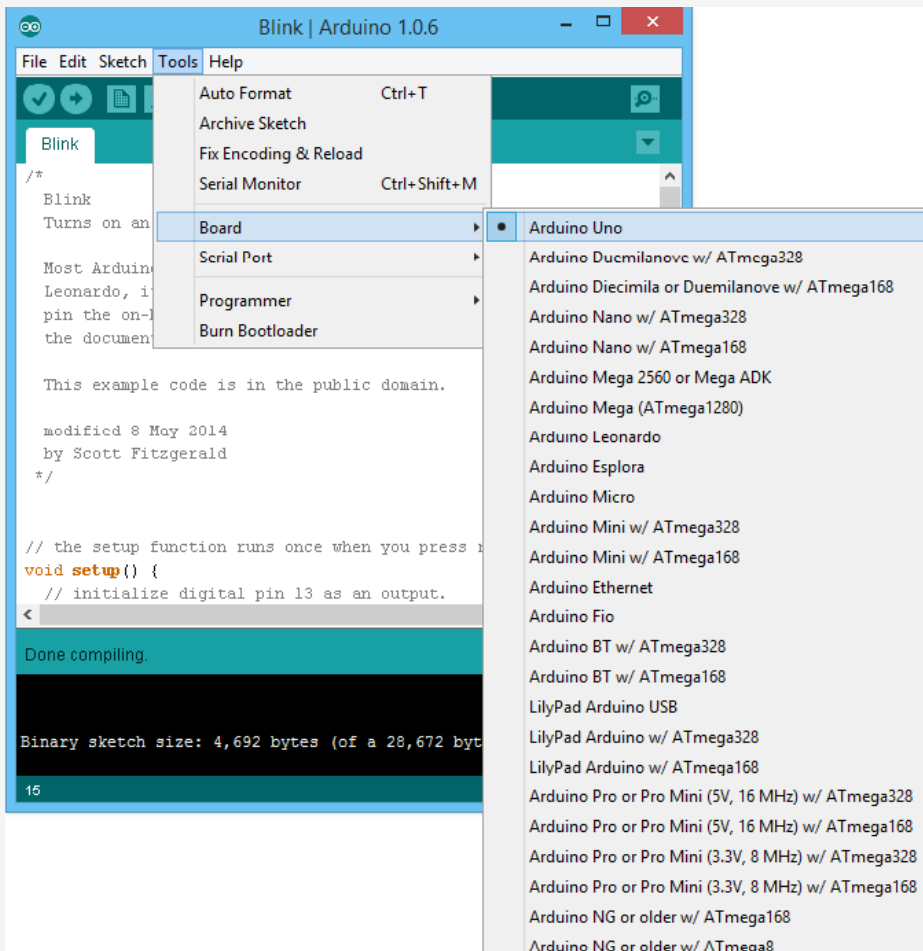

Click "Upload" to send the instructions via the USB cable to the Arduino.

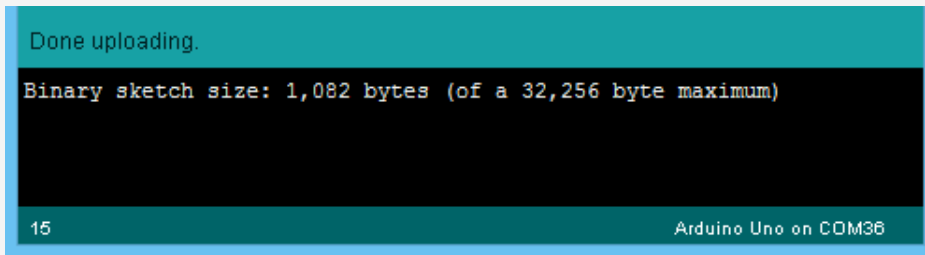

After it is finished, the Arduino will run the code automatically and the onboard LED will start to blink, just as programmed!

Review

In order to upload code, we must do the following steps:

Verify Code > Choose Board and Port > Upload

...then your sketch will be uploaded.

Project 1

LED Flashing

01

Let's get started!

Let's kickstart our Arduino adventure! In the first lesson, you will learn the basics of components such as LEDs, buttons and resistors - including pull-up and pull-down resistors. Additionally, you will start to write Arduino sketches to control a LED with your Arduino.

LED Flashing

In the first project, we will use the “Blink” sketch again but with a proper LED instead of the on-board LED. Through this, we can have a clear idea of how a LED works and how they can be used in a circuit.

Required Components:

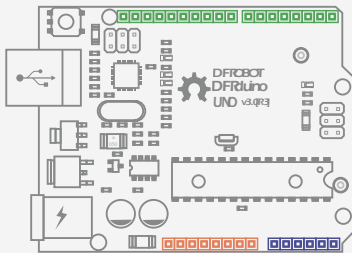

DFRduino UNO R3

x1

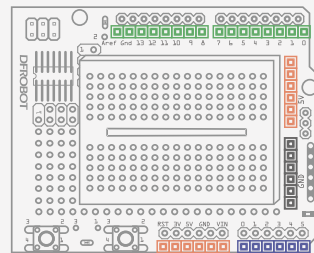

Prototype Shield with Breadboard

x1



Jumper
M/M

x2



Resistor 220R

x1



5MM LED

x1

*You may need to choose a different value resistor depending on the LED you will use. We will mention how to calculate resistance value in the latter part of this lesson.

*DFRduino is DF Robot's signature Arduino board and functions the same as any other Arduino board.

Hardware

To build the circuit, you need to take your Arduino and stack the Prototype Shield on top of it.

The male header pins on the bottom of the Prototype Shield should line up and slide in to the female headers on the Arduino easily. Be gentle and be careful not to bend them.

Peel the adhesive strip off the back of the Breadboard and then stick it on to the Prototype Shield. You can now set up the circuit according to the picture below.

It is standard practice to use wires of different colored insulation for your own reference, but using different combinations of colors won't stop the circuit working.

Normally red wire indicates power supply (**Vcc**), black wire indicates ground (**GND**), green wire indicates digital pins, blue wire indicates analog pins, and white is other.

Double check the orientation of LED leads on the circuit. LEDs are **polarized** (will only work if placed in the circuit the correct way around). The long leg of the LED connects to Vcc. (In this example Pin 10) and the short leg connects to GND.

When you finish the circuit, connect the Arduino controller and computer with the provided USB cable.

DF Wiring Definitions:

Green:	Digital Connections
Blue:	Analog Connections
Red:	Vcc Power Supply
Black:	GND
White:	Other

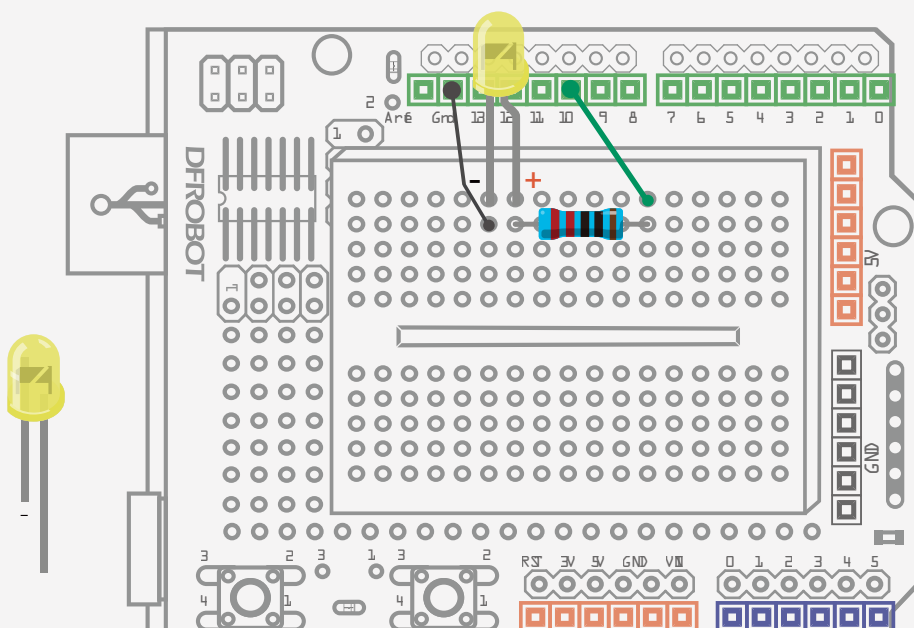

Fig 1-1 LED Flashing Circuit

Arduino Sketch

Open the Arduino IDE and enter the code as sample code 1-1 shows. (We highly recommend you type code instead of copying and pasting so that you can develop your coding skills and learn to code by heart.)

The sample code 1-1:

```
//Project -- Blinking a LED
/*
  Description: turn LED on and off every other second.
*/
int ledPin = 10;
void setup() {
  pinMode(ledPin, OUTPUT);
}
void loop() {
  digitalWrite(ledPin,HIGH);
  delay(1000);
  digitalWrite(ledPin,LOW);
  delay(1000);
}
```

When you've finished entering the code, click on **"Verify"** to check if the code can be compiled. If the code has no errors, click **"Upload"** to upload code to the micro-controller. Now your onboard LED should be blinking on and off.

CODE

Comments:

```
// Project -- blink a LED
```

Any line of code that has `"/"` put before it will not be compiled by the compiler. The Arduino IDE indicates this by turning the line of code grey automatically. This allows you to write plain English descriptions of the code you or others have written and makes it easier for other people who might not be able to read code to understand. We refer to this as **commenting out**.

Multi-Line Comments:

```
/* the text between these two
symbols will be commented out;
the compiler will ignore the text
and the text will appear gray */
```

Similar to single line comments, any text between `/ *` and `* /` will be ignored by the compiler. Once again, the Arduino IDE will turn this text grey to show that it is commented out. This is a useful way of annotating code.

Declaring Variables:

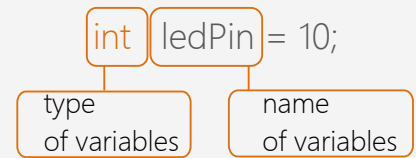

Declaring variables is a useful way of naming and storing values for later use by the program. **Integers** (`int`) represent numbers ranging from -32768 to 32767. In the above example, we have input an integer: 10. `"ledPin"` is the variable name we have chosen. Of course, you may name it anything you like instead of `ledPin`, but it's better to name the variable according to its function. Here the variable `ledPin` indicates that the LED is connected to Pin-out 10 of Arduino. Use a semicolon (`;`) to conclude the declaration. If you don't use the semicolon, the program will not recognise the declaration, so this is important!

What is a variable?

A variable is a place to store a piece of data. It has a name, a value, and a type. In the above example, `"int"` (integer) is the type, `"ledPin"` is the name and `"10"` is the value. In this example we're declaring a variable named `ledPin` of type `"int"` (integer), meaning the LED is connected to digital pin 10. Variables display as orange text in the sketch.

Integers can store numbers from -32768 to 32767. You must introduce, or declare variables before you use them. Later on in the program, you can simply type the variable name rather than typing out the data over and over again in each line of code, at which point its value will be looked up and used by the IDE.

When you try to name a variable, start it with a letter followed with letter, number or underscore. The language we are using (C) is case sensitive. There are certain names that you cannot use such as `"main"`, `"if"`, `"while"` as these have their own pre-assigned function in the IDE.

Don't forget the variable names are case-sensitive!

The setup() function

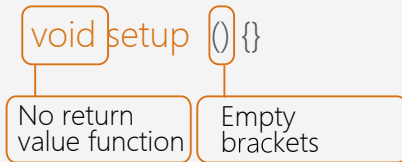

In this example there is only one line in the setup() function:
pinMode

```
pinMode(ledPin, OUTPUT);
```

The function format is as follows:

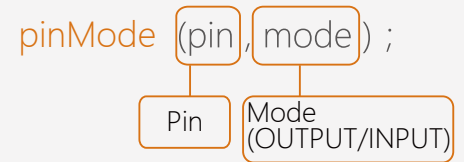

The setup() function is read by the Arduino when a sketch starts. It is used to initialize variables, pin modes, initialize libraries, etc. The setup function will only run once after each power-up or reset of the Arduino board.

This function is used to define digital pin working behavior. Digital pins are defined as an **input** (INPUT) or an **output** (OUTPUT). In the example above you can see brackets containing two parameters: the variable (ledPin) and its behaviour (OUTPUT).

“pinMode” configures the specified digital pin to behave either as an input or an output. It has two parameters:
 “pin”: the number of the pin whose mode you wish to set
 “mode”: INPUT, OUTPUT, or INPUT_PULLUP.

If you want to set the digital pin 2 to input mode, what code would you type?

Answer: pinMode (2, INPUT);

Function

Segmenting code into functions allows a programmer to create modular pieces of code that perform a defined task and then return to the area of code from which the function was "called". The typical case for creating a function is when one needs to perform the same action **multiple times in a program**.

There are two required functions in an Arduino sketch, setup() and loop(). Other functions must be created outside the brackets of those two functions.

Difference of INPUT and OUTPUT

INPUT is signal that sent from outside events to Arduino such as button. OUTPUT is signal that sent from Arduino to the environment such as LED and buzzer.

If we scroll further down, we can see the main part of the code. This is the **loop**.

```
void loop() {
  digitalWrite(ledPin,HIGH);
  delay(1000);
  digitalWrite(ledPin,LOW);
  delay(1000);
}
```

The Arduino program must include the `setup ()` and `loop ()` function, otherwise it won't work. After creating a `setup()` function, which initializes and sets the initial values, the `loop()` function does precisely what its name suggests, and loops consecutively, allowing your program to change and respond. Use it to actively control the Arduino board. Here we want to control the LED constantly on and off every other second. How can we make that happen?

In this project we want the LED to turn on for 1 second and then turn off for 1 second, and repeat this action over and over. How can we express this in code?

Look at the `loop ()` function within the first statement.

This involves another function: `digitalWrite ()`.

```
digitalWrite(ledPin,HIGH);
```

The function format is as follows:

```
digitalWrite (pin , value ) ;
```

`digitalWrite` writes a "HIGH" (on) or a "LOW" (off) value to a digital pin. If the pin has been configured as an OUTPUT with `pinMode()`, its voltage will be set to the corresponding value: 5V (or 3.3V on 3.3V boards) for HIGH and 0V (ground) for LOW. Please note that `digitalWrite()` is applied only under the condition that `pinMode()` is set as OUTPUT. Why? Read on!

The Relation of `pinMode()`, `digitalWrite()` and `digitalRead()`

If `pinMode` configures a digital pin to behave as an input, you should use the `digitalRead()` function. If the pin is configured as an output, then you should use `digitalWrite()`.

NOTE: If you do not set the `pinMode()` to OUTPUT, and connect an LED to a pin, when calling `digitalWrite(HIGH)`, the LED may appear dim. This is because without explicitly setting a `pin-Mode()`, `digitalWrite()` will enable the internal pull-up resistor, which acts like a large current-limiting resistor.

e.g. LED, Buzzer	e.g. Press button control
<code>pinMode(pin,OUTPUT)</code>	<code>pinMode(pin,INPUT)</code>
<code>digitalWrite(pin,HIGH/LOW)</code>	<code>digitalRead(pin)</code>

Next :

```
delay(1000);
```

`delay()` pauses the program for the amount of time specified (in milliseconds). (There are 1000 milliseconds in 1 second.)

Hardware

Breadboard

Breadboard is a way of constructing and testing circuits without having to permanently solder them in place. Components are pushed into the sockets on the breadboard and then extra 'jumper' wires are used to make connections.

The breadboard has two columns, each with 17 strips of connections. In this diagram the black lines show how the top row is connected. This is the same for every other row. The two columns are isolated from one-another.

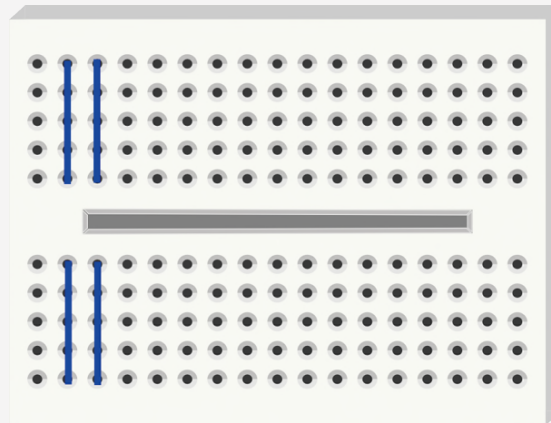

Fig 1-2 Breadboard Conductivity Direction

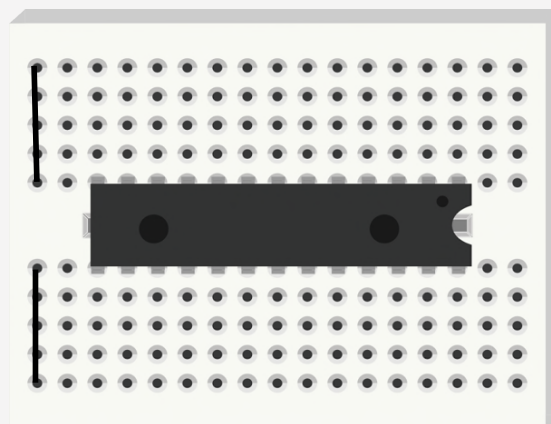

Fig 1-3 DIP Chip Inserted

Resistors

As the name suggests, resistors resist the flow of electricity. The higher the value of the resistor, the more resistance it has and the less electrical current will flow through it. The unit of resistance is called the **Ohm**, which is usually shortened to Ω (the Greek letter Omega).

Unlike LEDs, resistors are not polarized (do not have a positive and negative lead) - they can be connected either way around. Normally a LED needs 2V of voltage and 35 mA current to be lit, so with a resistor of 100Ω , you would be able to control the flow of electricity. If less than 100Ω , you might risk burning it out. Be careful of this because resistors can get **hot**!

If you want to read the resistance value from the resistor color code, visit this website for calculation tables: <http://www.21ic.com/tools/component/201003/54192.htm>

Read Resistor Color Rings

The resistor value will be marked on the outer package of your resistors, but what should we do in case the label gets lost and there are no measuring tools at hand? The answer is to read the resistor value. This is a group of colored rings around the resistor. Details are available online for those who are interested in having a try.

Here is an online calculator for five-color-ring resistor value calculating: <http://www.21ic.com/tools/component/201003/54192.htm>

LEDs

A light-emitting diode (LED) is a two-lead semiconductor light source. It is a basic pn-junction diode, which emits light when activated.

Typically, LEDs have two leads, one positive and one negative. There are two ways to tell which is the positive lead of the LED and which the negative: Firstly, the positive lead is longer. Secondly, where the negative lead enters the body of the LED, there is a flat edge to the case of the LED.

LEDs are **polarized**, so they have to be connected the right way around. If you put the negative lead of an LED in to the power supply and the positive lead to ground, the component will not work, as can be seen in the diagram to the right.

In your kit, you can also find LEDs with 4 leads. This is an RGB LED with 3 primary color LEDs embedded in to it. This will be explored later.

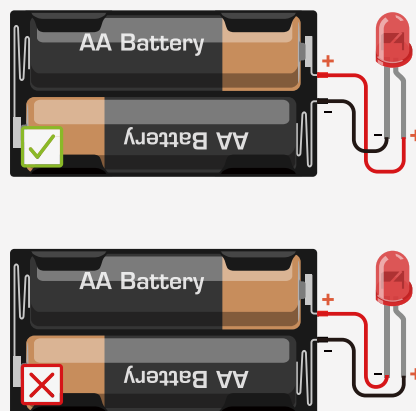

Project 2

S.O.S distress signal

02

Let's build a Morse code generator with the circuit we built in lesson 1. Morse code is a method of transmitting text information as a series of on-off tones, lights, or clicks. We can use a slow blink and quick blink of an LED instead of dots and dashes to indicate letters of the alphabet. For example, SOS. According to Morse code, "S" is represented with 3 dots which we can represent with a slow blink, while "O" is represented with 3 dashes which we can represent with a quick blink.

Sample code 2-1:

```
int ledPin = 10;
void setup() {
    pinMode(ledPin, OUTPUT);
}
void loop() {

    // 3 quick blinks to represent "S"
    digitalWrite(ledPin,HIGH);
    delay(150);
    digitalWrite(ledPin,LOW);
    delay(100);

    digitalWrite(ledPin,HIGH);
    delay(150);
    digitalWrite(ledPin,LOW);
    delay(100);

    digitalWrite(ledPin,HIGH);
    delay(150);
    digitalWrite(ledPin,LOW);
    delay(100);

    delay(100); //100 milliseconds as a break of each
letter
```

```
//3 quick blinks to represent "O"
digitalWrite(ledPin,HIGH);
delay(400);
digitalWrite(ledPin,LOW);
delay(100);

digitalWrite(ledPin,HIGH);
delay(400);
digitalWrite(ledPin,LOW);
delay(100);

digitalWrite(ledPin,HIGH);
delay(400);
digitalWrite(ledPin,LOW);
delay(100);

delay(100);
// 100 milliseconds delay between each letter

//3 quick blinks to represent "S" again
digitalWrite(ledPin,HIGH);
delay(150);
digitalWrite(ledPin,LOW);
delay(100);

digitalWrite(ledPin,HIGH);
delay(150);
digitalWrite(ledPin,LOW);
delay(100);

digitalWrite(ledPin,HIGH);
delay(150);
digitalWrite(ledPin,LOW);
delay(100);

delay(5000); // wait 5 seconds to repeat the
next S.O.S signal
}
```

CODE

It requires a lot of repetitive work to code like this. Is there a better way? Take a look at the following sample code.

Sample code 2-2:

```
//The second project -- S.O.S signal
int ledPin = 10;
void setup() {
    pinMode(ledPin, OUTPUT);
}
void loop() {
    //3 quick blinks to represent "S" again
    for(int x=0;x<3;x++){
        digitalWrite(ledPin,HIGH);           //configure LED on
        delay(150);                          //delay 150 milliseconds
        digitalWrite(ledPin,LOW);           //configure LED off
        delay(100);                          //delay 100 milliseconds
    }

    //100 milliseconds delay between of each letter
    delay(100);

    //3 quick blinks to represent "O"
    for(int x=0;x<3;x++){
        digitalWrite(ledPin,HIGH);           //configure LED on
        delay(400);                          //delay 400 milliseconds
        digitalWrite(ledPin,LOW);           //configure LED off
        delay(100);                          //delay 100 milliseconds
    }

    //100 milliseconds delay between of each letter
    delay(100);
```

```
// 3 quick blinks to represent "S" again
for(int x=0;x<3;x++){
    digitalWrite(ledPin,HIGH);           //configure LED on
    delay(150);                          // delay 150 milliseconds
    digitalWrite(ledPin,LOW);           //configure LED off
    delay(100);                          //delay 100 milliseconds
}

// wait 5 seconds to repeat the next S.O.S signal
delay(5000);
}
```

After uploading the code, you will see the LED blinking the S.O.S signal and repeating it after 5 seconds. If you were to put the circuit in to a water-proof case, you could use it for sailing or hiking!

CODE

The first part of the two sketches are identical: we have initialized a variable and configured digital pin 10 to carry out the output signal. In the main code loop(), you can find lines similar to the last project to turn the LED on and off. The difference here is that the main code contains 3 independent blocks of statements.

The first block is to output 3 dots.

```
for(int x=0;x<3;x++){
  digitalWrite(ledPin,HIGH); //configure LED on
  delay(150);                //delay 150 milliseconds
  digitalWrite(ledPin,LOW);  //configure LED off
  delay(100);                //delay 100 milliseconds
}
```

The "for" statement

The "for" statement is used to repeat a block of statements enclosed in brackets. An increment counter is usually used to increment and terminate the loop. The "for" statement is useful for any repetitive operation, and is often used in combination with arrays to operate on collections of data/pins.

There are three parts to the "for" loop header:

```
for(1 initialization ; 2 condition ; 4 increment) {
  3 statement ; }
}
```

So for the "for" statement in the sketch

```
for(int x=0;x<3;x++){
  .....
}
```

Step 1: Initialize value of variable x as 0

Step 2: Evaluate if x is less than 3.

Step 3: If it is valid, execute the following statement

Step 4: x increases and becomes 2.

Step 5: Repeat Step 2, now x=2, evaluate if it is less than 3.

Step 6: Repeat step 3

Until x=3, the condition of x<3 is not valid then the program skips over the code.

We set x<3 to have it repeat 3 times. Calculating from 0 to 2, it repeats 3 times.

If we wanted it to repeat 100 times, we can use the following code: `for(int x=0;x<100;x++){`

Some comparison operators like ">", "<" are frequently used in programming conditional statements. They will be covered in more detail in the next section.

Here are some common operators that you might use:

"<" is an example of a comparison operator. Comparison operators allow the Arduino to compare two values. Below are some more examples of frequently used comparison operators:

- == (equal)
- != (not equal)
- < (less than)
- > (greater than)
- <= (less than or equal)
- >= (greater than or equal)

Beware of accidentally using a single equals sign (e.g. if (x = 10)).

The single equals sign is the assignment operator, and sets x to 10 (puts the value 10 into the variable x). A double equals sign is comparison operator instead (e.g. if (x == 10)),

Also, be careful that there is no space between <= or >=.

You can also use arithmetic operators such as + - * / .

Now you should know how the "for" loop operates. There are 3 "for" loops in the code. The first "for" loop repeats 3 times and the long-lasting flashing alternates 3 times, giving an output of 3 "dots" representing the letter S in Morse code. The second "for" loop also repeats 3 times and the temporary flashing alternates 3 times, giving an output of 3 "dashes", representing the letter O in Morse code. The third "for" loop is identical to the first, and also outputs an S in Morse code.

You might notice there are various x variables in different blocks of code, but they don't interfere with each other. Because it has a limited scope in a specific block of function. It is the counterpart of global variables that needs to declare at the top of the code out of setup() and loop()function and you will be able to use it anywhere in the code.

Exercise

Let's make some traffic lights by using 3 digital pins to control 3 LED lights.

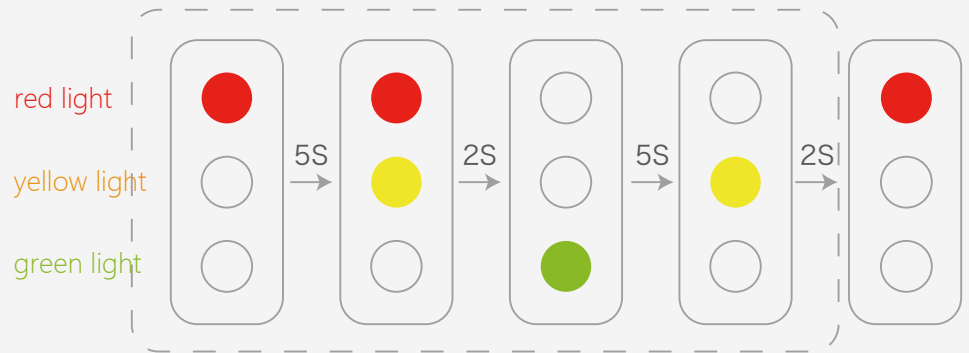

Project 3







Interactive traffic lights

03

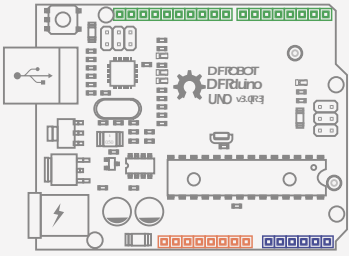
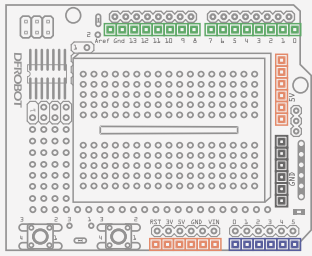
Interactive traffic lights

You will start your first interactive Arduino project in this lesson by making button-controlled traffic lights. When the button is pressed, the lights will change for pedestrians to pass by.

Required Components:

 <p>DFRduino UNO R3 x1</p>	 <p>Prototype Shield x1</p>	
 <p>Jumper Cables M/M x13</p>	 <p>Resistor 220R x6</p>	 <p>Pushbutton x1</p>
 <p>5MM LED x2</p>	 <p>5MM LED x2</p>	 <p>5MM LED x1</p>

*Why are there 5 LEDs with 6 resistors?

The extra resistor is a pull-down resistor for the button.

*After this, we won't list the Arduino, Breadboard, Prototype Shield or Jumpers in the component list any more as they will be necessary for every project.

Code

The sketch is originally from “Beginning Arduino”

Sample code 3-1:

```
// PROJECT 3 Interactive Traffic Light
int carRed = 12;    //configure traffic light
int carYellow = 11;
int carGreen = 10;
int button = 9;    //pin of button
int pedRed = 8;    //configure light for pedestrians
int pedGreen = 7;
int crossTime = 5000;    //time for pedestrians to pass unsigned
long changeTime;    //time that the button is pressed

void setup() {
    //configure all LEDs as output
    pinMode(carRed, OUTPUT);
    pinMode(carYellow, OUTPUT);
    pinMode(carGreen, OUTPUT);
    pinMode(pedRed, OUTPUT);
    pinMode(pedGreen, OUTPUT);
    pinMode(button, INPUT);    //configure button as input
    digitalWrite(carGreen, HIGH); //initialize green traffic
light on
    digitalWrite(pedRed, LOW); //initialize red pedestrian light off }

void loop() {
    int state = digitalRead(button);
    // test if the button is pressed and if 5 seconds have passed after it is pressed
lately.
    if(state == HIGH && (millis() - changeTime)> 5000){
        //carry out the function of changing LED
        changeLights();
    }
}

void changeLights() {
```

```

digitalWrite(carGreen, LOW); //green traffic light off
digitalWrite(carYellow, HIGH); //yellow traffic light on
delay(2000); //wait for 2 secs

digitalWrite(carYellow, LOW); // yellow traffic light off
digitalWrite(carRed, HIGH); //red traffic light on
delay(1000); // wait for 1 sec for safety reason

digitalWrite(pedRed, LOW); //red pedestrian light off
digitalWrite(pedGreen, HIGH); //light pedestrian light on

delay(crossTime); // time for crossing street

//blink green pedestrian light to notify pedestrians to pass soon
for (int x=0; x<10; x++) {
    digitalWrite(pedGreen, HIGH);
    delay(250);
    digitalWrite(pedGreen, LOW);
    delay(250);
}
digitalWrite(pedRed, HIGH); //red pedestrian light on
delay(500);

digitalWrite(carRed, LOW); //red traffic light off
digitalWrite(carYellow, HIGH); //yellow traffic light on
delay(1000);
delay(1000);
digitalWrite(carYellow, LOW); //yellow traffic light off
digitalWrite(carGreen, HIGH); //green traffic light on

changeTime = millis() // record the duration since last
change //back to the loop of main code
}

```

After uploading the sketch, take a look at how LED changes. First, the green traffic light is on and the red pedestrian light is on to allow cars to pass. Once you press the button, the pedestrian light changes from red to green and the traffic light changes from just green to green and red. There is then a delay allowing time for pedestrians to cross the street. When the delay comes to the end, the green pedestrian light blinks to notify pedestrians. When this finishes, the lights change back to the initial state with the green traffic light on and red pedestrian light on.

The above codes do look complex, but actually, it is not that difficult to understand the ideas in practice.

If you find it is difficult for you to follow, try to draw a diagram like the one in the homework of Project 2. This will help you to comprehend the codes a little better. Good luck!

Code

Based on the previous 2 projects, most of the codes should make sense for you. The codes start from a set of variable declarations, but we have used a new term. It is explained below:

unsigned long changeTime;

Before we use int to store integers from -32768 to 32767. The long command we use in this project can store integers from -2147483648 to 2147483647. Unsigned long cannot store negative numbers. So it stores integers from 0 to 4294967295.

If we use int, we might go over the limit of 32 seconds (32768ml sec) and risk having errors in running the sketch. As a result, we need another command to store integers and exclude negative numbers, such as unsigned long whose limit is 49 days.

Then we enter the setup() function to configure the LED and button.

pinMode(button, INPUT);

We have been quite familiar with pinMode() function introduced in Project 1. Its difference with LED project lies in that the button should be set as INPUT.

In setup() function, please initialize the pedestrian and traffic light:

```
digitalWrite(carGreen, HIGH); //initializing green traffic light on
digitalWrite(pedRed, LOW); //pedestrian red light on
```

The first line of the main sketch is to test the state of button in pin9.

int state = digitalRead(button);

Can the box of variable be infinite big?

Why can some variables store large amounts of data while some can't? It depends on storage space of the variable, a bit like a box. For example, the storage capacity of "int" is much smaller than "unsigned long".

Just like a computer has a limited storage space, a micro-controller, like your Arduino, is the same. The maximum storage space of Arduino UNO's main chip (Atmega328) is 32k, so if we can save some storage space, we should definitely do that.

Some common variables you will come across:

Data Type	RAM	Range
boolean	1 byte	0 ~ 1 (True or False)
char	1 byte	-128 ~ 127
unsigned char	1 byte	0~255
int	2 byte	-32768 ~ 32768
unsigned int	2 byte	0 ~ 65535
long	4 byte	-2147483648 ~ 2147483647
unsigned long	4 byte	0 ~ 4294967295
float	4 byte	-3.4028235E38 ~ 3.4028235E38
double	4 byte	-3.4028235E38 ~ 3.4028235E38

There are various type of variables. Int and long are for integers, char is for characters, float and double are for variables with decimal point.

Components

Push Button

The push button we used has 4 pins. When you press a button or flip a lever, they connect two pins together so that electricity can flow through them. Actually, there are only really two electrical connections; inside the switch package pins 1 and 4 are connected together, as are 2 and 3. The little tactile switches that are used in this lesson have four connections. You might have one with 2 pins, but it works the same way.

A push button can switch on and switch off the electricity flowing through the circuit. In the project, when it is pressed, D9 pin detects HIGH (on), otherwise it remains LOW (off).

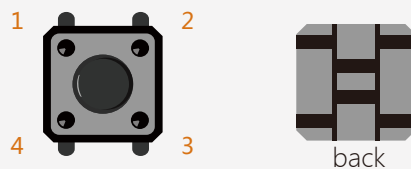

Fig 3-2 Structure of push button (front & back)

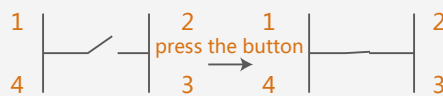

Fig 3-3 schematic diagram of push button

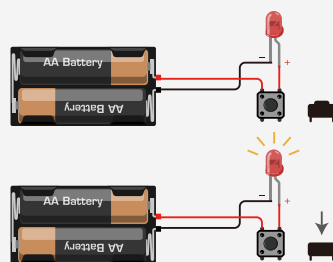
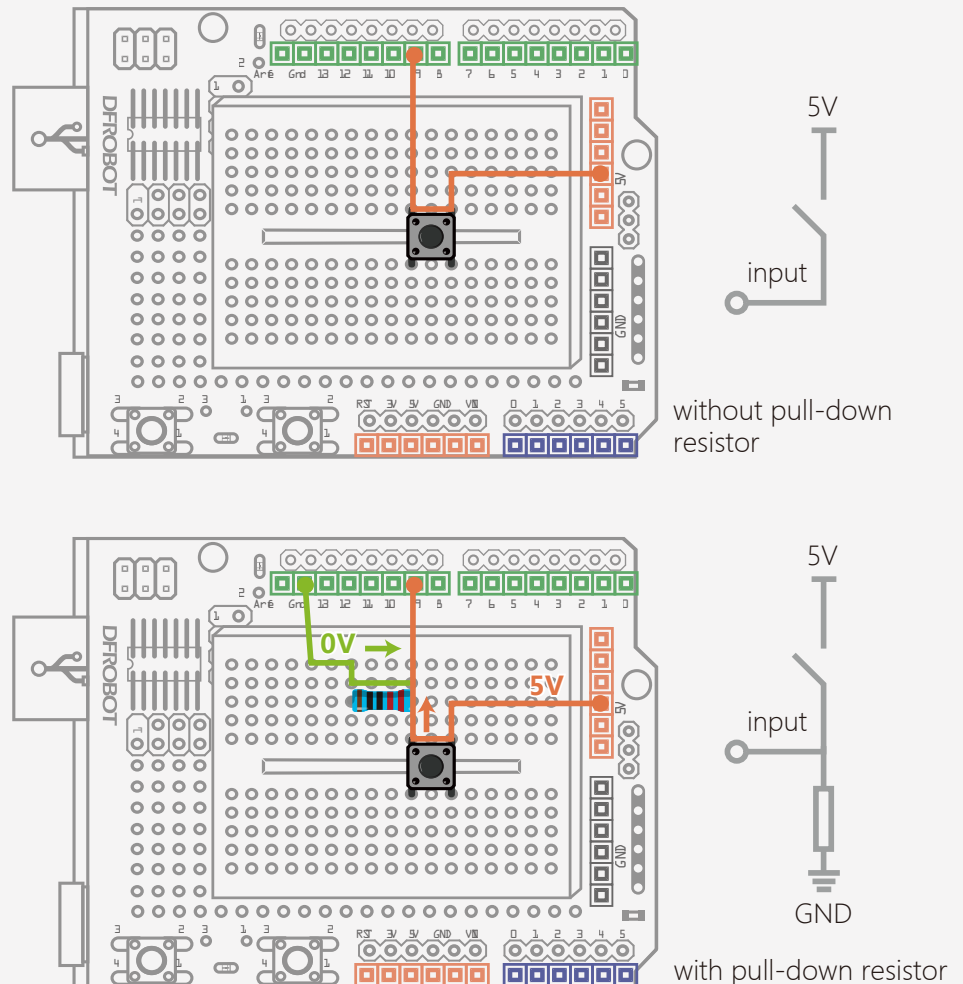

Fig 3-4 button diagram

What is pull-down resistor?

Pull-down resistors are used in electronic logic circuits to ensure that inputs to the arduino settle at expected logic levels if external devices are disconnected. A pull-down resistor weakly "pulls" the voltage of the wire it is connected to to ground when the other components on the line are inactive.

When the switch on the line is open, it has high impedance and acts like it is disconnected. Since the other components act as though they are disconnected, the circuit acts as though it is disconnected, and the pull-up resistor brings the wire up to the HIGH logic level. When another component on the line goes active, it will override the HIGH logic level set by the pull-up resistor. The pull-up resistor assures that the wire is at a defined logic level even if no active devices are connected to it.



Homework After Class

1. Choose 6 LEDs of any color and achieve the LED lights display.

Turn on the LED
Turn off the LED

2. When you are done, try to light up the column of LEDs in the middle and have them pass the light towards either edge.

3. Or light the column from left to right.

Project 4

Breathing LED

04

Breathing LED

In previous lessons, we learned how to turn a LED on and off by Arduino programming. It is also possible to control the brightness of your LED as well. There are 6 digital pins marked with "~" on your controller. This means that these pins can use a PWM signal. We will build a RGB LED fader by controlling PWM creating a smooth brightening and dimming of your LED as it gradually turns on and off.

Components

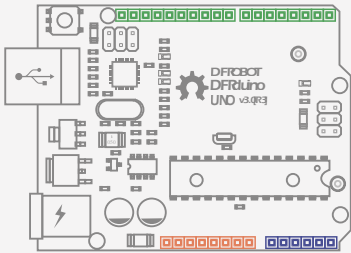

DFRduino UNO R3 x1

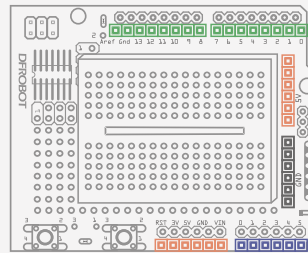

Prototype Shield x1



Jumper Cables
M/M x2



Resistor 220R x1



5MM LED x1

Circuit

The wiring diagram is the same as Project 1. If you are not clear about it, go back to Project 1 and have a look.

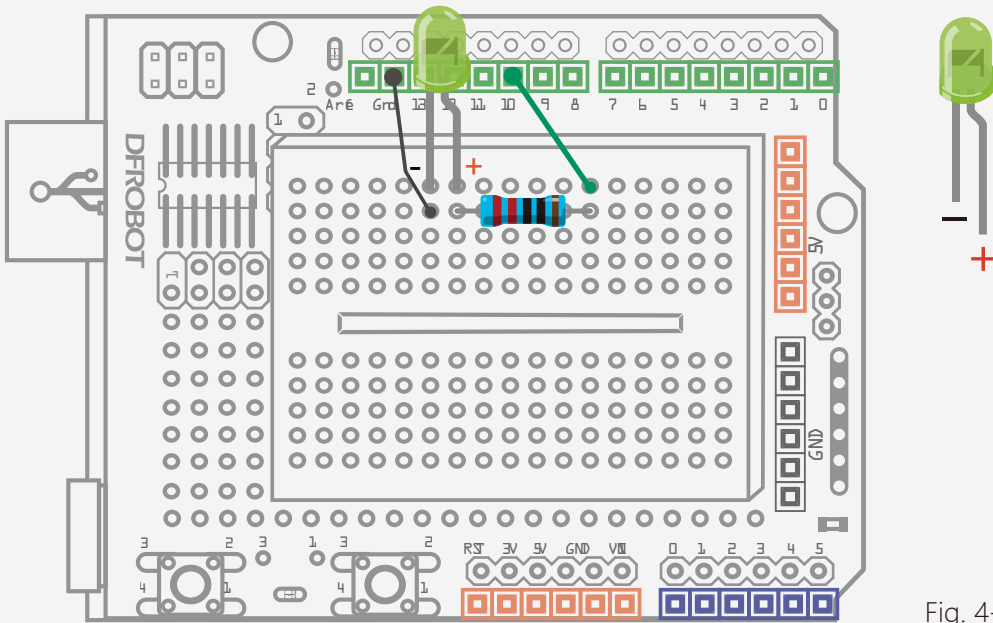

Fig. 4-1 Breathing LED Diagram

Arduino Code

Sample Code 4-1 :

```
// Project 4
int ledPin = 10;

void setup() {
  pinMode(ledPin,OUTPUT);
}

void loop(){
  fadeOn(1000,5);
  fadeOff(1000,5);
}

void fadeOn(unsigned int time,int increment){
  for (byte value = 0 ; value < 255; value+=increment){
    analogWrite(ledPin, value);
    delay(time/(255/5));
  }
}

void fadeOff(unsigned int time,int decreament){
  for (byte value = 255; value >0; value-=decreament){
    analogWrite(ledPin, value);
    delay(time/(255/5));
  }
}
```

You will see the LED getting brighter and fading constantly after uploading the code.

Code

Most of the code we are already very familiar with, such as initializing variable declarations, setting pins, setting up the "for" loop, as well as the function call.

In the main code, we only use 2 functions. You will have a clear idea after checking one of them as below.

```
void fadeOn(unsigned int time,int
increment){
    for (byte value = 0 ; value <
255; value+=increment){
        analogWrite(ledPin, value);
        delay(time/(255/5));
    }
}
```

The fadeOn() function has 2 parameters, "int time" for time and "int increment" for the increasing values. There is a for() statement that repeats the program. The condition is "value < 255" and the amount of brightness increase is decided by increment.

This is a new command in the "for()" function.

`analogWrite(ledPin, value)`

How can we send analog values to a digital pin? We use pins marked with a "~" on the end, such as D3, D5, D6, D9, D10 and D11, to output a variable amount of power to the LED. These technique of controlling power is known as "Pulse Width Modulation", or PWM for short.

The format of the analogWrite command is as below:

Value between 0 and 255

```
analogWrite( pin, value )
```

PWM pins

The "analogWrite()" function is to assign the PWM pin an analog value between 0 and 255.

Roughly every 1/500 of a second, the PWM pins outputs a pulse using digital signals. By controlling the length of on and off, it creates **an equivalent effect of carrying out** voltage between 0 volts and 5 volts. The length of pulse is called "pulse width" so PWM refers to pulse width modulation.

Let's take a closer look at PWM.

Pulse Width Modulation
0% Duty Cycle - analogWrite(0)



25% Duty Cycle - analogWrite(64)



50% Duty Cycle - analogWrite(127)



75% Duty Cycle - analogWrite(191)



100% Duty Cycle - analogWrite(255)



The green line is the cycle of the pulse. The percentage of length of high voltage and low voltage according to the value of analogWrite() function is known as the "Duty Cycle". The duty cycle of the first pulse is 0. So the value is 0 and the brightness of LED is 0, equivalent to off. The longer the signal is HIGH, the brighter the LED is. The duty cycle of the last pulse is 100%. So the value is 255 and the brightness of LED is 255. Likewise, 50% is half brightness and 25% is relatively dimmer.

PWM is widely used in controlling light brightness. We also use it to control the rotating speed of motors, such as wheels of vehicles powered by motors.

This chapter is over! Although we have used the same hardware as in Project 1, Arduino is running a different program, resulting in a completely different effect.

We think that the Arduino is amazing and we hope by now you do too!

Exercise

1. Create a flickering flame effect using LEDs by controlling the value of PWM at random. Cover it with paper and it will become a little lamp at night.

Materials:

1 x red LED

2 x yellow LED

1x 220 Ω resistor

Use the "`random()`" command to adjust the brightness level. We suggest you to initialize a brightness level first and let it change within a random value, such as `random(120)+135`. This way, the LED can change within a small amount just like a real flame!

You can look up to the references below for more explanations of various commands.

<https://www.arduino.cc/en/Reference/HomePage>

2. Try a more challenging project: Control the LED with 2 buttons, one to make it brighter, the other to make it dimmer.

Reference: <http://www.geek-workshop.com/thread-1054-1-1.html>

Project 5

Colour RGB LED

05

Color RGB LED

Let's start with a new component: an RGB LED. This component combines red, blue and green LEDs and can display various colors by adjusting the different values of each light. A computer monitor uses many RGB LEDs to display an image. We will learn how to create different colors with RGB LED randomly in the this lesson.

Components

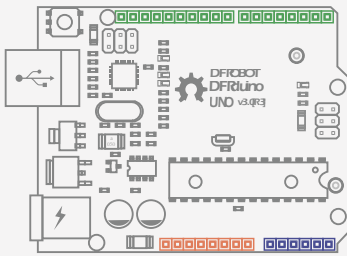

DFRduino UNO R3
x1

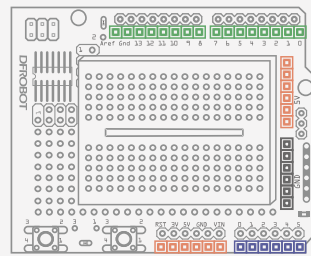

Prototype Shield
x1



Jumper Cables
M/M
x4



Resistor 220R
x3



5mm RGB LED
x1

Circuit

Before building the circuit, try to identify whether your RGB LED is common cathode or common anode. If you don't know how to do it, skip to the last part of this lesson. In this project, we assume that you are using a common cathode RGB LED.

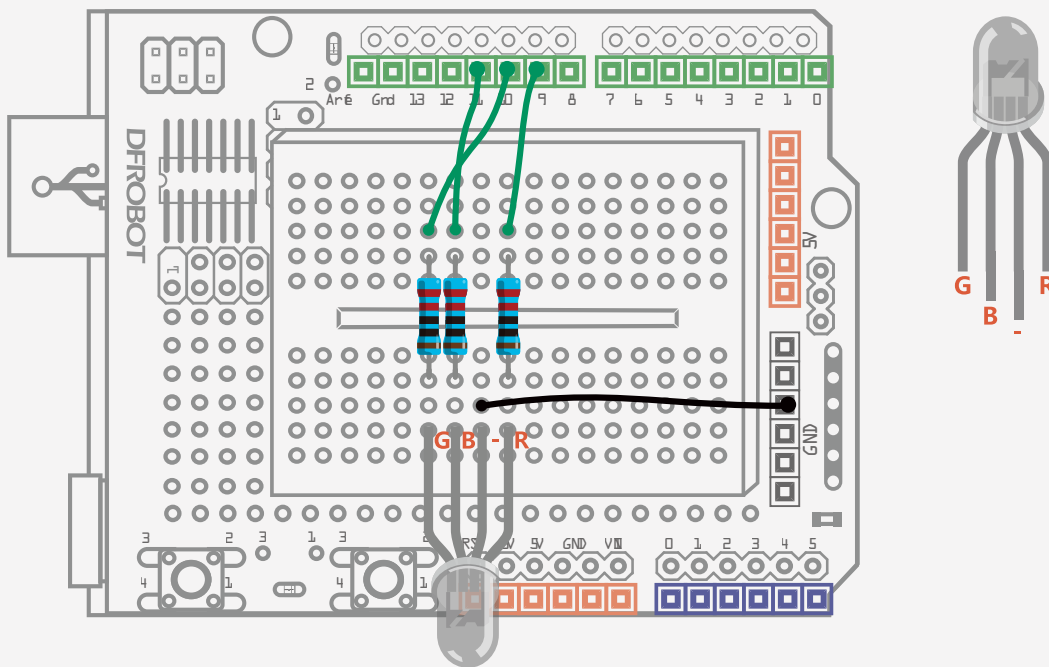

Fig. 5-1 Colourful RGB LED Diagram

Arduino Code

Sample code 5-1:

```
//PROJECT 5 RGB LED
int redPin = 9;
int greenPin = 10;
int bluePin = 11;

void setup(){
  pinMode(redPin, OUTPUT);
  pinMode(greenPin, OUTPUT);
  pinMode(bluePin, OUTPUT);
}

void loop(){
  //R:0-255 G:0-255 B:0-255
  colorRGB(random(0,255),random(0,255),random(0,255));
  delay(1000);
}

void colorRGB(int red, int green, int blue){
  analogWrite(redPin,constrain(red,0,255));
  analogWrite(greenPin,constrain(green,0,255));
  analogWrite(bluePin,constrain(blue,0,255));
}
```

You should see the RGB LED blinking with random colors after uploading this code.

Code

First, we will configure the 3 LEDs contained within the RGB LED to 3 PWM pins so we can adjust them to different colors by declaring 3 pins as an "OUTPUT".

The main part of this program is to create a new command: "colorRGB()" which has 3 parameters to assign a value to red, green and blue light between the values of 0 and 255.

This way, when we want to configure a color, we can simply assign values to this command instead of repeating the "analogWrite()" command constantly.

Here we will introduce "constrain()" and "random()". Do try to look them up with websites we mentioned in the last homework first and see if you can understand them.

The format of the constrain function is as follows:

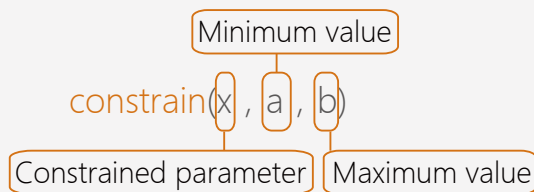

The "constrain()" function requires three parameters: x, a and b.

"x" is a constraint number here, "a" is the minimum, and "b" is the maximum.

If the value is less than "a", it will return to "a". If it is greater than "b", it will return to "b".

Red, green and blue are our constrained parameters. They are constrained between 0 and 255 (which falls into the range of PWM values). Values are generated at random using the "random()" function.

The format of "random()" is as below:

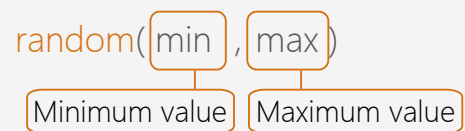

The first variable of this function is the minimum value and the second is the maximum. So we configure as "random(0,255)" in this program.

Components

RGB LED

The RGB LED has four leads. If you are using a common cathode RGB LED, there is one lead going to the positive connection of each of the single LEDs and a single lead that is connected to all three negative sides of the LEDs. That's why it is called common cathode. There is no difference in appearance between common cathode and common anode RGB LEDs, however, you do need to pay attention when assigning color values. For example, for the common cathode RGB LED, red is "R-255, G-0 B-0". For the common anode RGB LED, red is "R-0, G-255, B-255". How can we adjust the RGB LED to change to different colors?

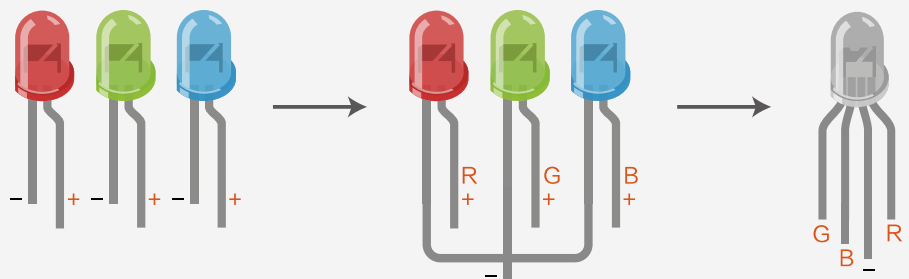

Fig. 5-2 How 3 LEDs form A RGB LED (Common Cathode)



Fig. 5-3 Remixing red, green and blue to achieve various colors

By assigning different values of brightness levels to 3 primary colors using the function "analogWrite(value)", you can configure any color you like!

You can configure 255x255x255 (16777216) kinds of colors by assigning different PWM values on these 3 LEDs!

Red	Green	Blue	Colour
255	0	0	Red
0	255	0	Green
0	0	255	Blue
255	255	0	Yellow
0	255	255	Blueish Green
255	0	255	Purplish Red
255	255	255	White

Fig. 5-1 Colours generated from combined PWM values of different LEDs

The difference between common anode and common cathode RGB LEDs

What is the difference between common anode and common cathode RGB LEDs in application? According to the figure below, there is no difference between common anode and common cathode in terms of their appearance. However, there are two key differences in their application:

- (1) Different connections: for the common anode, the common port should be connected to 5V but not GND, otherwise the LED fails to be lit.
- (2) Colour matching: the common anode RGB LED is totally different than the common cathode RGB LED. The common anode RGB LED decodes in the opposite way: "R-0, G-255 and B-255".



Fig. 5-4 Common Cathode RGB Diagram



Fig. 5-5 Common Anode RGB Diagram

Exercise

1. Based on the program above, create a color changing rainbow sequence. Try to configure various colors by playing with different values.

TIP: You only need to change variables of "colorRGB()".

2. Take your rainbow sequence LED and make each color fade so that the transition between each color is smoother.

How to load libraries

Download a library from the internet and unzip it to the "libraries" directory inside the Arduino IDE directory on your computer.

Beware that inside the folder will be a ".cpp" file, a ".h" file and often a "keywords.txt" file. Be sure that these are within the same directory otherwise the Arduino IDE will not recognize the library.

Then open the program in the example. Check whether you need to change the pins in the program if necessary.

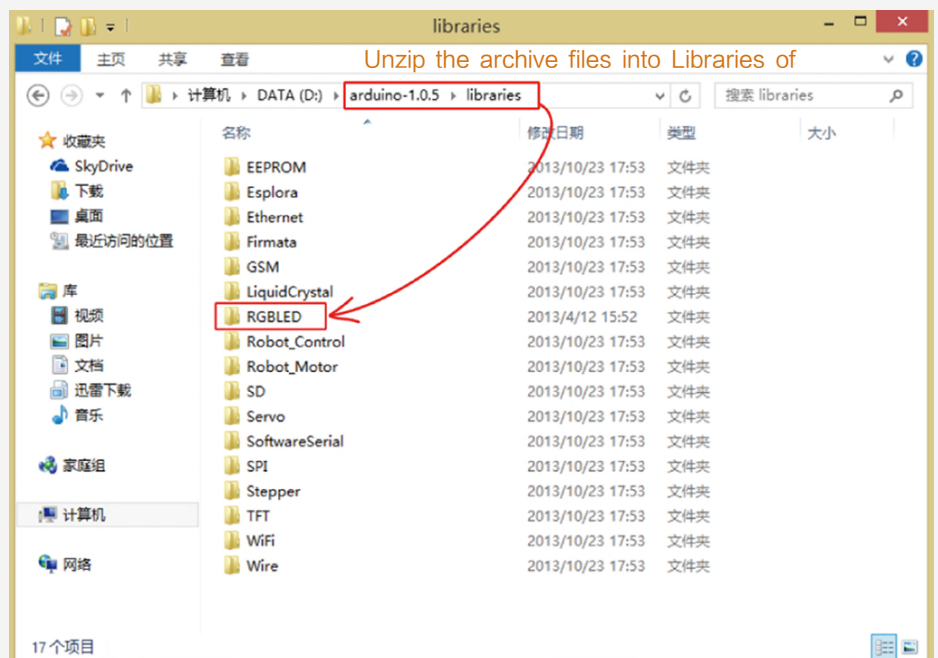

Project 6

Alarm

06

Alarm

Let's try a new component: the buzzer! It generates sounds of different frequencies using sinusoidal waves. If you connect a LED with the same sinusoidal wave, you can make your own alarm.

Component

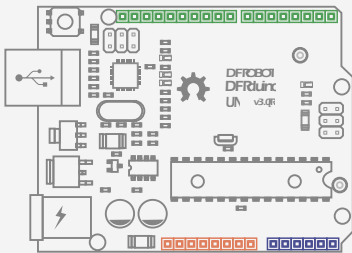

DFRduino UNO R3

x1

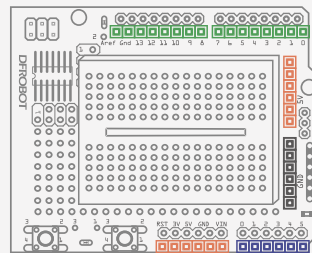

Prototype Shield

x1



Jumper Cables
M/M

x2



Buzzer

x1

Hardware Connections

Make the following connections. Notice that the longer leg on the buzzer is positive, and the shorter leg is negative. Connect the negative lead to GND and the positive lead to Pin 8.

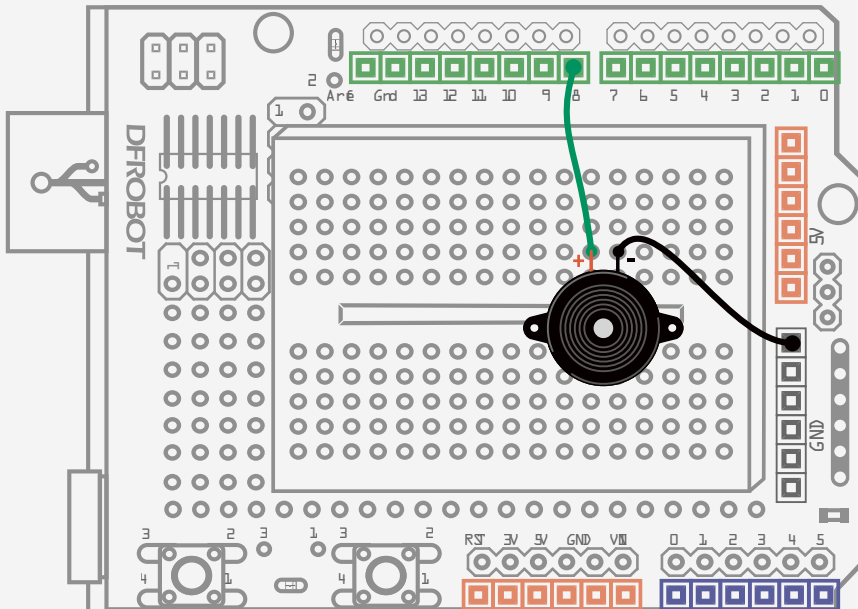

Fig. 6-1 Alarm Diagram

Code

Sample code 6-1 (from "Beginning Arduino")

Sample code 6-1:

```
// Project 6 Alarm
float sinVal;
int toneVal;

void setup(){
  pinMode(8, OUTPUT);
}

void loop(){
  for(int x=0; x<180; x++){
    //convert angle of sinusoidal to radian measure
    sinVal = (sin(x*(3.1412/180)));
    //generate sound of different frequencies by sinusoidal value
    toneVal = 2000+(int(sinVal*1000));
    //Set a frequency for Pin-out 8
    tone(8, toneVal);
    delay(2);
  }
}
```

You can hear alarm of high and low pitches after uploading the code.

Code

First, define two variables:

```
float sinVal;
int toneVal;
```

“float” is a datatype for floating point numbers (a number that has a decimal point).

Floating point numbers are often used to approximate analog and continuous values because they have greater resolution than integers. Here we use the “float” variable to store sinusoidal values. The sinusoidal wave changes quite evenly in a wave shape, so we convert it to sound frequencies. Hence, toneVal gets values from sinVal and converts it to frequencies.

```
for(int x=0; x<180; x++){
```

We need to use the formula “3.1412/180” to convert it from an angle to a radian value because the unit “sin” is radian instead of an angle.

```
sinVal=(sin(x*(3.1412/180)));
```

Then we change this value to a sound frequency of an alarm:

```
toneVal = 2000+(int(sin-
Val*1000));
```

“sinVal” is a floating variable, a value with decimal point. We don’t want our frequency to have decimal point, so we need to change the floating value to an integer value by writing the command as below:

```
int(sinVal*1000)
```

Human ears can notice sound of frequencies from 20Hz to 20kHz, so we multiply the raw value by 1000 times plus 2000 to assign the value for “toneVal” to give us a range of 2000 to 3000.

```
tone(8, toneVal);
```

Here we introduce 3 functions relevant to tone:

1. `tone(pin,frequency)`

“pin” is the digital pin connected to the buzzer. Frequency is the frequency value in Hz.

2. `tone(pin,frequency, duration)`

The “duration” parameter is measured in milliseconds. If there is no duration, the buzzer will keep making sound of different frequencies.

3. `noTone(pin)`

The “noTone(pin)” function is to end the sound from the specific pin.

Components

The Buzzer

A buzzer is an electronic component that can generate sound. There are generally two types: piezo buzzers and magnetic buzzers.

The Difference between Active Buzzers and Passive Buzzers

Piezo and magnetic buzzers are further categorized into two types: active and passive buzzers. The basic difference lies in different demands for their input signal. In this case, "active" and "passive" do not refer to power sources, but oscillation sources.

An active buzzer has its own oscillation source - it buzzes as it is powered on.

An active buzzer has a simple oscillator circuit that changes DC current into a pulse signal of a certain frequency. Active buzzers contain a special film called "molybdenum" the magnetic field from the oscillation of the buzzer. Once powered, it starts to make a sound.

Active buzzers are non-polarized meaning that you can connect them any way around and they will work.

In this kit, active magnetic buzzers are included.

A passive buzzer has no oscillator of its own, so it needs to use a square wave from 2kHz to 5kHz to trigger it instead of simply using direct current.

Passive buzzers are polarized, so they have to be connected the correct way around: They have a long lead (anode) and short lead (cathode)

For a beginner, passive buzzers are easier to work with.

If you want to explore buzzers further, here are some project ideas:

Passive buzzers are good for various musical effects.

There are many applications based on buzzers. A lot of buzzer-based gadgets are possible like infrared sensors and ultrasonic sensors for monitoring and alerting approaching objects; temperature sensors for excess temperature alarm; gas sensors for gas leakage alarms. Besides alarms, buzzers can also be used as musical instruments using different frequencies to form different notes.

Aren't buzzers amazing?

Exercise

1. Make an alarm with a red LED.

Set up your circuit so that the LED changes in in unison with the "sin" function so that the light intensity changes with the sound.

2. Using what you learned in Project 3, can you make a door bell? When the button is pressed, the buzzer should make a sound.

Project 7

Temperature Alarm

07

Temperature Alarm

We added a temperature sensor to the previous circuit to trigger the buzzer to make a sound when the temperature reaches a certain range. This is our first project using an actuator responding to a sensor.

Component

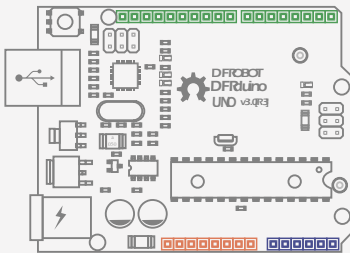

DFRduino UNO R3

x1

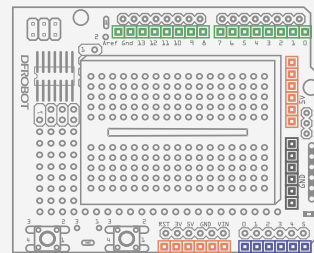

Prototype Shield

x1



Jumper Cables
M/M

x5



Buzzer

x1



Tem. Sensor

x1

Sample code 7-1:

```
//Project 7 Temperature Alarm
float sinVal;
int toneVal;
unsigned long tepTimer ;

void setup(){
  pinMode(8, OUTPUT);          // configure pin of buzzer
  Serial.begin(9600);          // configure baud rate to 9600 bps
}
void loop(){
  int val;                      //save the value of LM35
  double data;                  // save the converted value of temperature
  val=analogRead(0);           //Connect LM35 to analog pin and read
value from it
  data = (double) val * (5/10.24); //Convert the voltage value to
temperature value

  if(data>27){ //If temperature is higher than 27, the buzzer starts to
make sound.
    for(int x=0; x<180; x++){
      //Convert sin function to radian
      sinVal = (sin(x*(3.1412/180)));
      //Use sin function to generate frequency of sound
      toneVal = 2000+(int(sinVal*1000));
      //Configure the buzzer pin 8
      tone(8, toneVal);
      delay(2);
    }
  } else {                      // If the temperature is lower than
27, turn off the buzzer
    noTone(8);                  // Turn off the buzzer
  }
  if(millis() - tepTimer > 50 // Every 50 ms, serial port outputs
temperature value.
    tepTimer = millis();
    Serial.print("temperature: "); // Serial port outputs temperature
    Serial.print(data);           // Serial port outputs temperature
value
    Serial.println("C");          // Serial port output temperature
unit
  }
}
```

After the code is successfully uploaded, open the serial monitor of Arduino IDE.

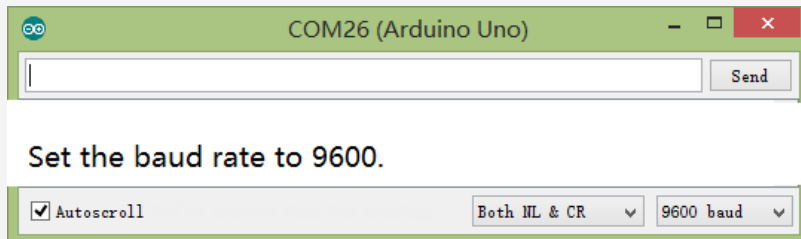

Read temperature value from the serial port. If you put your fingers on the LM35 sensor, you will find the temperature rises immediately. Your fingers are transferring heat to the sensor!

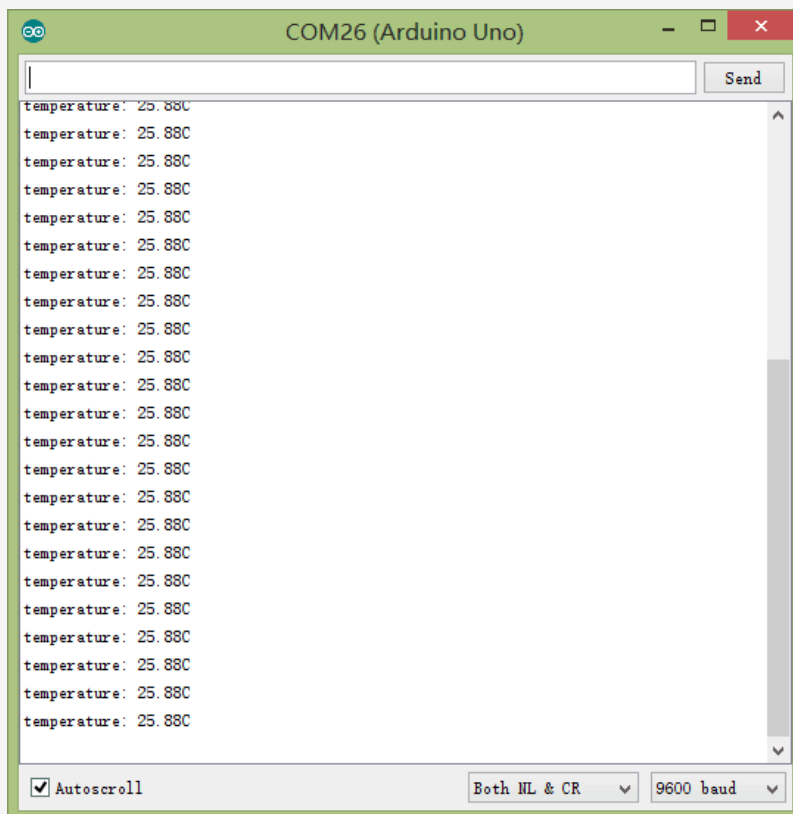

As per the program, once the temperature reaches 27 degrees C, the buzzer starts to sound. If the temperature drops below 27 degrees C, the buzzer stops.

Most of the above codes are the same as those in Project 6. Almost all of the syntax has been mentioned in previous projects. Hopefully you have some understanding about the variables and functions by now.

We initialize 3 variables at the top of the program.

```
float sinVal;
int toneVal;
unsigned long tepTimer ;
```

The third variable "tepTimer" is an unsigned long datatype to store time and output temperature values from serial port.

Why "unsigned long"?

Since the machine will run for a relatively long time, we choose a long integer and since it cannot store negative numbers, it is unsigned.

In the first line of the "setup()" function, why do we only configure the buzzer as output mode and disregard the LM35 temperature sensor?

The LM35 uses analog values.

Analog values don't need to be configured for "pinmode". "pinMode" is only used for digital pins.

There are many functions for serial port communication:

```
Serial.begin(9600);
```

This function is to initialize the baud rate (data transmit rate) of the serial port. Normally the default setting in the serial monitor works for most applications, but some wireless modules have a specific baud rate requirement.

In the "loop()" function, we declare 2 variables: "val" and "data" at the top. These are variables in a limited scope so that they only run inside the individual block of code.

```
val=analogRead(0);
```

This is a new function, "analogRead (pin)".

```
analogRead(pin)
```

This function reads a value from the specified analog pin. The digital pins in the Arduino are connected to a 10 bit analog to digital converter, so the voltage between 0 and 5V is converted to a value ranging between 0 and 1023. Each value corresponds to a value of voltage. The voltage value of temperature read here outputs a range between 0 to 1023. Every 10mV corresponds to 1 degree for LM35 temperature sensor.

```
data = (double) val *
(5/10.24);
```

From the voltage value read via the sensor, the range is from 0 to 1023. So we divide it into 1024 parts and multiply the result by 5 to convert it to voltage value. Since 10mV corresponds to 1 degree, we need to multiply that to get a temperature value in double datatype and assign it to a data variable.

The Serial Port The serial port allows the Arduino to communicate with the external world by transmitting and receiving data. There is at least one serial port in each Arduino micro-controller, separately connected to digital pin 0 (RX/data receive) and analog pin 1 (TX/data transmit). Digital pin 1 and 0 cannot be used for I/O function when the serial port is in use. You download code to the Arduino via the serial port. When downloading code, the USB will occupy digital pin RX and analog pin TX. The RX and TX pins can not receive other signals during this, or there will be interference. The best way to use these 2 pins is to insert components after downloading your code.

In the following program, we evaluate the condition by using the "if/else" statement.

The "if/else" statement format:

```
if (expression) {
  Statement 1;
} else{
  Statement 2;
}
```

This function is known as a conditional. It works as follows:

An expression is specified. If the conditions of the expression are true, statement 1 is executed and statement 2 is skipped.

If the expression is false, statement 2 is executed and statement 1 is skipped.

Either statement 1 or 2 is to be executed but simultaneous execution is prevented. Put in simple terms, this is the Arduino making a decision between two predetermined variables.

```
if(data>27){          for(int
  x=0; x<180; x++){
  .....
}
} else {
  ..... }
```

If the temperature is higher than 27, The program runs the first part of the program, following the if statement to activate the buzzer. If not, it runs the else statement to stop the buzzer.

Apart from detecting temperature change for our alarm, we also need to display the temperature the Arduino reads via the serial port. We need to use the "millis()" function again to send out data every 500ms. (See Project 3 for more details if you are unsure.)

After the serial port has received data, how can we display it on the serial monitor?

```
Serial.print(val);
Serial.println(val);
```

`print()` works to convert "val" to a readable ASCII format (standard text) output from the serial port.

There are various formats for this function:

1. numbers output as a number

e.g.: `Serial.print(78);` outputs "78"

2. floating datatype outputs as floating number with maximum 2 digits after decimal point

e.g. `Serial.print(1.23456);` outputs "1.23"

3. Add single quotation mark to character and add double quotation mark to character string.

e.g. `Serial.print('N');` outputs "N"

```
Serial.print("Hello world.");
outputs "Hello world."
```

The difference between "println()" and "print()" is that "println()" has a new line character.

Another common command is "Serial.write()". It does not output in ASCII format but in a byte format. Check the reference on Arduino.cc if you are interested in finding out more.

```
Serial.print(data);
```

Is data a character string?

Why does it output numbers?

The answer is because we declared the variable in the program setup function to assign a number to it.

Components

LM35 temperature sensor

The LM35 is a very common temperature sensor which is accurate to $+0.25^{\circ}\text{C}$.

It has 3 pins:

"+Vs" is power

"Vout" is voltage output

"GND" is ground.

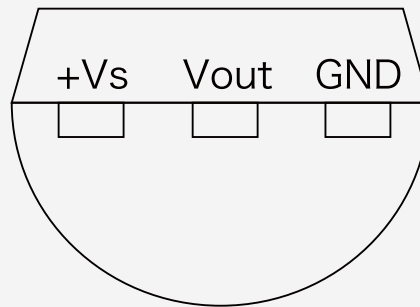

Diagram of LM35 pins

The calculation formula is as follows:

$$V_{out} = 10\text{mV}/^{\circ}\text{C} * T^{\circ}\text{C} \text{ (Temperature range } +2^{\circ}\text{C} \sim 40^{\circ}\text{C} \text{)}$$

If you want to learn more about this component, you can consult the data sheet. This gives extra detail on how a method for converting temperature data into voltage.

A useful resource for component datasheets can be found here:

<http://www.alldatasheet.com/>

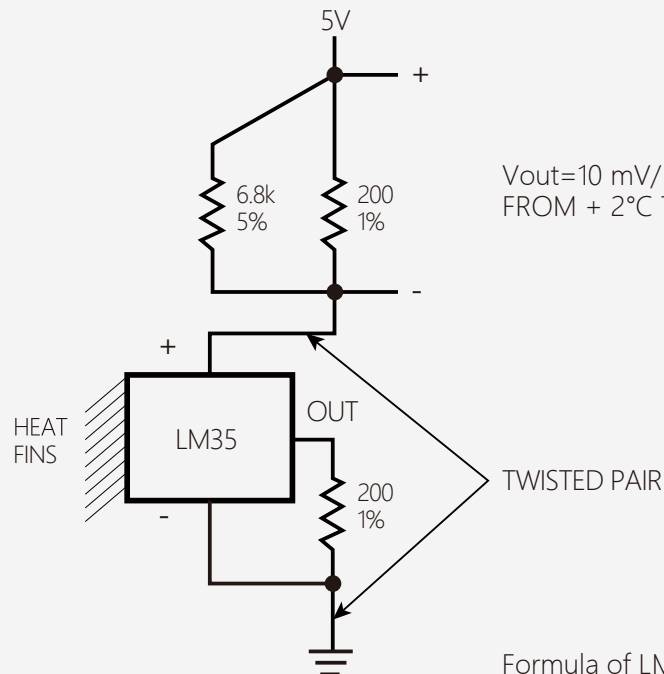

$$V_{out} = 10 \text{ mV}/^{\circ}\text{C} (\text{TAMBIENT} + 1^{\circ}\text{C})$$

FROM $+ 2^{\circ}\text{C}$ TO $+ 40^{\circ}\text{C}$

Formula of LM35

Exercise

Add a LED to the project above. When the temperature is in a defined range, make the LED turn on and make the buzzer sound.

You can assign different colored LEDs and different buzzer sounds for different temperature ranges

E.g.:

- When the temperature is lower than 10 or higher than 35, a red LED turns on and the buzzer makes a rapidly-oscillating sound
- When the temperature falls between 25 and 35, a yellow LED turns on and buzzer makes a smooth-oscillating sound
- When the temperature falls between 10 and 25, a green LED turns on and the buzzer is off.

Project 8

Vibration Sensor

08

Vibration Sensor

In this project we are going to use the tilt sensor included in your kit. The tilt sensor can detect basic motion and orientation. It contains two contacts and a small metal ball. Once held at a particular orientation, the ball bridges the two contacts and completes the circuit. We have also added an LED to this project. When the sensor detects movement, the LED is HIGH (on). When no movement is detected the LED is LOW (off).

Component

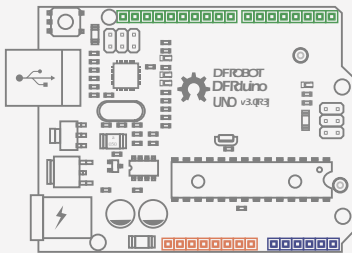

DFRduino UNO R3

x1

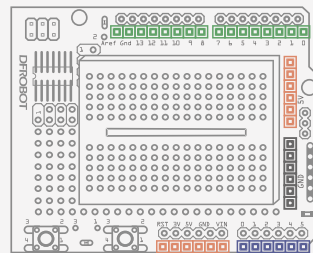

Prototype Shield

x1



Jumper Cables
M/M

x5



5MM LED

x1



Resistor 220R

x2



Tilt Switch Sensor

x1

Circuit

A tilt sensor behaves much like a push button. You need to add a pull-down resistor to the sensor to ensure the circuit is disconnected when no signal is detected.

You also need to add a current-limiting resistor to the LED.

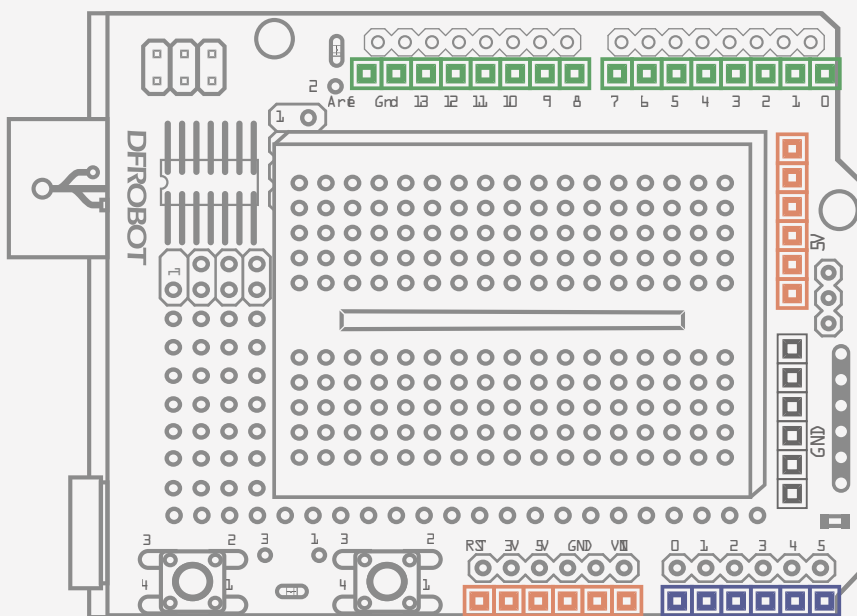

Diagram of the tilt sensor circuit

Code

Sample code 8-1

```
//project 8 – Vibration sensor

int SensorLED = 13;           //define LED digital pin 13
int SensorINPUT = 3;         // connect tilt sensor to interrupt 1 in
digital pin 3
unsigned char state = 0;

void setup() {
  pinMode(SensorLED, OUTPUT); //configure LED as output mode
  pinMode(SensorINPUT, INPUT); //configure tilt sensor as input mode
  //when low voltage changes to high voltage, it triggers interrupt 1 and runs
  the blink function
  attachInterrupt(1, blink, RISING);
}

void loop(){
  if(state!=0){              // if state is not 0
    state = 0;                // assign state value 0
    digitalWrite(SensorLED,HIGH); // turn on LED
    delay(500);               // delay for 500ms
  }
  else{
    digitalWrite(SensorLED,LOW); // if not, turn off LED
  }
}

void blink(){                // interrupt function blink()
state++;                     //once trigger the interrupt, the state
keeps increment
}
```

Expected behaviour:

When we shake the board, the LED is HIGH (on). When we stop shaking, the LED is LOW (off).

Code

In this section we are going to examine the “interrupt” function that we used in the code. The program works as follows: when there is no interruption to the program, the code keeps running and the LED stays LOW (off). When there is an external event and the tilt sensor is activated, such as someone shaking the board, the program runs the “blink()” function and “state” starts incrementing. When the “if” statement detects that the state is no longer 0, it triggers the LED to be HIGH (on). At the same time, it resets “state” to 0 and waits for the next interruption. If there is no interruption, the LED is LOW (off).

What is interruption?

Imagine you are watching TV at home and the phone rings. You have to stop watching TV and pick up the phone. After the call has ended, you continue to watch TV. In this case, the call is the **interrupt** and the ringing of the phone is the **condition**.

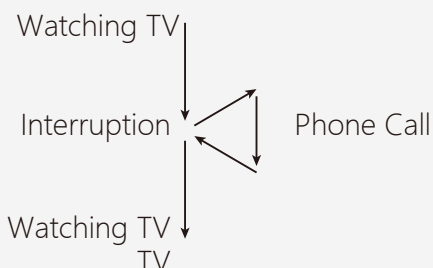

The “attachInterrupt” function specifies a named function, or an “Interrupt Service Routine” (ISR), to call upon when an interrupt occurs. This replaces any previous function that was attached to the interrupt. Most Arduino boards have two external interrupts: numbers 0 (on digital pin 2) and 1 (on digital pin 3). Different boards have different interrupt pins.

Check the references on arduino.cc for details: <http://arduino.cc/en/Reference/AttachInterrupt>

There are 3 parameters in “attachInterrupt”

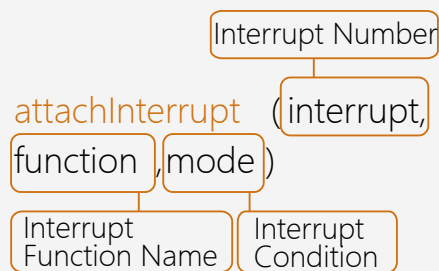

“interrupt”:

The number of the interrupt (int), is either number 0 or 1. If it is 0, you must connect the jumper wire to digital pin 2. If it is 1, you must connect the jumper wire to digital pin 3.

“function”:

- The function is called upon when the interrupt occurs
- The function has no parameters and returns nothing.
- As “delay()” and “millis()” both rely on interrupts, they will not work while the function is running.
- The function cannot read values from the serial port. You might lose data connected from serial port.

“mode”:

“mode” defines when the interrupt should be triggered. Four constants are predefined as valid values: “LOW” to trigger the interrupt whenever the pin is low, “CHANGE” to trigger the interrupt whenever the pin changes value “RISING” to trigger when the pin goes from LOW to HIGH, “FALLING” for when the pin goes from HIGH to LOW.

Now let’s go back to the program:

```
attachInterrupt(1, blink, RISING);
```

- “attachInterrupt(1,” because the tilt sensor is connected to digital pin 3.
- “Blink” is our interrupt function
- “RISING”, to trigger when the pin goes from LOW to HIGH.

Why have we chosen “RISING”? When the tilt sensor does not detect any signal, pin 3 is LOW. When it detects a signal, it connects with 5 volts and this change the pin from LOW to HIGH.

Components

Tilt Sensor

The tilt sensor goes by many different names: ball switch, bead switch, vibration switch, etc. Though it has different names, its working principles are the same. In simple terms, it is a switch made up of a cylinder with a small metal ball inside. When the metal ball rolls to either edge of the cylinder, it touches one of the contact pins and the circuit is complete. Examine the diagram for further detail.

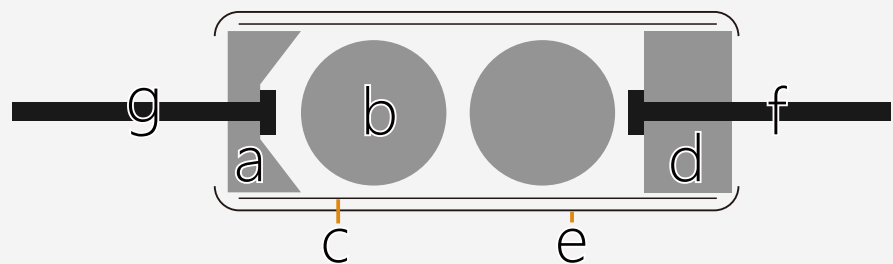

- | | | |
|-------------------------------|-------------------------|----------------|
| a. Bronze Cover | b. Bronze Bead | c. Bronze Pipe |
| d. PC set | e. Heat-shrinkable Pipe | |
| f. Bronze Conductive Pin | | |
| g. Phosphor Copper Pinch Cock | | |

Fig. 8-2 Vibration Sensor Diagram

Project 9

Light Sensitive LED







09

Light Sensitive LED

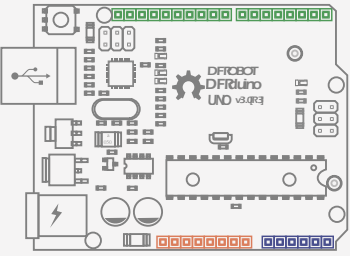
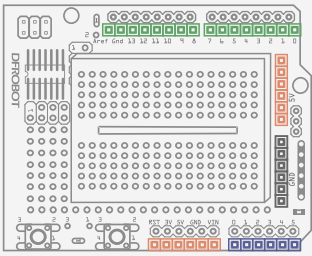
Let's introduce a new sensor component: the photo diode. In simple terms, when the sensor detects light, its resistance changes. The stronger light in the surrounding environment, the lower the resistance value the photo diode will read. By reading the photo diode's resistance value, we can work out the ambient lighting in an environment. The photo diode provided in the starter kit is a typical light sensor.

In this project, we will make an automatic light that can adjust itself according to the ambient lighting around it. When it is dark, the photo diode detects the change and triggers the light, and vice versa.

Components

 <p>DFRduino UNO R3 x1</p>	 <p>Prototype Shield x1</p>	
 <p>Jumper Cables M/M x5</p>	 <p>5MM LED x1</p>	 <p>Ambient Light Sensor x1</p>
 <p>Resistor 220R x1</p>	 <p>Resistor 10K x1</p>	

Circuit

Be aware that photo diodes are polarized, just like LEDs, so they will only work if connected the correct way around.

The photo diode has to be connected with a 10k resistor rather than a 220Ω resistor

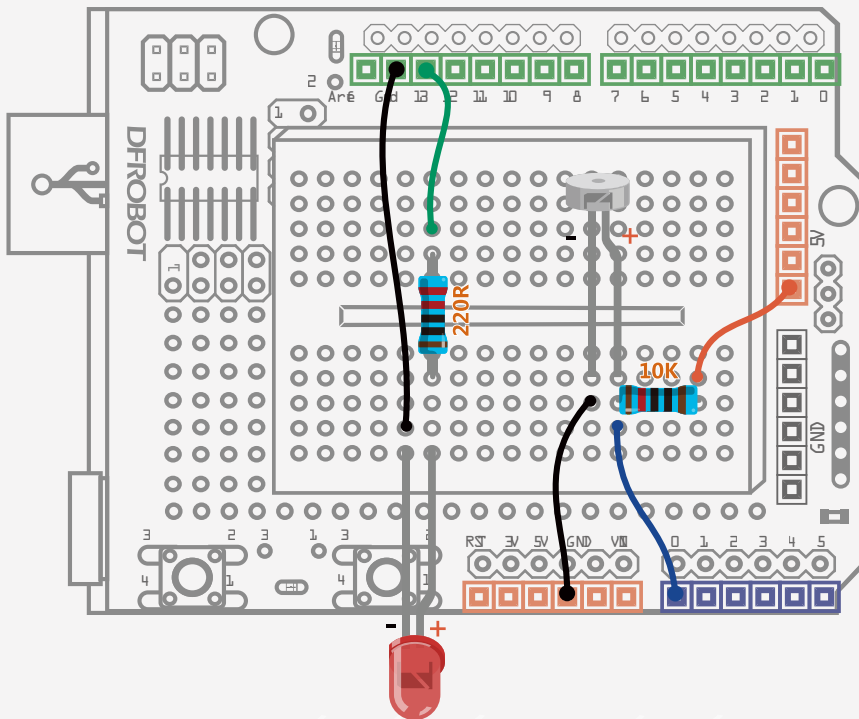

Diagram of the photo diode circuit

Sample code 9-1 :

```
// Project 9- Light the lamp
int LED = 13;           //define LED digital pin 13
int val = 0;           //define the voltage value of photo diode in
digital pin 0
void setup(){
  pinMode(LED,OUTPUT); // Configure LED as output mode
  Serial.begin(9600);  //Configure baud rate 9600
}

void loop(){
  val = analogRead(A0); // Read voltage value ranging from 0 -1023
  Serial.println(val);  // read voltage value from serial monitor
  if(val<1000){        // If lower than 1000, turn off LED
    digitalWrite(LED,LOW);
  }else{               // Otherwise turn on LED
    digitalWrite(LED,HIGH);
  }
  delay(10);          // delay for 10ms
}
```

After uploading the code, you can shine a flashlight on the photodiode to alter the light levels in the environment. When it is dark, the LED should light up. When it is bright, the LED should turn off.

Code

A very brief explanation of the program:

Similar to the LM35 temperature sensor, the photo diode reads an analog signal so we don't need to define "pinMode" in "serial.begin".

We take the analog current data from the photodiode and compare it to a value of 1024 to make it digital. You can change this value if you like. Try playing with the serial monitor and seeing what outputs the photodiode gives. Then use this number you get here as the comparison number to alter the sensitivity of the circuit.

Circuit

Photo Diode

A photo diode is a semiconductor device that converts light into current. The current is generated when photons are absorbed in the photo diode. The stronger the environment's light, the lower the resistance value the photodiode will output. The analog value ranging from 0 to 1023 corresponds to voltage value ranging from 0 to 5V.

The input voltage V_{in} (5V) is connected to 2 resistors. By measuring the voltage of R2 as below, you can get the resistance value of photo diode.

In our project, R1 is the 10k resistor and R2 is the photo diode. The resistance value of R2 in dark is so high that it almost reaches 5V. Once photons are absorbed, the value of R2 will decrease, and so will its voltage value. For this project it is preferable to use a fixed resistor ranging from 1k to 10k, otherwise the voltage dividing ratio is not obvious. This is why in this project we have used a 10k resistor for R1.

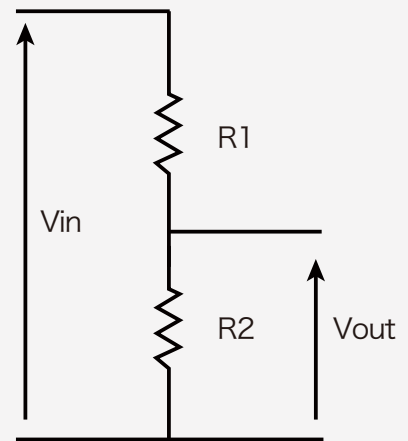

Diagram of voltage divider

$$V_{out} = \frac{R2}{R1+R2} \times V_{in}$$

Formula of voltage divider

Project 10

How to Drive A Servo

10

How to Drive A Servo

Servos are ideal for embedded electronics applications because they can move to a specific position accurately. Most servos can turn 180 degrees at maximum. Some even larger ones can turn to 360 degrees. They can be used in mobile platforms for detection devices such as cameras and detectors of smart vehicles, or in robotic joints.

Component

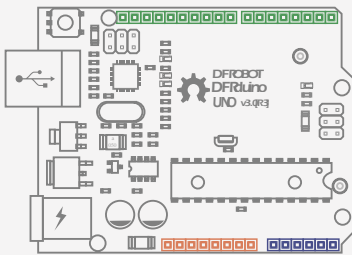

DFRduino UNO R3

x1



Jumper Cables
M/M

x3



Servo

x1

Circuit

The servo has three leads. The color of the leads varies between servos but the red lead is always 5V and GND will either be black or brown. The other lead is the signal lead and this is usually orange or yellow. This signal lead is connected to digital pin 9.

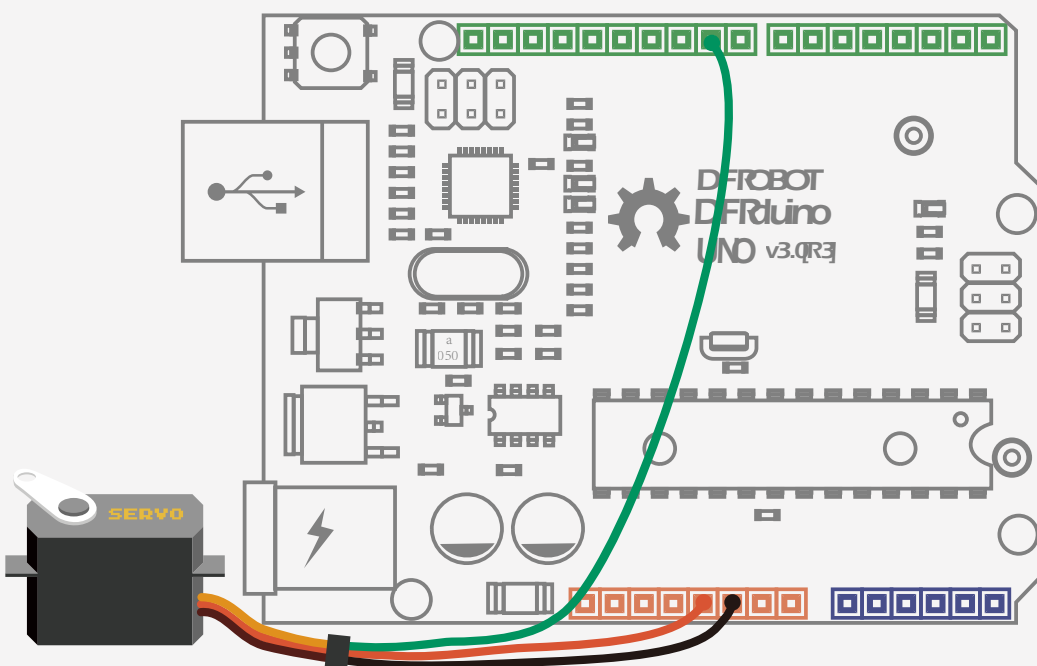

Circuit diagram of a servo connected to an Arduino

Code

Sample Code 10-1

```
//Project 10 Servo
#include <Servo.h>           //declare to insert Servo.h library
Servo myservo;              //create servo object to control a servo
int pos = 0;                //variable pos to store position of servo
void setup() {
  myservo.attach(9);        //attach the servo to digital pin 9.
}

void loop() {
  for(pos = 0; pos < 180; pos += 1){ //servo turns from 0 to 180 in steps
of 1 degree
    myservo.write(pos); //tell servo to go to position in variable 'pos'
    delay(15);           //wts 15ms for the servo to reach the position
  }
  for(pos = 180; pos >= 1; pos -= 1) { // servo turns from 180 to 0 in steps
of 1 degree
    myservo.write(pos); //tell servo to go to position in variable 'pos'
    delay(15);           //waits 15ms for the servo to reach the position
  }
}
```

After uploading the sketch, you will see servo sweeping back and forth from 0 to 180 degrees.

Code

The sketch starts from inserting <Servo.h > library.

```
#include <Servo.h>
```

This library is already in Arduino IDE. Identify it by opening Arduino-1.0.5/ libraries/ Servo/ Servo.h.

Libraries are collections of new commands that have been packaged together to make it easy to include them in your sketches. Arduino comes with a handful of useful libraries, such as the servo library used in this example that can be used to interface to more advanced devices.

We need to create a name in the code for the servo:

```
Servo myservo; // create
servo object to control
a servo
```

There is another command in the "setup()" function.

```
myservo.attach(9);
```

Declaring functions in the servo library is a bit different from declaring other functions. We need to declare various functions in the library including declaring the servo object and defining the function. Just like in the library, you need to point out the object so that the program can identify it. The format of library function is as below.

Don't miss the dot sign(".") in between the word "my servo" and "attach". "myservo" is the servo object we named before. So the function we invoke is:

```
attach(pin) ;
```



"attach(pin)" assigns the pin. We can use any digital pin, except 0 and 1. In this project, we have chosen digital pin 9.

In the main program, there are 2 "for" statements. The first one starts from 0 then spins to 180 degrees in 1 degree increments. The second one starts from 180 degrees and goes back to 0 in 1 degree increments.

```
myservo.write(pos);
```

Just like the previous command, you have to declare a name for this command. The parameters of this function is an angle. The unit is degrees.

If you want to know more about the functions in the servo library, visit the arduino website:

<http://arduino.cc/en/reference/servo>

or visit the DFRobot website:

www.dfrobot.com

Project 11

Controllable Servo

11

Controllable Servo

We've learned to turn the servo to a specific angle using an external signal. In the new project, we will use a potentiometer to control a servo. You can also modify this circuit by swapping the potentiometer for a sensor such as a tilt switch, or changing the actuator to an LED. Get tinkering and use your imagination!

Component

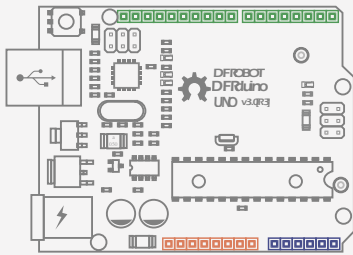

DFRduino UNO R3 x1

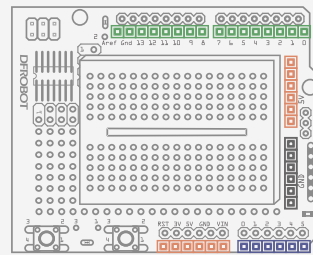

Prototype Shield x1



Jumper Cables M/M

x3



Jumper Cables F/M

x3



10K Potentiometer

x1



Servo

x1

Circuit

This is a little different from our previous project as we are using a potentiometer. Potentiometers are sometimes called variable resistors, and they are just that. By turning the knob, you are altering the electrical resistance of the component. It has 3 pins: two side by side and one on top. Connect the side by side pins to 5V and GND on the Arduino respectively, and the single pin on the opposite side of the potentiometer to the analog 0 pin on the Arduino.

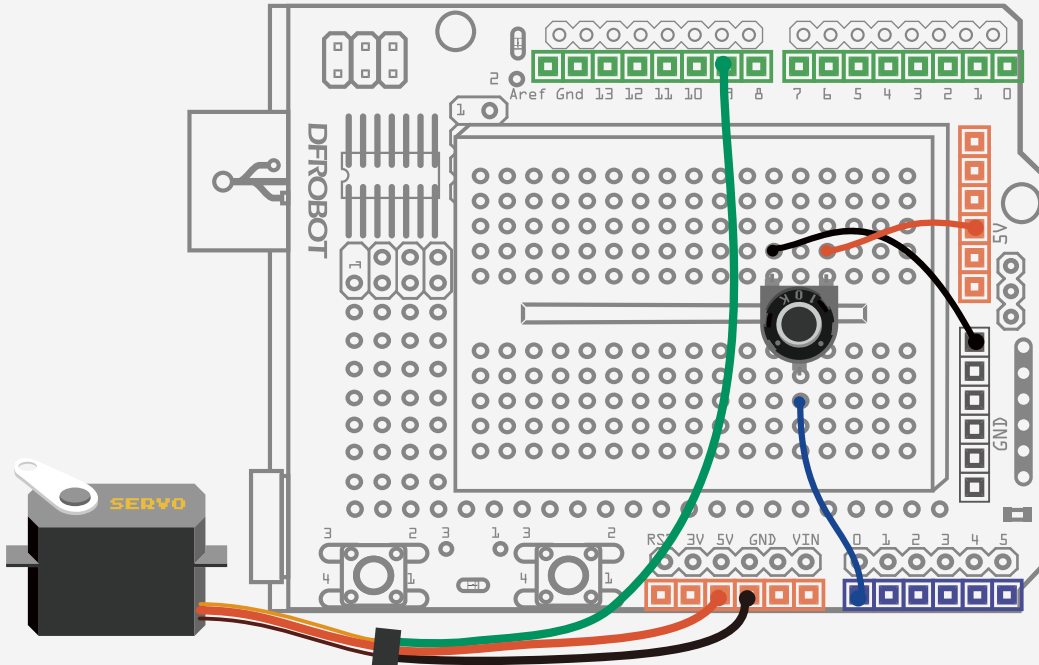

Fig. 11-1 Controllable Servo Circuit Diagram

Code

Sample code 11-1

```
//Project eleven controllable servo

#include <Servo.h>    // insert the Servo.h library
Servo myservo;      // create servo object to control servo

int potpin = 0;     // connect potentiometer to digital pin0
int val;           // variable value to read value from analog pin

void setup() {
  myservo.attach(9); //Attach the servo on pin 9 to the servo object.
}

void loop() {
  val = analogRead(potpin); //reads the value of the potentiometer
                             // (value between 0 and 1023)
  val = map(val, 0, 1023, 0, 179); // scale it to use it with the servo (value
  // between 0 and 180)
  myservo.write(val); // sets the servo position according to the
  // scaled value
  delay(15); // wait for 15 ms to turn to certain position
}
```

After uploading the sketch, you can see the servo turn according to the position of the potentiometer.

Code

We declare to insert the `<Servo.h>` library first and then define the potentiometer on Analog pin 0 to read its value.

Now let's dig into the "map" function.

The format of map function is as below:

```
map(value, fromLow, fromHigh,  
toLow, toHigh)
```

The "map" function re-maps a number from one range to another. That is, a value of "fromLow" would get mapped to "toLow", a value of "fromHigh" to "toHigh", values in-between to values in-between, etc.

Parameters

value: the number to map

fromLow: the lower bound of the value's current range

fromHigh: the upper bound of the value's current range

toLow: the lower bound of the value's target range

toHigh: the upper bound of the value's target range

Note that the "lower bounds" of either range may be larger or smaller than the "upper bounds" so the "map()" function may be used to reverse a range of numbers, e.g.:

```
y = map(x, 1, 50, 50, 1);
```

The function also handles negative numbers well, so that this example is also valid and works well:

```
y = map(x, 1, 50, 50, -100);  
val = map(val, 0, 1023, 0, 179);
```

Back to our sketch: we map the analog value from 0 to 1023 to a servo value from 0 to 180.

Circuit

Potentiometer

A potentiometer is a simple knob that provides a variable resistance ranging from 0 to 10k Ω , which Arduino can read as an analog value. In this project, we connected three wires to the Arduino. The first went to ground from one of the outer pins of the potentiometer. The second went from 5 volts to the other outer pin of the potentiometer. The third went from analog input 2 to the middle pin of the potentiometer.

A potentiometer works in a similar way to the voltage divider in project 9. The potentiometer is divided into 2 resistors by the shaft. By turning the shaft of the potentiometer, we change the amount of resistance on either side of the wiper which is connected to the center pin of the potentiometer. This changes the relative "closeness" of that pin to 5 volts and ground, giving us a different analog input. When the shaft is turned all the way in one direction, there are 0 volts going to the pin, and we read 0. When the shaft is turned all the way in the other direction to the upper limit, there are 5 volts going to the pin, and we read 1023. In between, "analogRead()" returns a number between 0 and 1023 that is proportional to the amount of voltage being applied to the pin.

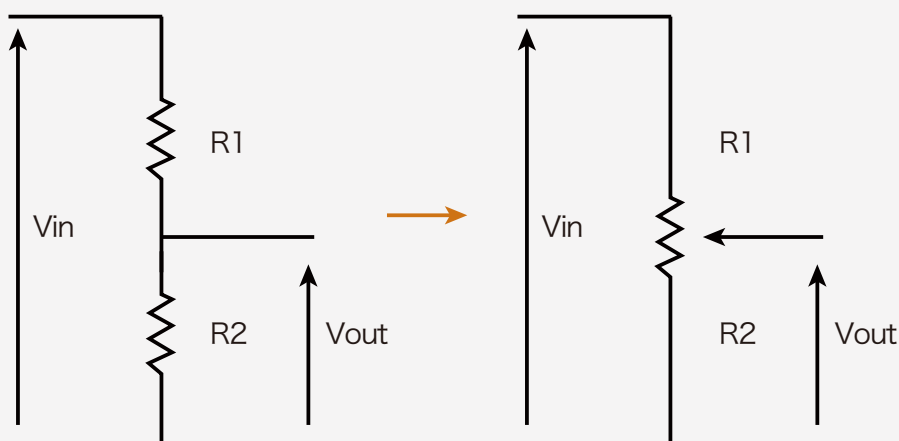
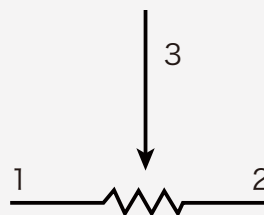

Project 12





Interactive Adjustable RGB LED

12

Interactive Adjustable RGB LED

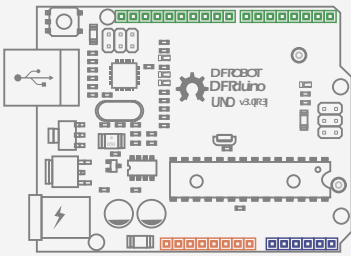
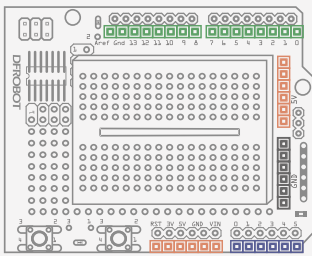
In Project 5, we learned about how to adjust an RGB LED to various colors. This time we will try to make it interactive by adding 3 potentiometers so that you can choose any color you want for your lighting at home.

Component

	DFRduino UNO R3 x1		Prototype Shield x1
	Jumper Cables M/M x13		Resistor 220R x3
	10K Potentiometer x3		5mm RGB LED x1

Circuit

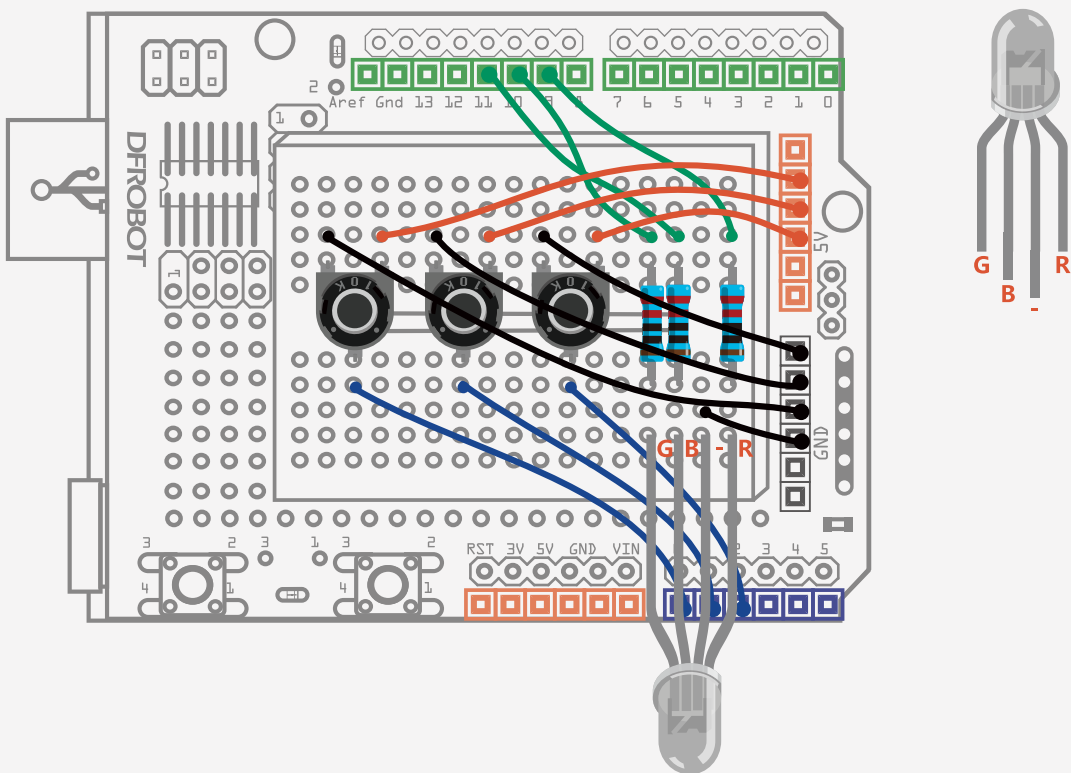

Fig. 12-1 Interactive Adjustable RGB LED Circuit diagram

Code

```
//Sample Code 12-1:
int redPin = 9;           // R – digital 9
int greenPin = 10;       // G – digital 10
int bluePin = 11;        // B – digital 11
int potRedPin = 0;       // potentiometer 1 – analog 0
int potGreenPin = 1;     // potentiometer 2 – analog 1
int potBluePin = 2;      // potentiometer 3 – analog 2

void setup(){
  pinMode(redPin,OUTPUT);
  pinMode(greenPin,OUTPUT);
  pinMode(bluePin,OUTPUT);
  Serial.begin(9600);    // Initialize the serial port
}

void loop(){
  int potRed = analogRead(potRedPin); // read value from potentiometer of
red LED
  int potGreen = analogRead(potGreenPin); // read value from potentiometer of
green LED
  int potBlue = analogRead(potBluePin); // read value from potentiometer of
blue LED
  int val1 = map(potRed,0,1023,0,255); //map the voltage value ranging from
0~ 1023 to analog value ranging from 0 ~255
  int val2 = map(potGreen,0,1023,0,255);
  int val3 = map(potBlue,0,1023,0,255);

  // print value of red, green and blues LEDs from serial port
  Serial.print("Red:");
  Serial.print(val1);
  Serial.print("Green:");
  Serial.print(val2);
  Serial.print("Blue:");
  Serial.println(val3);
  colorRGB(val1,val2,val3); // configure the analog value for RGB LED
}

//define the colorRGB function
void colorRGB(int red, int green, int blue){
  analogWrite(redPin,constrain(red,0,255));
  analogWrite(greenPin,constrain(green,0,255));
  analogWrite(bluePin,constrain(blue,0,255));
}
```

After uploading the sketch, you can change different combinations of red, green and blue colors on the RGB LED.

Project 13

DIY Fan

13

DIY Fan

In this project, we will use a relay and a motor to make a small fan. A relay is an electrically operated switch that allows you to turn on or off a circuit using voltage and/or current much higher than the Arduino can handle.

Component

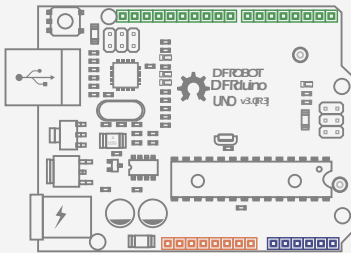

DFRduino UNO R3

x1

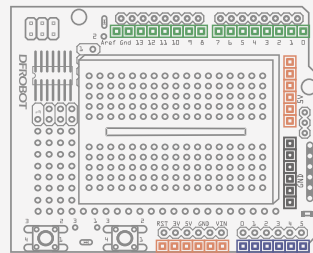

Prototype Shield

x1



Jumper Cables
M/M

x9



5MM LED

x1

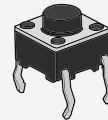

Pushbutton

x1



Resistor 220R

x2



Relay

x1



130 Motor

x1



Fan

x1

Wiring

Connect the button with a 220Ω pull-down resistor in order to hold the logic signal near zero volts when the button is disconnected. The relay has 6 pins. Pin 1 and 2 on the relay are input signals and are separately connected to digital pin 3 and GND on the Arduino. Pins 3, 4, 5, and 6 on the relay are the output signals but we will only use pin 4 and pin 6 at this time. A relay is similar to a push button, which has 2 connections as well.

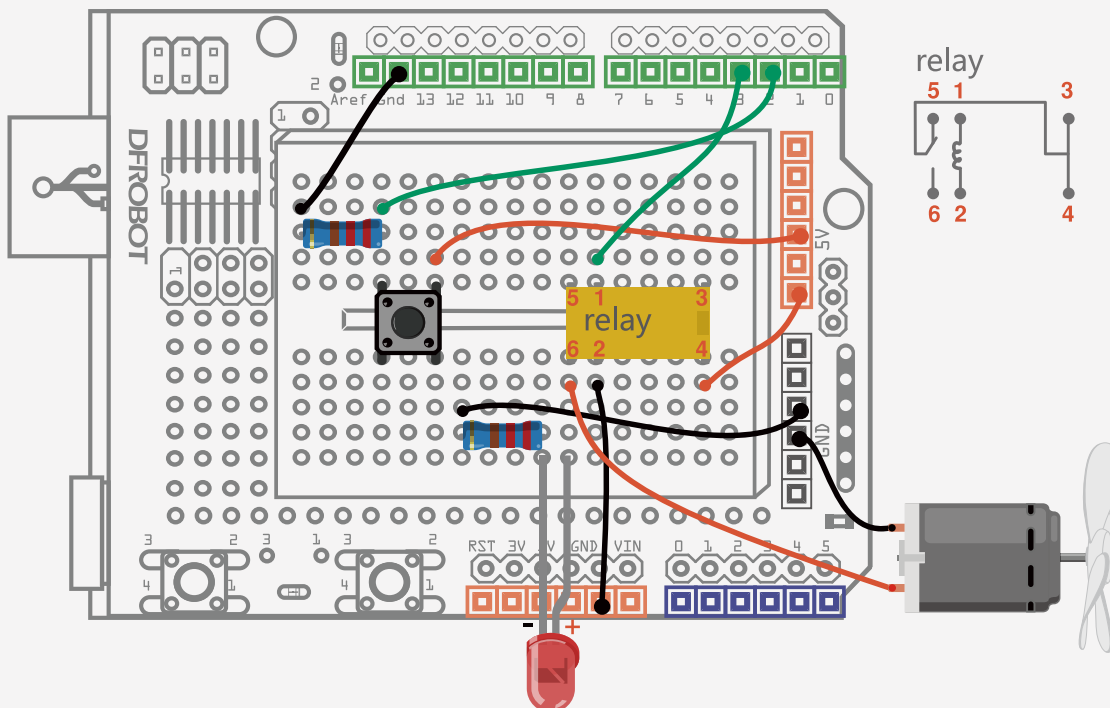

Fig. 13-1 DIY Fan Circuit Diagram

Code

Sample Code 13-1:

```
//Project thirteen - the Arduino to control fan operation
int buttonPin = 2;           // int buttonPin = 2 ;
int relayPin = 3;           // int relayPin = 3;
int relayState = HIGH;      // int relayState = HIGH;
int buttonState;            // record the current button state
int lastButtonState = LOW;  // record the last button state
long lastDebounceTime = 0;
long debounceDelay = 50;    // eliminate debounce time

void setup() {
  pinMode(buttonPin, INPUT);
  pinMode(relayPin, OUTPUT);

  digitalWrite(relayPin, relayState);    // configure the initial state of relay
}

void loop() {
  int reading = digitalRead(buttonPin);  //read the value of button

  // once detects change of state, record time
  if (reading != lastButtonState) {
    lastDebounceTime = millis();
  }

  // wait for 50ms to evaluate if it is the same state as last state
  // if different, change the button state
  // if the state of button is high(pressed), change the state of relay
  if ((millis() - lastDebounceTime) > debounceDelay) {
    if (reading != buttonState) {
      buttonState = reading;

      if (buttonState == HIGH) {
        relayState = !relayState;
      }
    }
  }
  digitalWrite(relayPin, relayState);

  //change the last state of button
  lastButtonState = reading;
}
```

After uploading the sketch, you can control the relay and LED with the button.

Code

The debounce of push button is the

```
if (reading != lastButtonState) {  
  lastDebounceTime = millis();  
}  
if ((millis() - lastDebounceTime) > debounceDelay) {  
  if (reading != buttonState) {  
    .....  
  }  
}
```

When signals are received by the Arduino, the program does not operate on them immediately - it tests if the signal is correct and waits for a certain time to confirm. If the signal is correct, the program will be operating accordingly.

The reason the program tests for a correct signal is because there is a bouncing process for the button when pressed. It might generate the wrong signal, so we test it to solve the problem in hardware.

Hardware

Relay

A relay is an electrically operated switch that allows you to turn on or off a circuit using voltage and/or current much higher than the Arduino can normally handle. There is no connection between the low voltage circuit operated by Arduino and the high power circuit - the relay isolates the circuits from each other.

Let's take a look at the inner structure of relay:

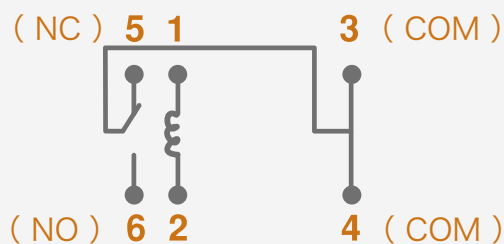

Relays have 6 pins. Pins 1 and 2 are connected to the digital pin and GND. We use these 2 pins to power the relay. There is a coil between Pin 1 and Pin 2. When the circuit is HIGH, current flows in the coil, generates a magnetic field, closes the switch contacts and **connects the NO (Normally Open) to COM(common) pin**. When the circuit is LOW, no current runs in the coil, **therefore the NC (Normally Closed) connects to the common pin**. We connect Pin 4 and Pin 6 to control the switching on and off of the relay and the the LED.

The difference between the DC motor, Stepper Motors and Servos

DC (Direct Current) motors are devices that change electrical energy to kinetic energy. When you supply power to a DC motor it will start spinning continuously until that power is removed. When you switch the polarities, it will spin in the opposite direction. A motor runs continuously at a high RPM (revolutions per minute). These revolutions of the motor shaft can not be controlled to a specific angle, but you can control the speed. Because the rotations are so fast, it is impractical to use it for vehicles.

A stepper motor has a gearing set on the DC motor to step down the speed and increase torque. This makes it more practical to use for vehicle applications. Its speed can be controlled by PWM.

A servo is also a motor. It controls the position of the motor by a feedback system, as we saw in the servo projects covered. Servos are practical to use for robotics arms.

Project 14

IR Remote Controlled LED

14

IR Remote Controlled LED

An infrared receiver, or IR receiver, is hardware device that sends information from an infrared remote control to another device by receiving and decoding signals. In general, the receiver outputs a code to uniquely identify the infrared signal that it receives. This code is then used in order to convert signals from the remote control into a format that can be understood by the other device. Because infrared is light, it requires line-of-sight visibility for the best possible operation, but can however still be reflected by items such as glass and walls. Poorly placed IR receivers can result in what is called "tunnel vision", where the operational range of a remote control is reduced because they are set so far back into the chassis of a device.

Warm-up Experiment: Components

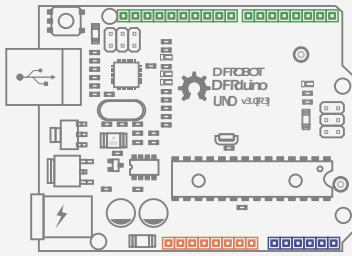

DFRduino UNO R3
x1

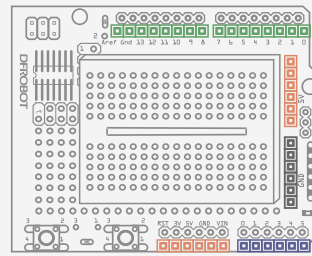

Prototype Shield
x1



**Jumper Cables
M/M**
x3

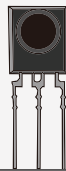

IR Receiver
x1



**IR Remote
controller**
x1

Wiring

Note that the "V-out" lead of the infrared receiver must be connected to Digital Pin 11 on the Arduino.

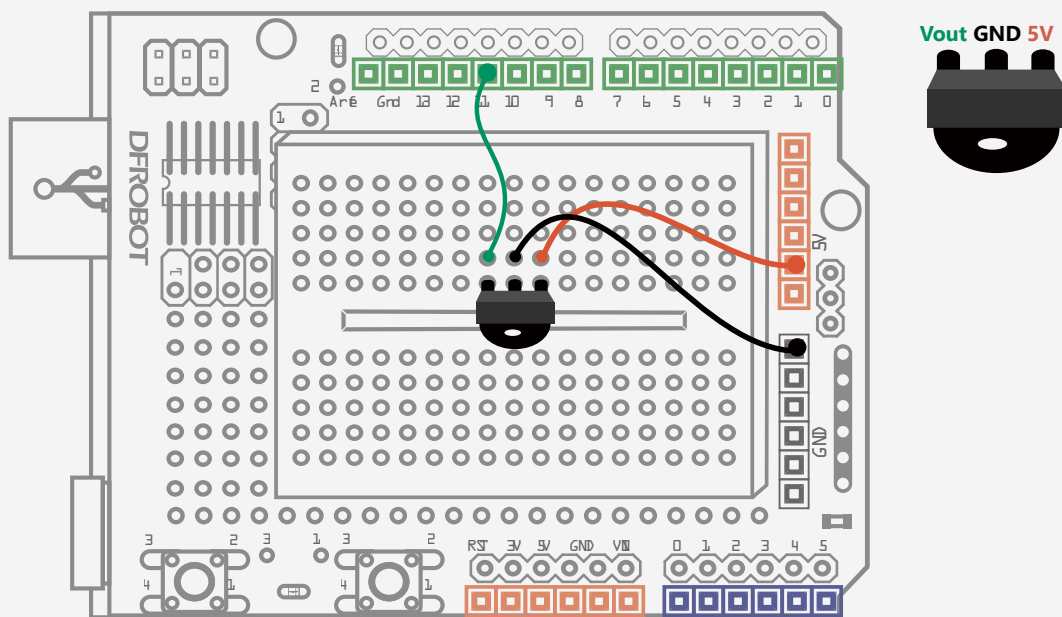

Fig. 14-1 IR Receiver Diagram

Code

We need to invoke the "IRremote" library first. Unzip the RAR and save it to the file Arduino libraries directory. Run "IRrecvDemo" in the example.

If you don't know how to invoke a library in the Arduino IDE, refer back to the exercise in Project 5.

This sketch is from "IRrecvDemo" in the examples of the "IRremote" library.

Sample code 14-1:

```
//project fourteen – infrared receiving tube
#include <IRremote.h>    // insert IRremote.h library
int RECV_PIN = 11;      //define the pin of RECV_PIN 11
IRrecv irrecv(RECV_PIN); //define RECV_PIN as infrared receiver
decode_results results; //define variable results to save the result of infrared
receiver

void setup(){
  Serial.begin(9600);    // configure the baud rate 9600
  irrecv.enableIRIn();  //Boot infrared decoding
}

void loop() {
  //test if receive decoding data and save it to variable results
  if (irrecv.decode(&results)) {
    // print data received in a hexadecimal
    Serial.println(results.value, HEX);
    irrecv.resume(); //wait for the next signal
  }
}
```

After uploading the code, open the serial monitor of the Arduino IDE and configure the baud rate 9600 in line with `Serial.begin(9600)`.



After configuration, press the button on the remote controller towards the infrared receiver. Each button has a hexadecimal code. We can see the code on serial monitor no matter which button we press. For example, we press button "0", the hexadecimal code received is FD30CF.

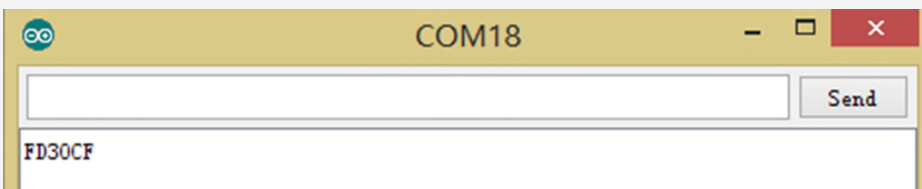

If you keep pressing one button, the serial monitor reads "FFFFFFFF".

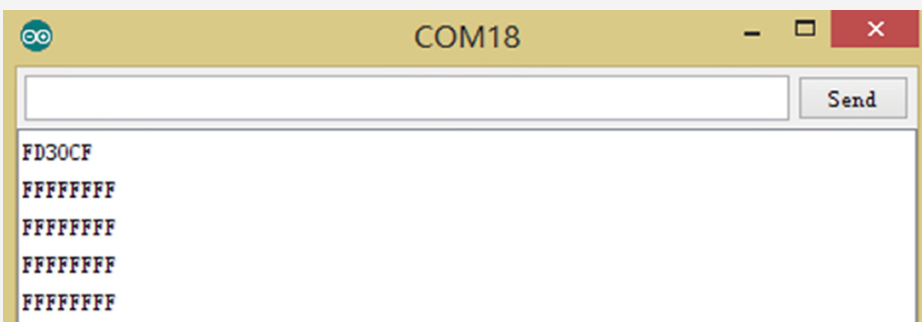

If it is received properly in the serial port, the code should be six digits starting with FD. If the controller does not send out the signal towards the infrared receiver, it might receive wrong code as we can see below.

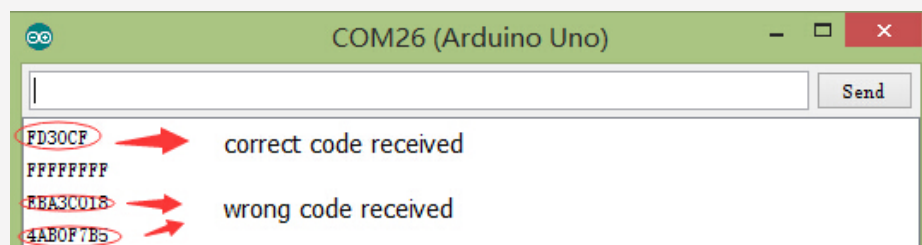

The original infrared decoding is too complicated to manipulate, which is why we use the library that is built by others without completely understanding it. Since we have got the idea of decoding for infrared signal, let's make an infrared controlled LED.

Remote Control LED

Component

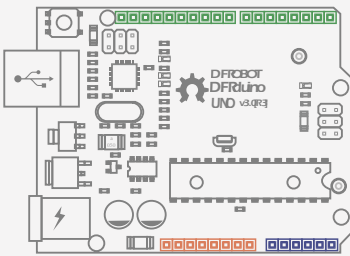

DFRduino UNO R3 x1

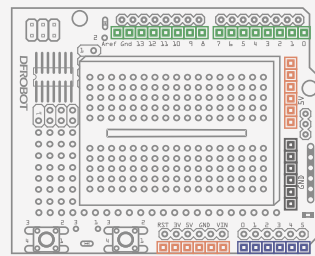

Prototype Shield x1



Jumper Cables M/M x3

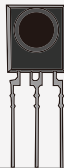

IR Receiver x1



IR Remote controller x1



5MM LED x1



Resistor 220R x1

x1

Wiring

Based on the previous circuit, add an LED and a resistor. Connect the LED to digital pin 10 and the signal LED of infrared receiver to digital pin 11.

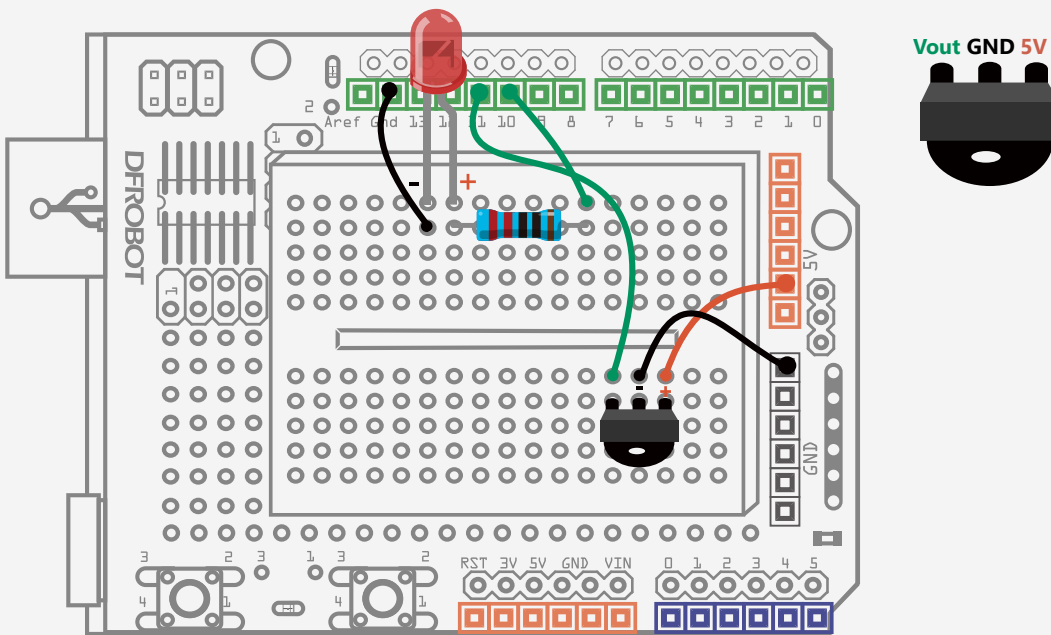

Fig. 14-2 IR Remote Controlled LED Circuit Diagram

Code

Sample Code 14-2:

```
#include <IRremote.h>
int RECV_PIN = 11;
int ledPin = 10;           // LED – digital 10
boolean ledState = LOW;   // ledState to store the state of LED
IRrecv irrecv(RECV_PIN);
decode_results results;

void setup(){
  Serial.begin(9600);
  irrecv.enableIRIn();
  pinMode(ledPin,OUTPUT); // define LED as output signal
}

void loop() {
  if (irrecv.decode(&results)) {
    Serial.println(results.value, HEX);

    //once receive code from power button, the state of LED is changed from HIGH
to LOW or from LOW to HIGH.
    if(results.value == 0xFD00FF){
      ledState = !ledState; //reverse
      digitalWrite(ledPin,ledState); //change the state of LED
    }
    irrecv.resume();
  }
}
```

Code

Defining the infrared receiver is the same as the last sketch.

```
#include <IRremote.h>    //insert IRremote.h library
int RECV_PIN = 11;      //define the pin of
RECV_PIN 11
IRrecv irrecv(RECV_PIN); //define RECV_PIN as infrared
receiver
decode_results results; //define variable results to
save the result of infrared receiver
int ledPin = 10;        //LED – digital 10
boolean ledState = LOW; //Ledstate used to store the
LED status
```

In the setup() function, we use serial port to boot the infrared decoding and configure pinMode of digital pins. In the main program, we test if receive infrared signal and store data in the results variable.

```
if (irrecv.decode(&results))
```

Once the Arduino receives data, the program does two things: first it tests whether infrared code is received from the power button.

```
if(results.value == 0xFD00FF)
```

The second thing is to make the LED change state.

```
ledState = !ledState; //Flip
digitalWrite(ledPin,ledState); //Change corresponding LED status
```

You might not be so familiar with "!". "!" is a logical NOT.

"!ledState" is the opposite state of "ledState". "!" is only used in the variable that only holds 2 states, or boolean type of variable.

Next, the Arduino will wait for the next signal.

```
irrecv.resume();
```

Exercise

-
1. Combine the fan project with the current project. Add one more function to the mini controller to control a LED and a fan.
 2. Make a DIY a remote controlled project, e.g.: a small figure that can move with servos controlled by infrared signals.

Project 15

IR Remote Controlled LED Module

15

IR Remote Controlled LED Module

An 8-segment LED is a formed of electronic display device for displaying decimal numerals. It is an alternative to more complex dot matrix displays. By controlling each LED in each segment connected to a digital pin, numbers can be displayed on this LED.

Components

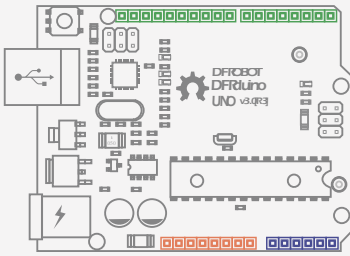

DFRduino UNO R3
x1

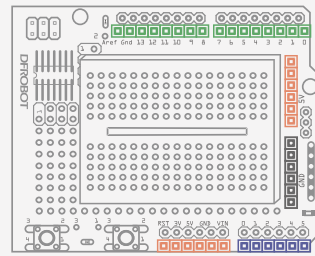

Prototype Shield
x1



Jumper Cables
M/M
x10



Resistor 220R
x8



8-Segment LED
x1

Wiring

The 8 segment LED has 10 pins. The 5 pins on the upper position are connected to digital pin 2 to digital pin 5. The other 5 pins on the lower position with decimal point are connected to digital pin 6 to 9. 8 resistors are included to limit the current for the LEDs.

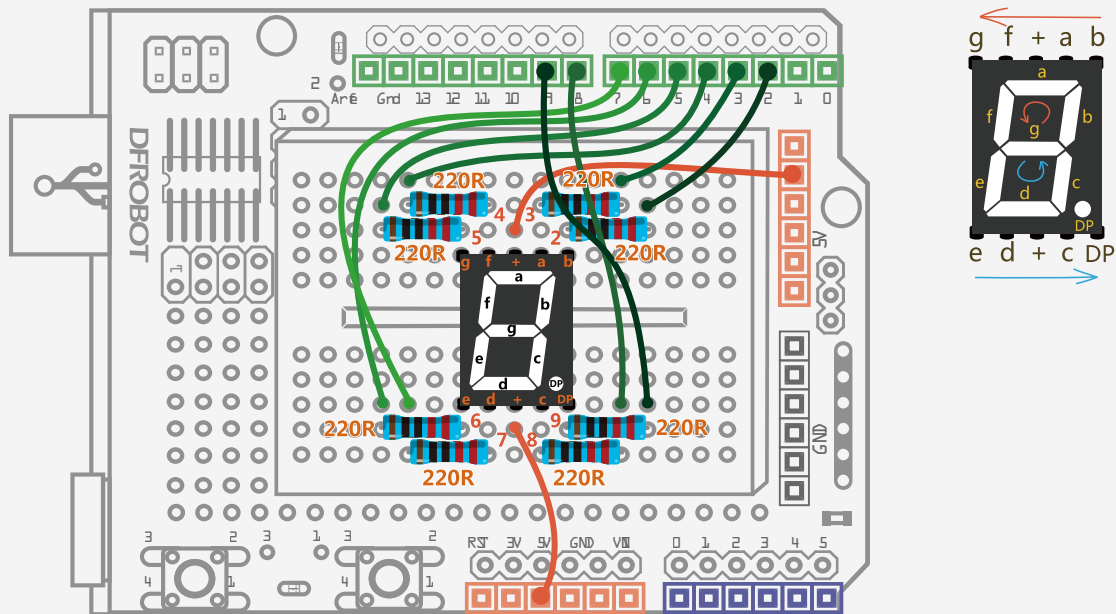

Fig. 15-1 LED Module Display Circuit Diagram

Code

Sample Code 15-1:

```
//Project 15 - digital tube display
void setup(){
  for(int pin = 2 ; pin <= 9 ; pin++){ // define digital pin 2-9 as output
    pinMode(pin, OUTPUT);
    digitalWrite(pin, HIGH);
  }
}

void loop() {
  // display number 0
  int n0[8]={0,0,0,1,0,0,0,1};
  //display the array of n0[8] in digital pin 2-9
  for(int pin = 2; pin <= 9 ; pin++){
    digitalWrite(pin,n0[pin-2]);
  }
  delay(500);

  // display number1
  int n1[8]={0,1,1,1,1,0,1};
  // display the array of n1[8] in digital pin 2-9
  for(int pin = 2; pin <= 9 ; pin++){
    digitalWrite(pin,n1[pin-2]);
  }
  delay(500);

  // display number 2
  int n2[8]={0,0,1,0,0,0,1,1};
  // display the array of n2[8] in digital pin 2-9
  for(int pin = 2; pin <= 9 ; pin++){
    digitalWrite(pin,n2[pin-2]);
  }
  delay(500);

  // display number 3
  int n3[8]={0,0,1,0,1,0,0,1};
  // display the array of n3[8] in digital pin 2-9
  for(int pin = 2; pin <= 9 ; pin++){
    digitalWrite(pin,n3[pin-2]);
  }
  delay(500);

  // display number 4
  int n4[8]={0,1,0,0,1,1,0,1};
  // display the array of n4[8] in digital pin 2-9
```



```
for(int pin = 2; pin <= 9 ; pin++){
    digitalWrite(pin,n4[pin-2]);
}
delay(500);

// display number 5
int n5[8]={1,0,0,0,1,0,0,1};
// display the array of n5[8] in digital pin 2-9
for(int pin = 2; pin <= 9 ; pin++){
    digitalWrite(pin,n5[pin-2]);
}
delay(500);

// display number 6
int n6[8]={1,0,0,0,0,0,0,1};
//display the array of n6[8] in digital pin 2-9
for(int pin = 2; pin <= 9 ; pin++){
    digitalWrite(pin,n6[pin-2]);
}
delay(500);

// display number 7
int n7[8]={0,0,1,1,1,1,0,1};
// display the array of n7[8] in digital pin 2-9
for(int pin = 2; pin <= 9 ; pin++){
    digitalWrite(pin,n7[pin-2]);
}
delay(500);

// display number 8
int n8[8]={0,0,0,0,0,0,0,1};
// display the array of n8[8] in digital pin 2-9
for(int pin = 2; pin <= 9 ; pin++){
    digitalWrite(pin,n8[pin-2]);
}
delay(500);

// display number 9
int n9[8]={0,0,0,0,1,1,0,1};
// display the array of n9[8] in digital pin 2-9
for(int pin = 2; pin <= 9 ; pin++){
    digitalWrite(pin,n9[pin-2]);
}
delay(500);
}
```

Circuit

8-segment LED

The 8-segment display has 10 pins: a, b, c, d, e, f, g and DP segments (decimal point). Each are connected to digital pins. By controlling each LED on the segment connected, numbers can be displayed on this LED. The other pin is a common pin that connected to GND(common cathode) or 5V (common anode).

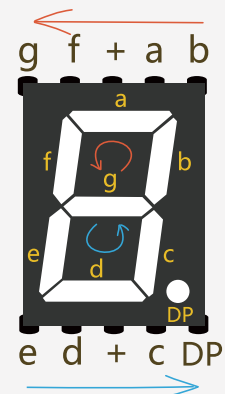

Fig. 15-2 Pin-out Instructions

Common Cathode and Common Anode Differences

All of the cathodes (negative terminals) or all of the anodes (positive terminals) of the segment LEDs are connected and brought out to a common pin; this is referred to as a "common cathode" or "common anode" device. The common pin of cathodes LEDs is connected to GND. When you configure this pin HIGH, it triggers the LED to be on. The common pin of anode LEDs is connected to 5V. When you configure this pin LOW, it triggers the LED to be off.

Code

The 8-segment LED is connected to 8 digital pins so we need to define 8 digital pins with "FOR" loops to simplify things. Segment b, a, f, g, e, d, c, DP correspond to digital pins from 2 to 9.

```
for(int pin = 2 ; pin <= 9 ; pin++){
  pinMode(pin, OUTPUT);
  digitalWrite(pin, HIGH);
}
```

Set pins from 2 to 9 as "OUTPUT" and initialize them HIGH.

The main program is to display number from 0 to 9. Let us take a look at the code of displaying 0.

```
int n0[8]={0,0,0,1,0,0,0,1};
```

Here we introduce the concept of an array. An array is a collection of variables that are accessed with an index number. We declare an array of "int" type, name it "n0" and assign 8 values to initialize it. Note that arrays are zero indexes. When declaring an array of type, one more element than your initialization is required to hold the required null character. Referring to the array initialization above, the forth element of the array is at index 3(n0[3]) and its value is 1. The eighth element of the array is at index 7 (n0[7]) and its value is 1. The 8 inside the square brackets (n0[8]) means 8 elements.

After defining the array, we enter a "for" loop.

```
for(int pin = 2; pin <= 9 ; pin++){
  digitalWrite(pin,n0[pin-2]);
}
```

The "for" loop is to assign values HIGH/1 or LOW/0 to 2-9 pins. For example, when pin=2, n0[pin-2] is n0[0] which points to the first element of the array with value 0/LOW. So the b segment is on. When the for loops goes to pin=3, the a segment is on. When the for loops goes to pin=4, the f segment is on, etc.

The loop's process is as below:

```
pin= 2 → n0 [0] =0→digitalWrite(2,0) →b segment on
pin= 3 → n0 [1] =0→digitalWrite(3,0) →a segment on
pin= 4 → n0 [2] =0→digitalWrite(4,0) →f segment on
pin= 5 → n0 [3] =1→digitalWrite(5,1) →g segment off
pin= 6 → n0 [4] =0→digitalWrite(6,0) →e segment on
pin= 7 → n0 [5] =0→digitalWrite(7,0) →d segment on
pin= 8 → n0 [6] =0→digitalWrite(8,0) →c segment on
pin= 9 → n0 [7] =1→digitalWrite(9,1) →DP segment off
```

Now it displays 0. It displays 1 to 9 based on array. Just try to draw it out and the light-on-and-off status is clear.

An easier method is to be introduced based on the understanding of code 1. This will be introduced on the following page.

Code 2

In this section, we will introduce an even simpler way to manipulate the loops for number 0 to 9 in the 8-segment LED. In the sketch above, we created 10 arrays to display 0 to 9. This is a one-dimensional array. What about creating a two-dimensional array to make it simpler?

Sample code 15-2:

```
//Item 11 - digital tube digital display
int number[10][8] =
{
  {0,0,0,1,0,0,0,1}, //display 0
  {0,1,1,1,1,0,1}, //display 1
  {0,0,1,0,0,0,1,1}, //display 2
  {0,0,1,0,1,0,0,1}, //display 3
  {0,1,0,0,1,1,0,1}, //display 4
  {1,0,0,0,1,0,0,1}, //display 5
  {1,0,0,0,0,0,0,1}, //display 6
  {0,0,1,1,1,1,0,1}, //display 7
  {0,0,0,0,0,0,0,1}, //display 8
  {0,0,0,0,1,1,0,1} //display 9
};
void numberShow(int i){ //call this function to display numbers
  for(int pin = 2; pin <= 9 ; pin++){
    digitalWrite(pin, number[i][pin - 2]);
  }
}
void setup(){
  for(int pin = 2 ; pin <= 9 ; pin++){ // define digital pins 2 to 9 as output
    pinMode(pin, OUTPUT);
    digitalWrite(pin, HIGH);
  }
}

void loop() {
  for(int j = 0; j <= 9 ; j++){
    numberShow(j); // call numberShow() function to
    display 0-9.
    delay(500);
  }
}
```

Code 2

The one-dimensional array is composed with elements and the two-dimensional array is composed with one-dimensional arrays.

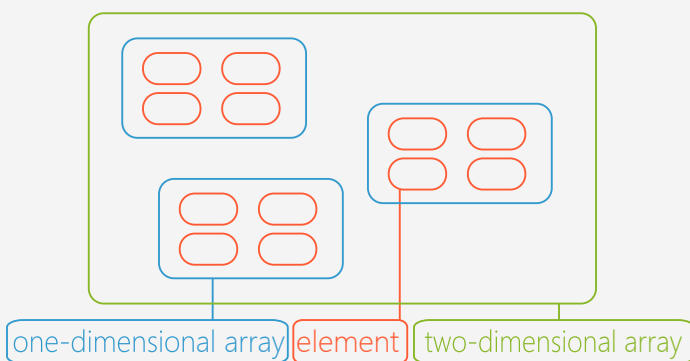

In the first sketch, we manipulated 10 arrays, each with 8 elements corresponding to values in the segment from b to DP. In this sketch, we will manipulate 10 one-dimensional arrays together to form a two-dimensional array.

```

int number[10][8] =
{
  {0,0,0,1,0,0,0,1}, // display0
  {0,1,1,1,1,0,1}, // display1
  {0,0,1,0,0,0,1,1}, // display2
  {0,0,1,0,1,0,0,1}, // display3
  {0,1,0,0,1,1,0,1}, // display4
  {1,0,0,0,1,0,0,1}, // display5
  {1,0,0,0,0,0,0,1}, // display6
  {0,0,1,1,1,1,0,1}, // display7
  {0,0,0,0,0,0,0,1}, // display8
  {0,0,0,0,1,1,0,1} // display9
};

```

Diagram annotations: A box labeled 'number[0][0]' points to the first element of the first array. A box labeled 'number[9][7]' points to the last element of the last array.

This is the two-dimensional array. It starts from the character "null". So number[0][0] is the first element in first array whose value is 0. Number [9][7] is the eighth element in the tenth array whose value is 1.

```

void numberShow(int i){
  // this function is to display numbers
  for(int pin = 2; pin <= 9 ; pin++){
    digitalWrite(pin, number[i][pin - 2]);
  }
}

```

```

void loop() {
  for(int j = 0; j <= 9 ; j++){
    numberShow(j);
    // call numberShow() function to display 0 to 9
    delay(500);
  }
}

```

In the main program, the "for" loops manipulate the variable "j" to loop from 0 to 9. Once "j" is assigned with a value, the "numberShow()" function runs accordingly.

The "numberShow()" function runs as below:

When the program begins with j=0, "numberShow(j)" is "numberShow(0)". As it skips to the "numberShow()" function, the value of i is 0 and the initial value of the pin is 2. The value of digitalWrite(0 is digitalWrite(2,number[0][0]) whose value is 0. digitalWrite(2,0) means to configure pin 2 as LOW, so the LED of segment b is HIGH. Afterwards, the loops go to pin=3, pin=4, ..., until pin=9 when the whole for loop is finished and 0 displays on the 8-segment LED.

Compare how we displayed 0 in the first sketch.

```
// display number 0
int n0[8]={0,0,0,1,0,0,0,1};
// display the array of n0[8] in digital pin 2-9
for(int pin = 2; pin <= 9 ; pin++){
digitalWrite(pin,n0[pin-2]);
}
```

The principle of assigning value for pin 2 to 9 to control segment from b to DP is the same.

When numberShow(0) loop is finished, it goes back to the for loop function.

1 → numberShow(1) → i=1 → number[1][pin-2] → display 1

j=2 → numberShow(2) → i=2 → number[2][pin-2] → display 2

j=3 → numberShow(3) → i=3 → number[3][pin-2] → display 3

.....

j=9 → numberShow(9) → i=9 → number[9][pin-2] → displays 9

The above is the analysis for the codes. Just think about the differences between the one dimensional array and the two dimensional array and how the codes operate.

The combined application of the LED module and IR receiver is to be achieved after handling their operating principles. The Arduino compatible controller processes and delivers the signal transferred from the Mini remote controller to the IR receiver to the LED module.

Numbers from 0 to 9 on the mini remote controller are to be displayed on corresponding positions on the LED module. In addition, decreasing and increasing functions are feasible.

Components

Components

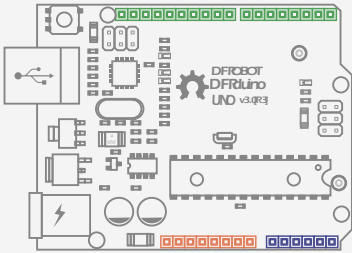

x1
DFRduino UNO R3

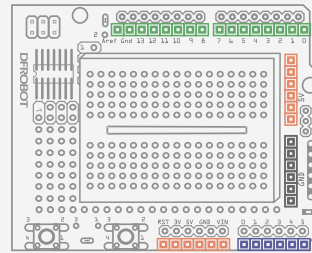

x1
Prototype Shield



x13
Jumper Cables
M/M



x8
Resistor 220R



x1
8-Segment LED

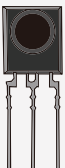

x1
IR Receiver



x1
IR Remote controller

Wiring

In this project, we are going to simply combine the hardware connections of Project 14 and Project 15. There are few changes. If there are any problems with the LED module connections, go back and review Project 15.

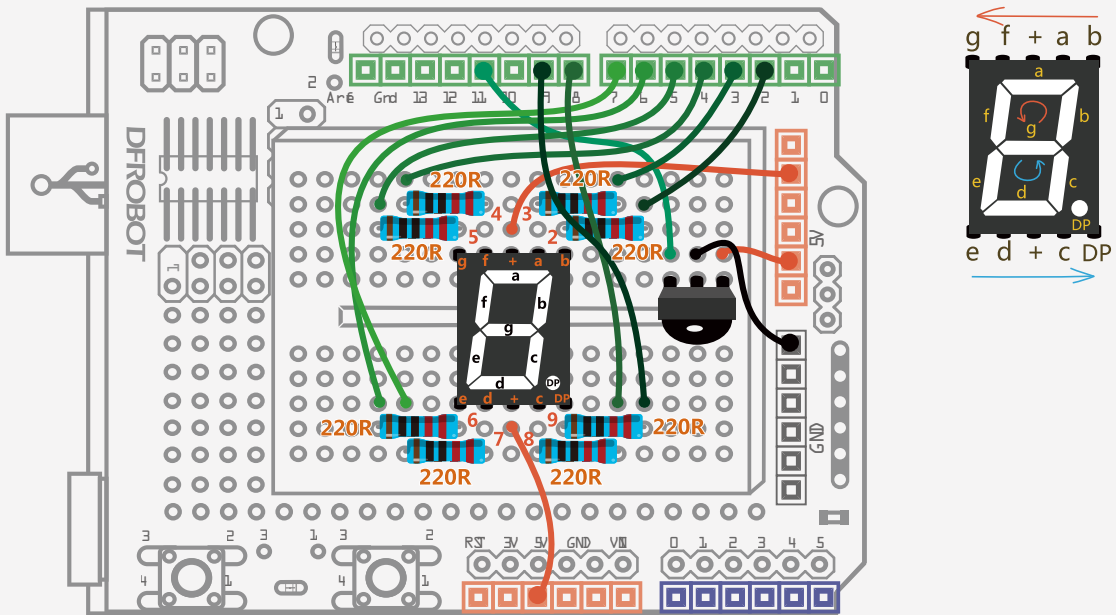

Fig. 15-3 IR Remote Controlled LED Module Diagram

Code

Sample code 13-1

```

Project 13 - IR Remote Controlled LED Module
#include <IRremote.h> //Call IRremote.h Library.
int RECV_PIN = 11; //Dim RECV_PIN as 11
IRrecv irrecv(RECV_PIN); //Set RECV_PIN (Pin-out 11) as the IR receiver port.
decode_results results; //Set results as the IR records storage position.
int currentNumber = 0; //The variable is for current number storage.

long codes[12]= //The array is for IR codes storage delivered by
the IR remote controller.
{
  0xFD30CF,0xFD08F7, // 0 ,1
  0xFD8877,0xFD48B7, // 2 ,3
  0xFD28D7,0xFDA857, // 4 ,5
  0xFD6897,0xFD18E7, // 6 ,7
  0xFD9867,0xFD58A7, // 8 ,9
  0xFD20DF,0xFD609F, // + ,-
};

int number[10][8] = //The array is for numbers storage displayed on
the LED module.
{
  {0,0,0,1,0,0,0,1},//0
  {0,1,1,1,1,0,1},//1
  {0,0,1,0,0,0,1,1},//2
  {0,0,1,0,1,0,0,1},//3
  {0,1,0,0,1,1,0,1},//4
  {1,0,0,0,1,0,0,1},//5
  {1,0,0,0,0,0,0,1},//6
  {0,0,1,1,1,0,1},//7
  {0,0,0,0,0,0,0,1},//8
  {0,0,0,0,1,1,0,1},//9
};

void numberShow(int i) { //The function works to display numbers on the
LED module.
for(int pin = 2; pin <= 9 ; pin++){
  digitalWrite(pin, number[i][pin - 2]);
}
}

void setup(){
  Serial.begin(9600); //Set the baud rate as 9600.
  irrecv.enableIRIn(); //Launch IR decoding.

for(int pin = 2 ; pin <= 9 ; pin++){ //Set Pin-out 2 to 9 as output mode.
  pinMode(pin, OUTPUT);
  digitalWrite(pin, HIGH);
}
}

```

```

void loop() {
  //Evaluate whether decoding data are received and store the data in
  variable results.
  if (irrecv.decode(&results)) {
    for(int i = 0; i <= 11; i++){
      //Evaluate whether IR codes are received of press button 0 to 9.
      if(results.value == codes[i]&& i <= 9){
        numberShow(i);          //Display 0 to 9 on
        corresponding position of the LED module.
        currentNumber = i;      //Assign value displayed to
        variable currentNumber.
        Serial.println(i);
        break;
      }

      // /Evaluate whether decreasing IR codes are received and the
      current value is not 0.
      else if(results.value == codes[10]&& currentNumber != 0){
        currentNumber--;        //Decrease current value.
        numberShow(currentNumber); //The LED module displays
        decreasing value.
        Serial.println(currentNumber); //The serial port outputs
        decreasing value.
        break;
      }

      //Evaluate whether decreasing IR codes are received and current
      value is not 9.
      else if(results.value == codes[11]&& currentNumber != 9){
        currentNumber++;        //Current value increases.
        numberShow(currentNumber); //The LED module displays
        increasing value.
        Serial.println(currentNumber); //The serial port outputs
        increasing value.
        break;
      }
    }

    Serial.println(results.value, HEX); //View IR codes via serial port
    monitor.
    irrecv.resume();                  //Wait for next signal.
  }
}

```

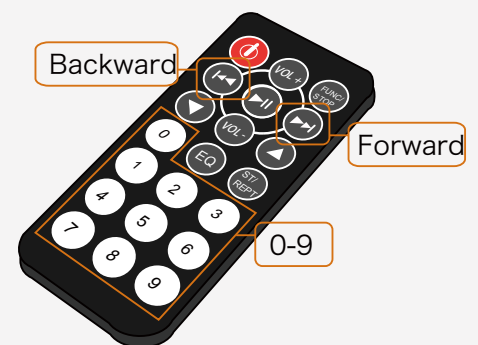

Fig. 15-4 Press Button Instructions

Codes downloaded, have a try to press some press buttons as shown in Fig. 15-4 to check the status of the LED module.

Code Review

The code below starts from the general declarations for the IR receiver. Just copy Project 12.

```
#include <IRremote.h> //Call IRremote.h library.  
int RECV_PIN = 11; //DimRECV_PIN as 11.  
IRrecv irrecv(RECV_PIN); //Set RECV_PIN (Pin-out 11) as the IR receiver port.  
decode_results results; //Set results as the IR records storage position.  
int currentNumber = 0; //The variable is for current number storage.
```

Here, there is an additional variable: "currentNumber". This variable is for current value storage. A number increasing and decreasing is for corresponding reference.

An array is applied to store these IR codes. "0x-" represents a hexadecimal. Replaced IR codes work to realize additional functions via additional buttons on the remote controller.

First step:

There are three conditions require consideration. Firstly, the 8-segment LED module should display 0 to 9 when corresponding press buttons are pressed. Secondly, every time Backward is pressed, number displayed decreases by 1 each time until it reaches 0. Thirdly, every time Forward is pressed, number displayed increases by 1 each time until it reaches 0.

To decide for above conditions, we adopt if statement. What differs from previous sample codes is that we use if...else if. What is the difference? An evaluation expression usually follows else if but not for else. However, neither else nor else if fails to work independently but an if statement is a must.

Get back to the codes for three conditions mentioned below:

```
if (results.value == codes[i]&& i <= 9)
if (results.value == codes[10]&& currentNumber != 0)
if (results.value == codes[11]&& currentNumber != 9)
```

The first "if" evaluates the first condition displaying 0 to 9. The evaluation is based on whether data is received from results. Value are from IR codes of array codes[0]~codes[9].

The second "if" evaluates the second condition whether instructions from "Backward" are received (code[10]= 0xFD20DF) and current number displayed is not 0.

The third "if" evaluates the third condition whether instructions from "Forward" are received (code[11]= 0xFDA857) and current number displayed is not 9.

Another question is how to confirm elements of the array. Therefore, there should be a "for" loop before the "if" evaluation to have variable loop among 0 to 11.

After certain IR codes confirmed, the program starts to execute the second event. There should be a corresponding executable code following every "if" statement.

Code introductions are now finished. This is the most difficult section in all of the projects we have shown and it is difficult to understand the first time round, but take it easy - practice makes perfect.

Exercises

Make a DIY remote controller that works based on this project.

Using these applications, you can make a movable toy man. You could use servos, explained in the projects mentioned before, and use different press buttons on the remote controller to have the servos move to various angles. Use your imagination and have fun.