



IR Emitter and Detector Product Data Sheet

HSDL-4261

Spec No.: DS50-2008-0026

Effective Date: 04/30/2013

Revision: A

LITE-ON DCC

RELEASE

BNS-OD-FC001/A4



LITE-ON TECHNOLOGY CORPORATION.

Property of Lite-On Only



FEATURES

- * High power AlGaAs LED technology
 - * T-1 3/4 Package
 - * 870 nm Wavelength
 - * High speed: 15ns Rise times
 - * Low Forward Voltage
- * Applications
 - Industrial IR Equipments
 - IR Portable Instruments
 - Consumer Electronics
 - (Optical mouse ect)
 - High Speed IR Communications
 - (IR LANs , IR Moldens , IR Dongles , etc)

PACKAGE DIMENSIONS

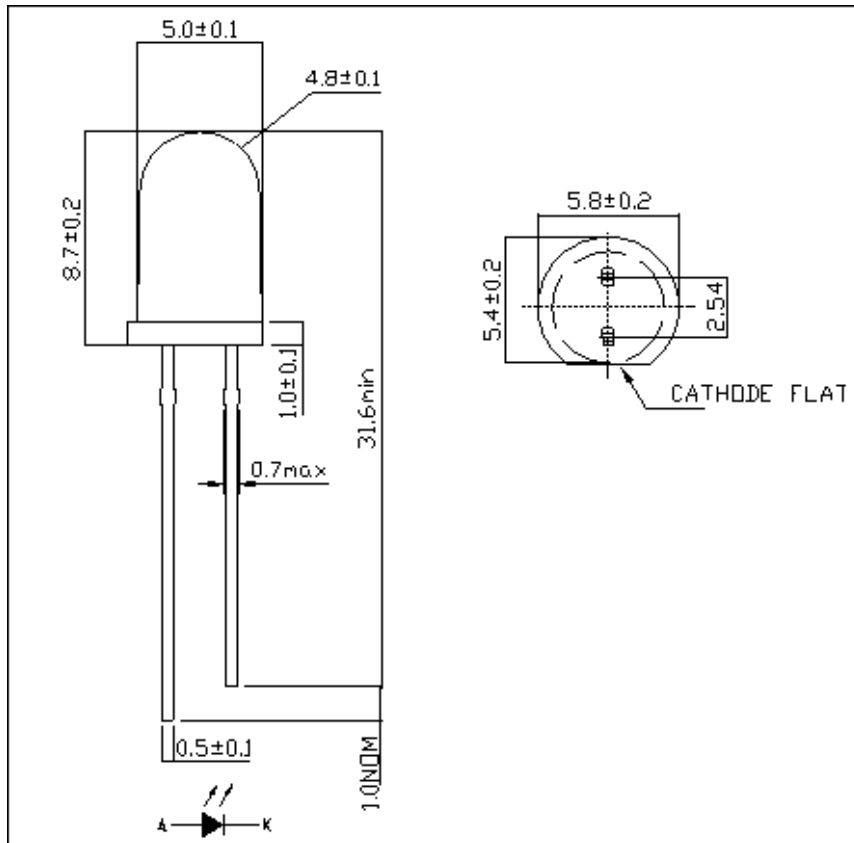

NOTES:

1. All dimensions are in millimeters (inches).
2. Tolerance is ±0.25mm(.010") unless otherwise noted.
3. Protruded resin under flange is 1.5mm(.059") max.
4. Lead spacing is measured where the leads emerge from the package.
5. Specifications are subject to change without notice.



LITE-ON TECHNOLOGY CORPORATION.

Property of Lite-On Only

ABSOLUTE MAXIMUM RATINGS AT TA=25°C

| PARAMETER | Symbol | MIN | MAX | UNIT | Reference |
|--|-------------------|-----|-------------------------|------|-----------|
| Forward Current | I _{FDC} | | 100 | mA | [1],FIG.2 |
| Power Dissipation | P _{DISS} | | 190 | mW | |
| Reverse Voltage | V _R | 5 | | V | IR=100uA |
| Storage Temperature | T _S | -40 | 100 | °C | |
| LED Junction Temperature | T _J | | 110 | °C | |
| Lead Soldering Temperature [1.6mm(.063") From Body] | | | 260 for 5 seconds | °C | |

Notes:

1.Derate as shown in Figure 6.

Recommended Operating Conditions

| PARAMETER | Symbol | MIN | MAX | UNIT | Reference |
|-----------------------|----------------|-----|-----|------|-----------|
| Operating Temperature | T _O | -40 | 70 | °C | |



LITE-ON TECHNOLOGY CORPORATION.

Property of Lite-On Only

ELECTRICAL CHARACTERISTICS AT 25°C

| PARAMETER | Symbol | MIN. | TYP. | MAX. | UNIT | TEST CONDITION | Reference |
|---|-----------------------|------|--------------|------|-------|---|-----------|
| Forward Voltage | V _F | | 1.4 | 1.5 | V | I _{FDC} = 20mA | Fig.2 |
| | | | 1.7 | 1.9 | V | I _{FDC} = 100mA | Fig.3 |
| Forward Voltage Temperature Coefficient | $\Delta V / \Delta T$ | - | -1.5 -1.3 | - | mV/°C | I _{FDC} = 20 mA I _{FDC} = 100 mA | Fig.4 |
| Series Resistance | R _s | - | 4.1 | - | Ohms | I _{FDC} = 100mA | |
| Diode Capacitance | C _o | - | 80 | - | pF | 0 V, 1 MHz | |
| Reverse Voltage | V _R | 3 | 14 | - | V | I _R = 100 μ A | |
| Thermal Resistance, Junction to Ambient | R θ_{ja} | - | 280 | - | °C/W | | |

OPTICAL CHARACTERISTICS AT TA=25°C

| PARAMETER | Symbol | MIN. | TYP. | MAX. | UNIT | Test condition | Reference |
|---|---|----------|-----------|------|-----------|--|-----------|
| Radiant Optical Power | P _O | - | 9 45 | - | mW | I _{FDC} = 20 mA I _{FDC} = 100mA | |
| Radiant On-Axis Intensity | I _E | 17 87 | 36 180 | - | mW /Sr | I _{FDC} = 20 mA I _{FDC} = 100mA | Fig.5 |
| Radiant On-Axis Intensity Temperature Coefficient | $\Delta I_E / \Delta T$ | - | -0.22 | - | %/°C | I _{FDC} = 100mA | |
| Viewing Angle | 2 $\theta_{1/2}$ | - | 26 | - | deg | I _{FDC} = 20mA | Fig.7 |
| Peak Wavelength | λ_{pk} | - | 870 | - | nm | I _{FDC} = 20mA | Fig.1 |
| Peak Wavelength Temperature Coefficient | $\Delta \lambda / \Delta T$ | - | 0.18 | - | nm/°C | I _{FDC} = 20mA | |
| Spectral Width-at FWHM | $\Delta \lambda$ | | 47 52 | - | nm | I _{FDC} = 20 mA I _{FDC} = 100mA | Fig.1 |
| Optical Rise and all Times, 10%-90% | T _r / T _f f _c | | 15 23 | - | Ns MHZ | I _{FDC} = 500 mA Duty Ratio=20% Pulse Width=100ns | |

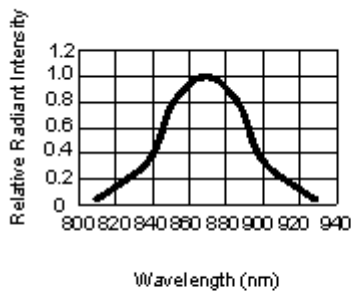

FIG.1 Relative Radiant Intensity VS Wavelength

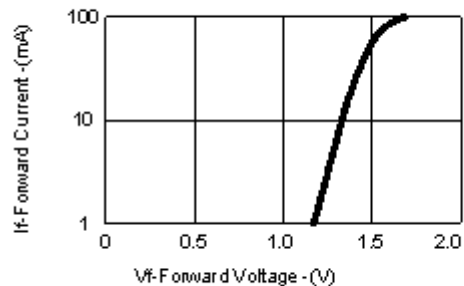

FIG.2 DC Forward Current VS. Forward Voltage

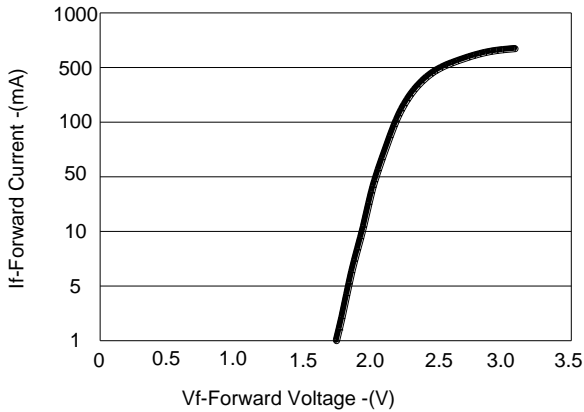

FIG.3 Peak Forward Current VS. Forward Voltage
Forward Current Vs Relative Radiant Intensity

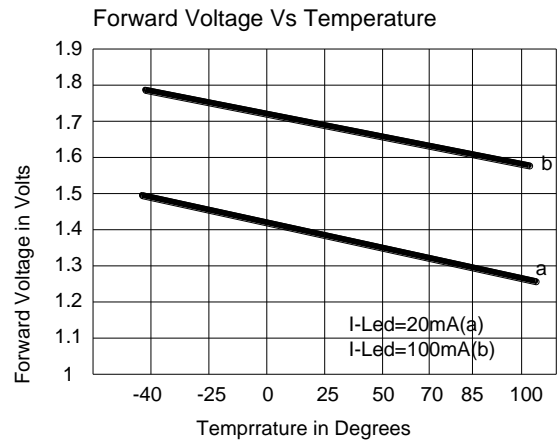

FIG.4 Forward Voltage VS. Ambient Temperature

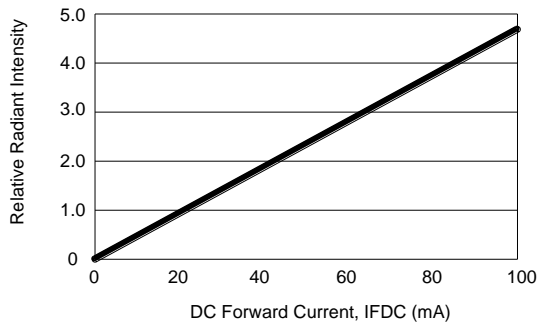

FIG.5 Relative Radiant Intensity vs DC Forward Current

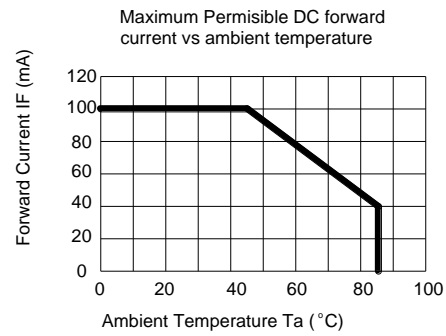

FIG.6 DC FORWARD CURRENT VS. AMBIENT TEMPERATURE DERATED (Based on TJMAX=110°C)

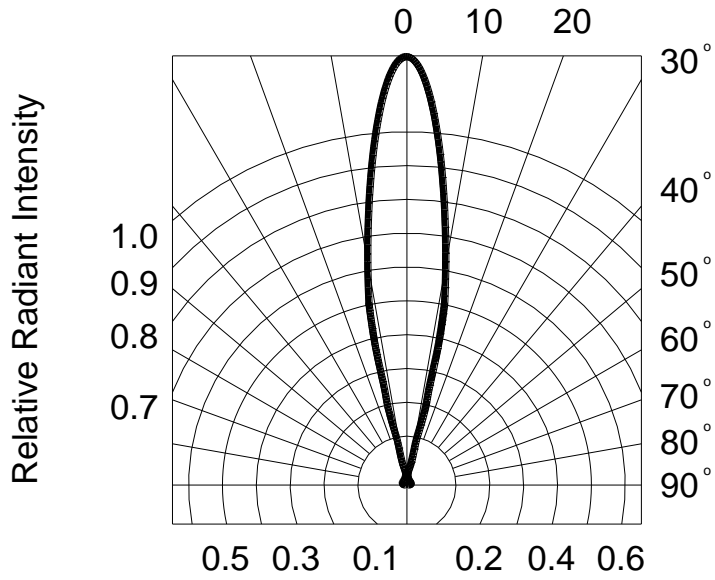

FIG.7 RADIATION DIAGRAM