

### FEATURES

- Very Low Forward Voltage (1.15V)
- Very Fast Recovery Times (50nSec)
- Small Size
- Convenient Package

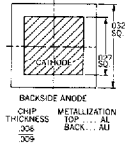

### DESCRIPTION

The UES1104 series is specifically designed for operation in power switching circuits operating at frequencies of at least 20 KHz.

### ABSOLUTE MAXIMUM RATINGS

Peak Inverse Voltage, UES1104	.....	200V
Peak Inverse Voltage, UES1105	.....	300V
Peak Inverse Voltage, UES1106	.....	400V
Maximum Average DC Output Current, $I_O$		
@ $T_A = 25^\circ\text{C}$ (Free Air)	.....	1A
@ $T_L = 50^\circ\text{C}$ , $L = \frac{3}{8}"$	.....	2A
Surge Current, 8.3mSec	.....	20A
Thermal Resistance @ $L = \frac{3}{8}"$	.....	38°C/W
Operating and Storage Temperature Range	.....	-55°C to +150°C

### MECHANICAL SPECIFICATIONS

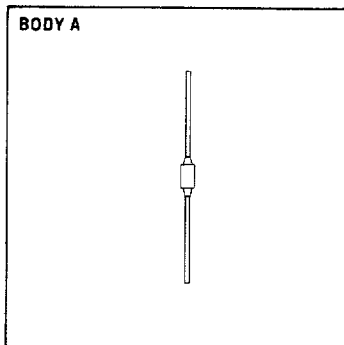
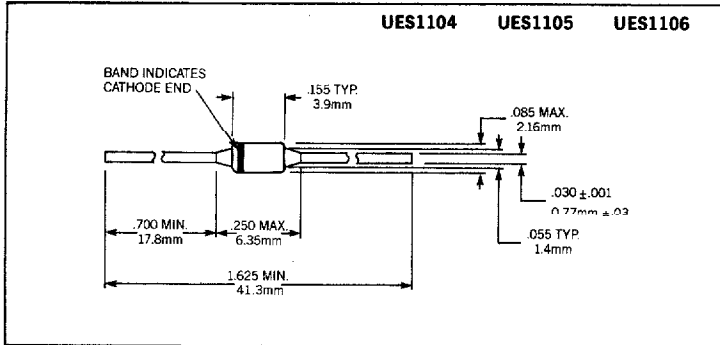

THESE DEVICES ALSO AVAILABLE IN SURFACE MOUNT PACKAGE. SEE SECTION 10

**ELECTRICAL SPECIFICATIONS**

Type	PIV	Maximum Forward Voltage		Maximum Reverse Current		Maximum Reverse Recovery Time*
		$T_J = 25^\circ\text{C}$	$T_J = 100^\circ\text{C}$	@ PIV, $T_J = 25^\circ\text{C}$	$T_J = 100^\circ\text{C}$	
UES1104/1104HR	200V	1.25V @ 1A tp = 300 $\mu$ S	1.15V @ 1A tp = 300 $\mu$ S	10 $\mu$ A	200 $\mu$ A	50nS
UES1105/1105HR	300V					
UES1106/1106HR	400V					

\* Measured in circuit  $I_F = 0.5A$ ,  $I_R = 1A$ ,  $I_{REC} = 0.25A$

**Output Current vs. Lead Temperature**

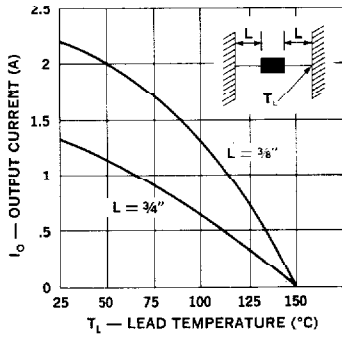

**Peak Output Current vs. Lead Temperature**

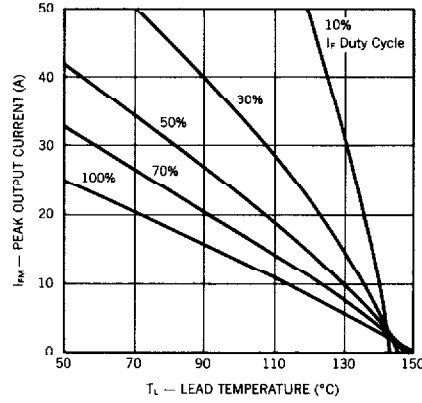

**Typical Forward Current vs. Forward Voltage**

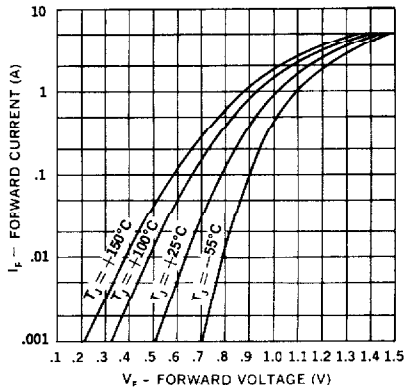

**Typical Reverse Current vs. Reverse Voltage**

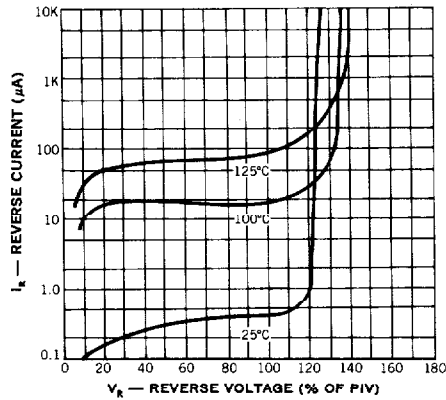

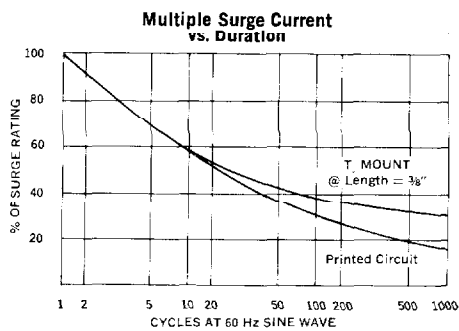
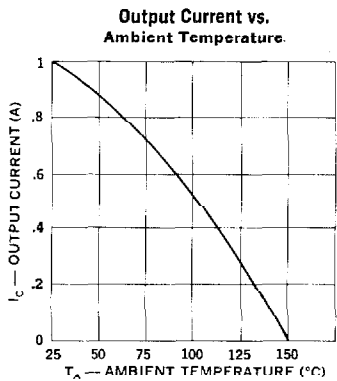

### Reverse-Recovery Circuit

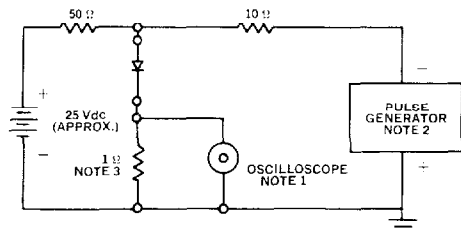

- NOTES:**
1. Oscilloscope: Rise time  $\leq 3$ ns; input impedance =  $50\Omega$ .
  2. Pulse Generator: Rise time  $\leq 8$ ns; source impedance  $10\Omega$ .
  3. Current viewing resistor, non-inductive, coaxial recommended.

• OPTIONAL HIGH RELIABILITY (HR2) SCREENING (See 1N6620-1N6625)