

# AN11007

## Single stage 5-6 GHz WLAN LNA with BFU730F

Rev. 2 — 20 November 2012

Application note

### document information

Info	Content
<b>Keywords</b>	BFU730F, LNA, 802.11a & 802.11n MIMO WLAN
<b>Abstract</b>	<p>The document provides circuit, layout, BOM and performance information on 5-6 GHz band LNA equipped with NXP's BFU730F wide band transistor.</p> <p>This Application note is related to evaluation board OM7691/BFU730F,598 12nC 934065628598</p>



## Revision history

Rev	Date	Description
1	20110104	Initial document.
2	20121120	Chapter added about switching time.

## Contact information

For additional information, please visit: <http://www.nxp.com>

For sales office addresses, please send an email to: [salesaddresses@nxp.com](mailto:salesaddresses@nxp.com)

## 1. Introduction

The BFU730F is a discrete HBT that is produced using NXP Semiconductors' advanced 110 GHz  $f_T$  SiGe:C BiCmos process. SiGe:C is a normal silicon germanium process with the addition of Carbon in the base layer of the NPN transistor. The presence of carbon in the base layer suppresses the boron diffusion during wafer processing. This allows steeper and narrower SiGe HBT base and a heavier doped base. As a result, lower base resistance, lower noise and higher cut off frequency can be achieved.

The BFU730F is one of a series of transistors made in SiGe:C.

BFU710F; BFU760 and BFU790 are the other types, BFU710 is intended for ultra low current applications. The BFU760F and BFU790F are high current types and are intended for application where linearity is key.

The BFU7XXF are ideal in all kind of applications where cost matters. It also gives design flexibility.

## 2. Requirements and design of the 5-6 GHz WLAN LNA

The circuit shown in this application note is intended to demonstrate the performance of the BFU730 in a 5-6 GHz LNA for e.g. 802.11 & 802.11n "MIMO" WLAN applications. Key requirements for this application as are:

- NF
- Gain
- Turn on turn of time
- Linearity.

The target for this circuit is listed in table 1.

**Table 1. Target spec.**  
*Target specification of the 5-6GHz LNA.*

Vcc	Icc	NF	Gain	IRL	ORL
3	10	<2	>15	>10	>10
V	mA	dB	dB	dB	dB

## 3. Design

The 5-6 GHz LNA consists of one stage BFU730F amplifier. For this amplifier 12 external components are used, for matching, biasing and decoupling.

The design has been conducted using Agilent's Advanced Design System (ADS). The 2D EM Momentum tool has been used to co simulate the PCB see [Fig 1](#). Results are given in paragraph [4.5](#).

The LNA shows a Gain of 14 dB @5.5 GHz, NF of 1.3 dB, with only 10 mA it shows a high input P1 dB compression of -7.5 dBm, as well as a input IP3 of +10 dBm.

Finally the LNA is unconditional stable 10 MHz-20 GHz.

3.1 BFU730F 5-6 GHz-ADS Simulation circuit

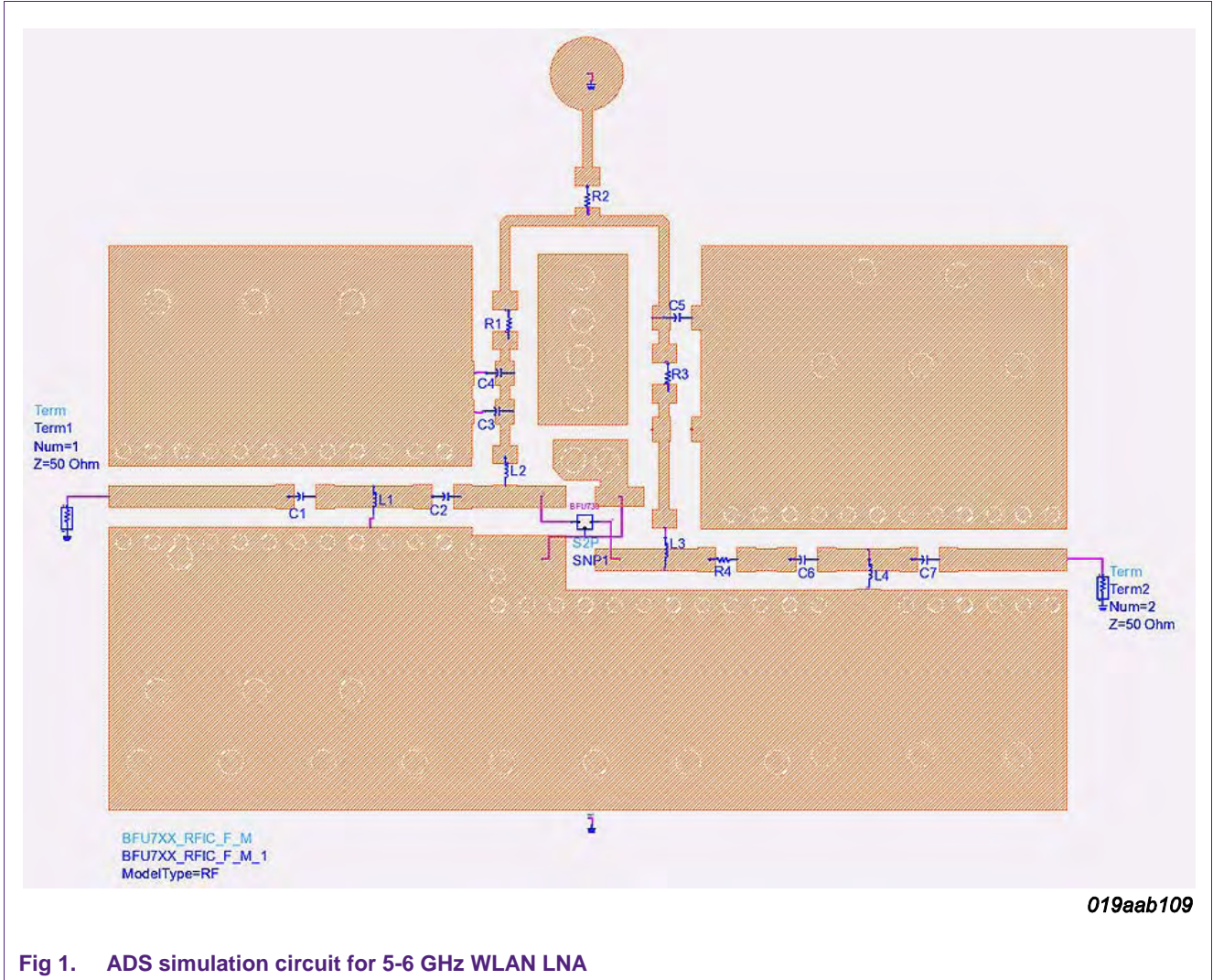

Fig 1. ADS simulation circuit for 5-6 GHz WLAN LNA

3.2 BFU730F 5-6 GHz - ADS Gain and match simulation results

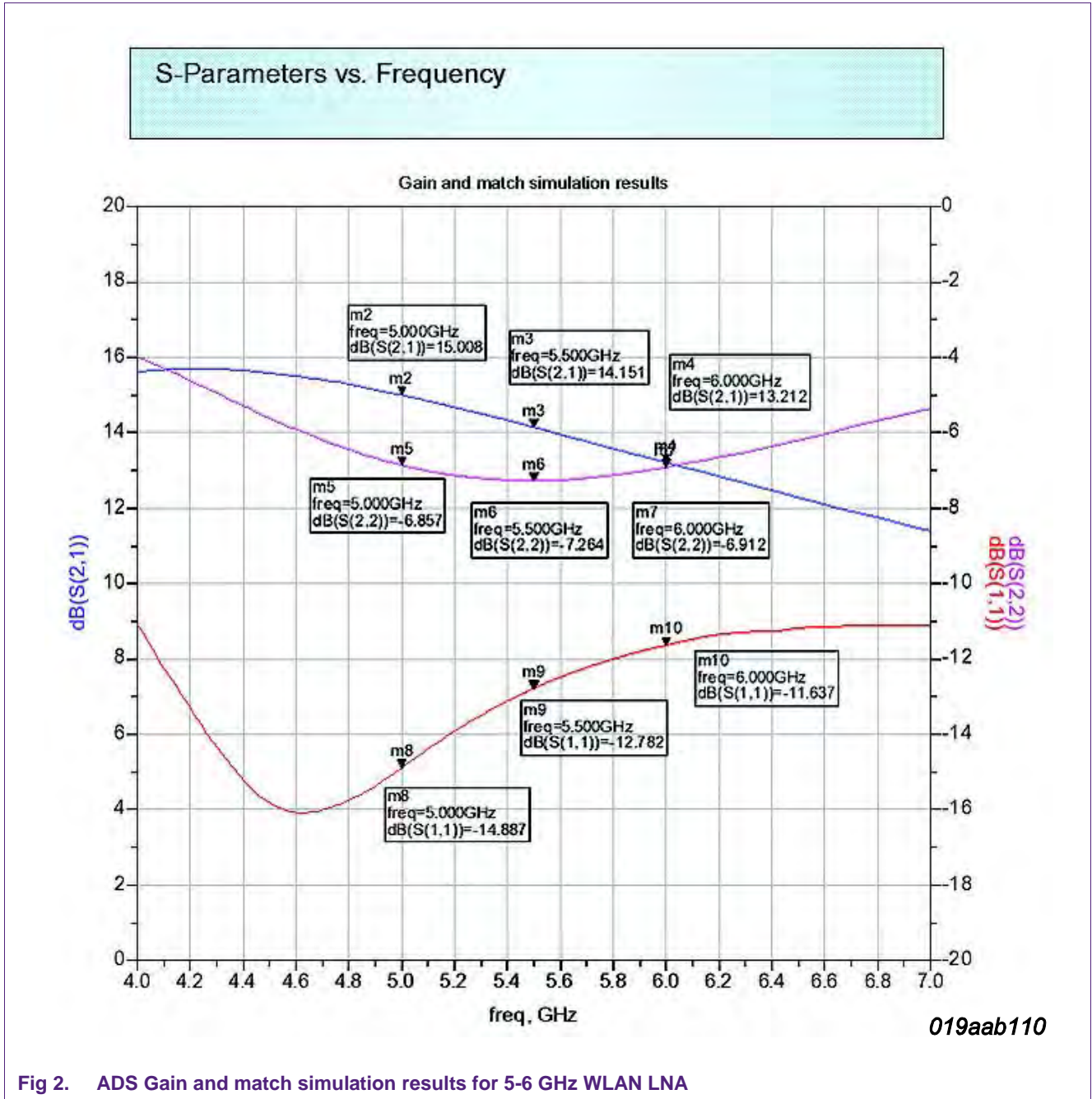
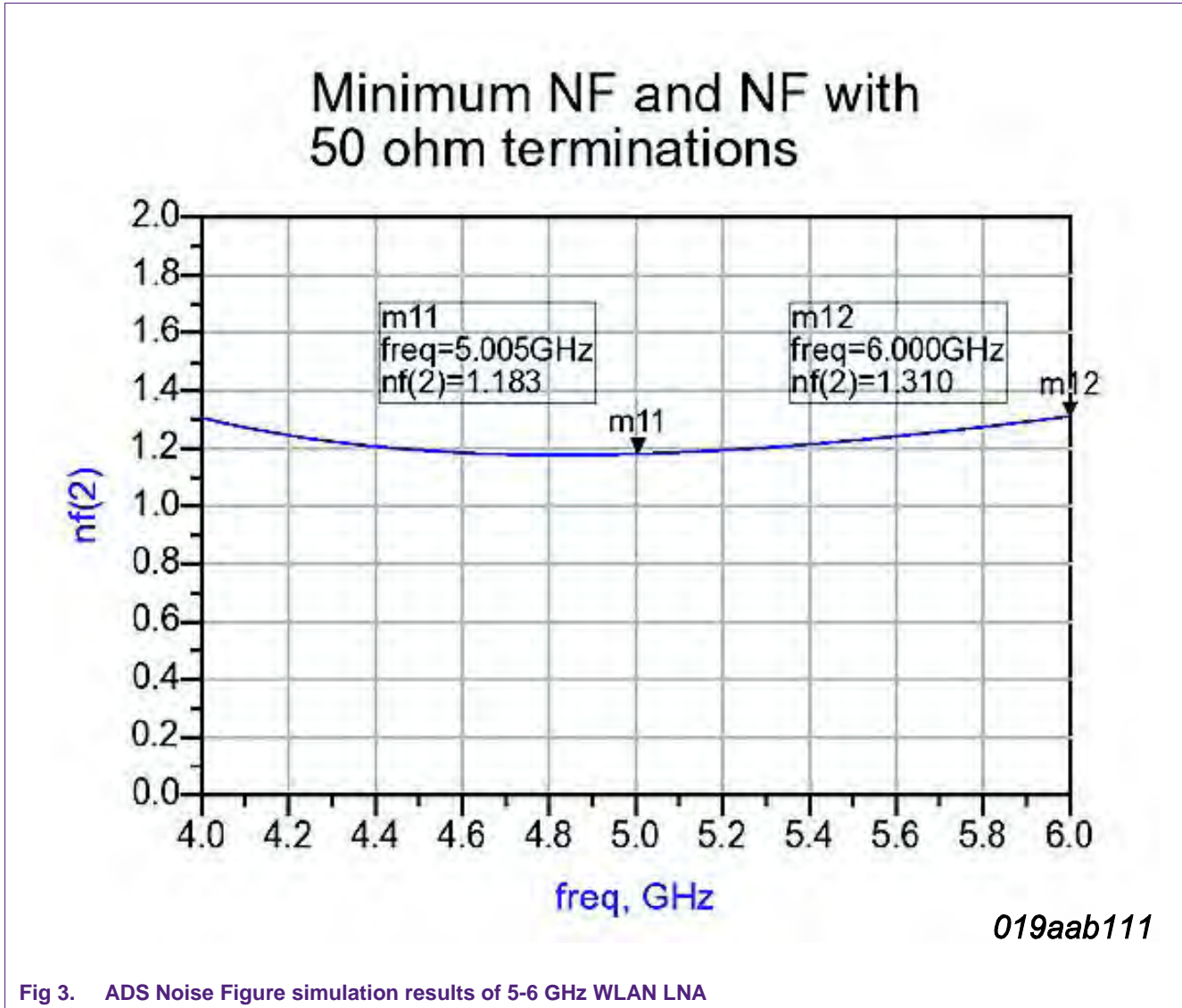

Fig 2. ADS Gain and match simulation results for 5-6 GHz WLAN LNA

3.3 BFU730F 5-6 GHz-ADS NF simulation



3.4 BFU730F 5-6 GHz-ADS Stability simulation

If either  $\mu_{source}$  or  $\mu_{load}$  is  $>1$ , the circuit is unconditionally stable.

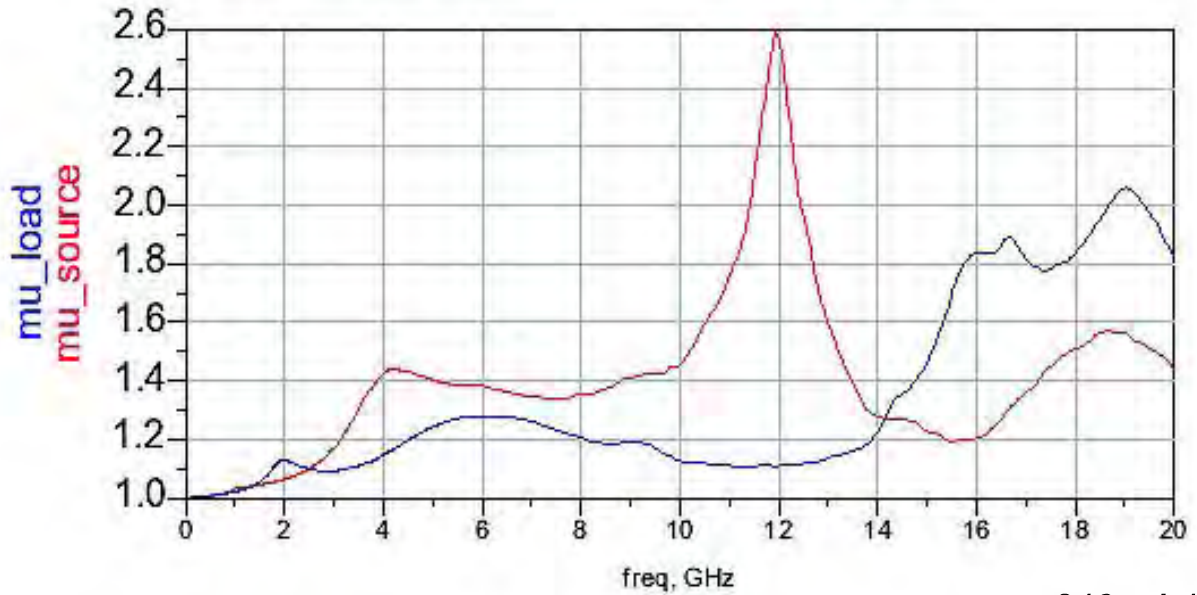

019aab112

As  $K \geq 1$  and  $\mu \geq 1$ , the LNA is unconditionally stable for the whole frequency band

Fig 4. ADS stability simulation results of 5-6 GHz WLAN LNA

## 4. Implementation

### 4.1 Schematic

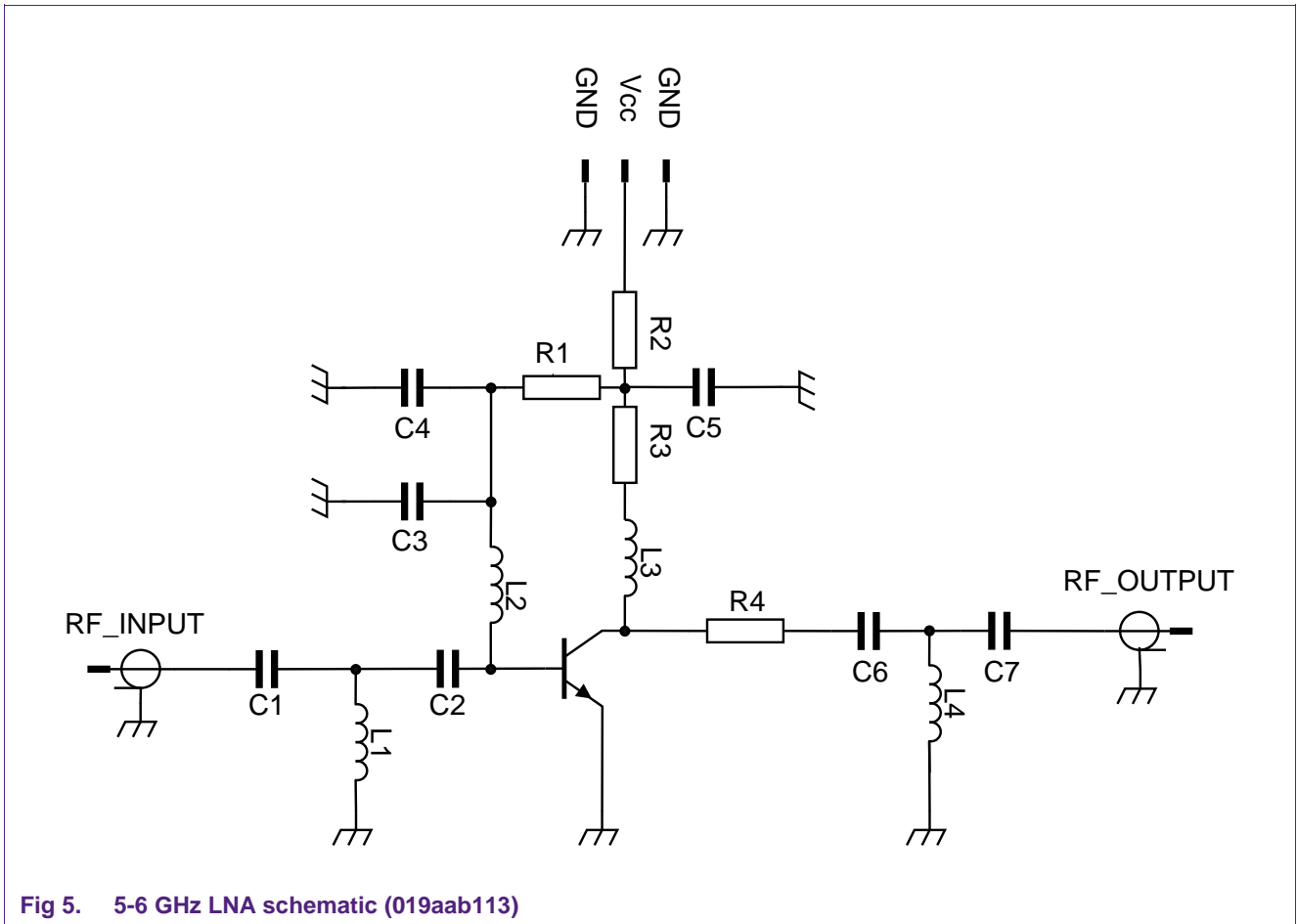

Fig 5. 5-6 GHz LNA schematic (019aab113)



4.2 Layout and assembly

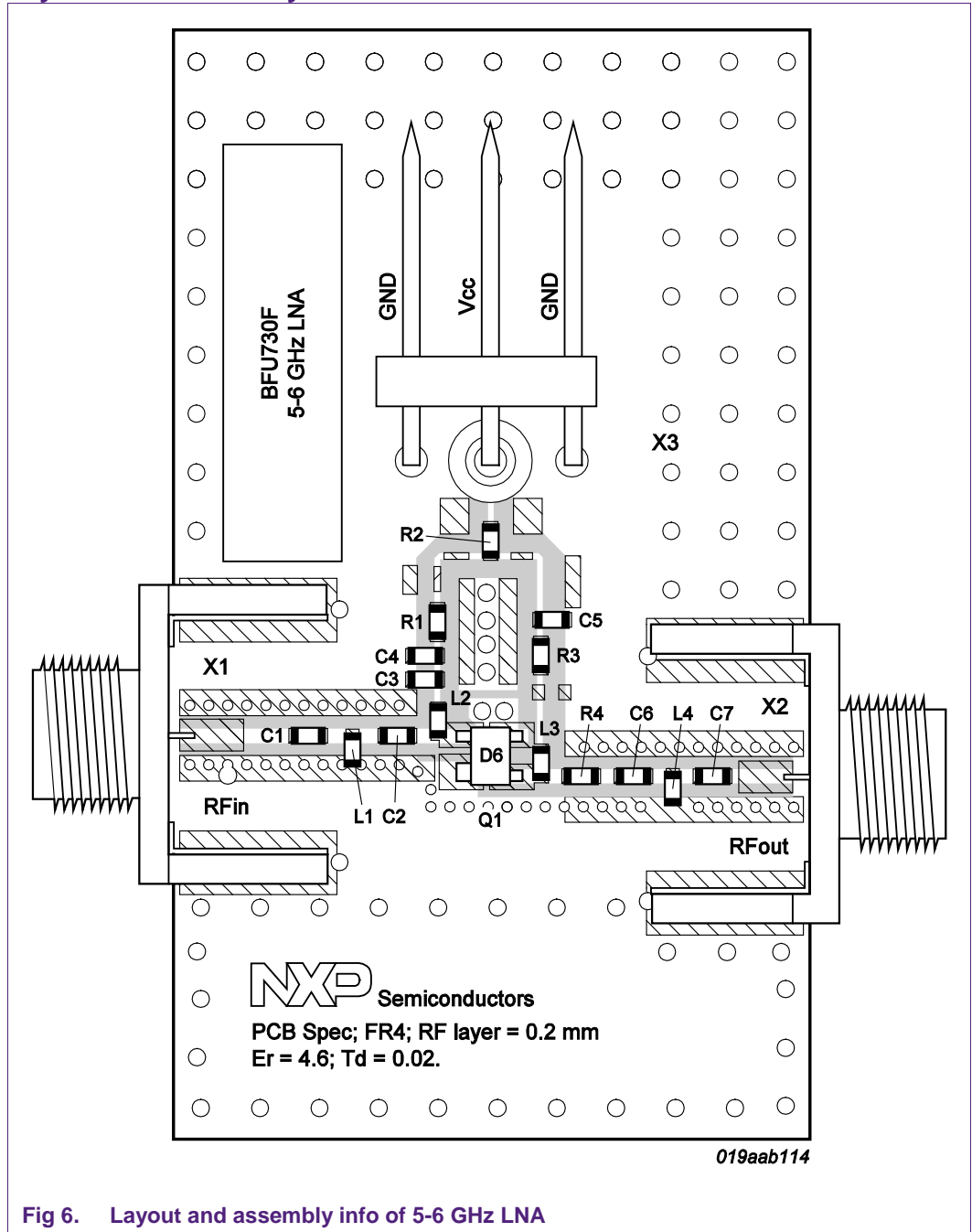

Fig 6. Layout and assembly info of 5-6 GHz LNA

**Table 2. Bill of materials**

Designator	Description	Size	Value	Type	Note
Q1	BFU730F	2X2 mm		NXP Semiconductors	HBT
PCB		20X35 mm			
C1,C7	Capacitor	0402	3.9 pF	MurataGRM1555	input/output match
C2,C6	Capacitor	0402	0.75 pF	MurataGRM1555	input/output match
C3	Capacitor	0402	15 nF	MurataGRM1555	
C4	Capacitor	0402	1.5 pF	MurataGRM1555	
C5	Capacitor	0402	1.5 pF	MurataGRM1555	
L1,L4	Inductor	0402	1.5 nH	Murata LQP15	input/output match
L2	Inductor	0402	9.1 nH	Murata LQW15	input match
L3	Inductor	0402	5.1 nH	Murata LQW15	output match
R1	Resistor	0402	37 K		Bias Setting
R2	Resistor	0402	100 Ohm		Bias Setting Hfe and Temp spread cancellation
R3	Resistor	0402	10 Ohm		Stability
R4	Resistor	0402	0 Ohm		NA
X1,X2	SMA RF connector	-		Johnson, End launch SMA 142-0701-841	RF input/ RF output
X3	DC header	-		Molex, PCB header, Right Angle, 1 row, 3 way 90121-0763	Bias connector

### 4.3 PCB layout.

A good PCB Layout is an essential part of an RF circuit design. The EVB of the BFU730 can serve as a guideline for laying out a board using either the BFU730 or one of the other SiGe.C HBTs in the SOT343F package. Use controlled impedance lines for all high frequency inputs and outputs. Bypass  $V_{CC}$  with decoupling capacitors, preferable located as close as possible to the device. For long bias lines it may be necessary to add decoupling capacitors along the line further away from the device. Proper grounding the emitters is also essential for the performance. Either connect the emitters directly to the ground plane ore through vias, or do both.

The material that has been used for the EVB is FR4 using the stack shown in [Fig 7](#).

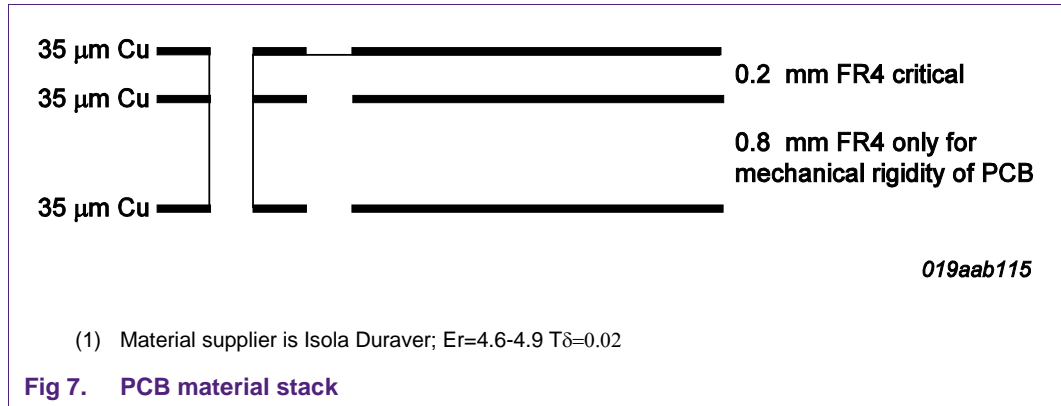

4.4 LNA View

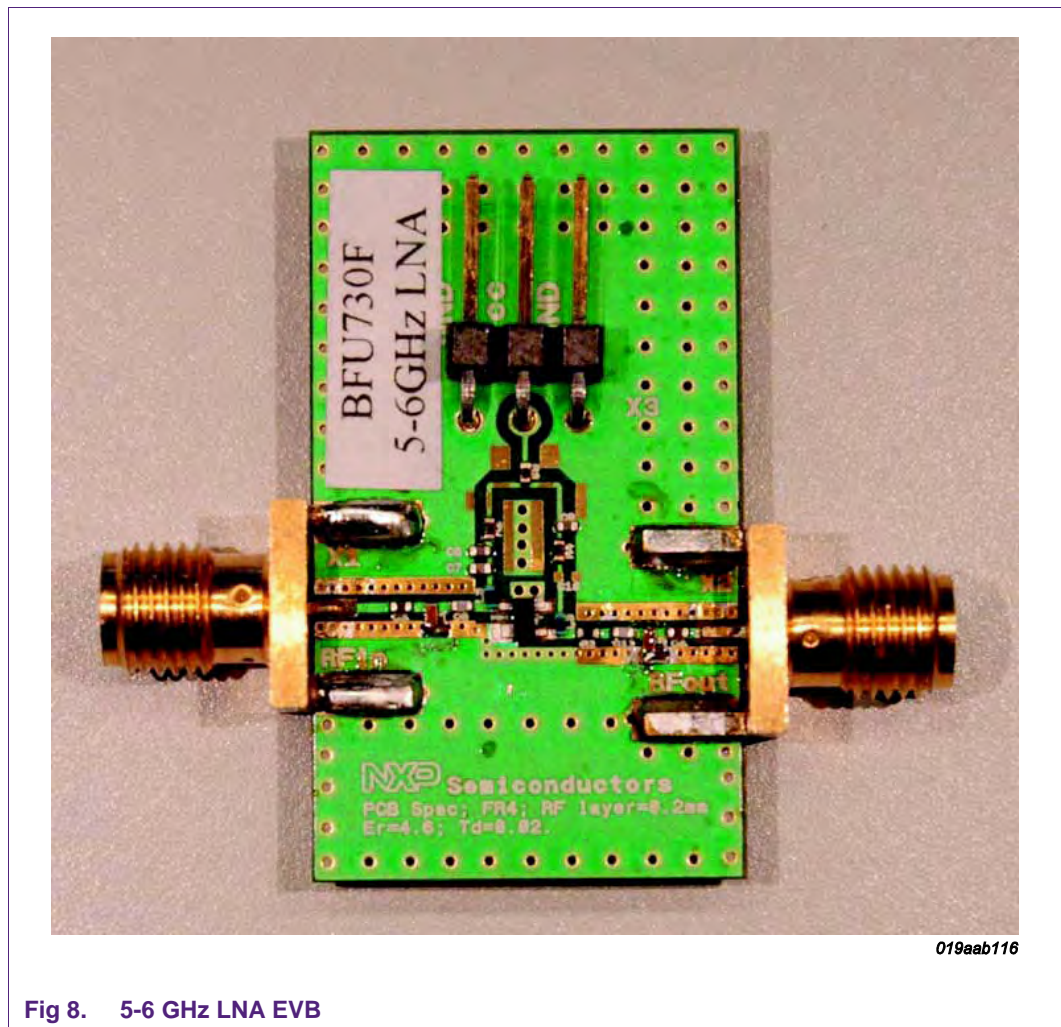

## 4.5 Measurement results

**Table 3. Typical measurement results measured on the evaluation board.**

*Temp=25 °C, frequency is 5.5 GHz unless otherwise specified.*

Parameter	Symbol	Value	Unit	Remarks
Supply Voltage	$V_{cc}$	3	V	
Supply Current	$I_{cc}$	10	mA	
Noise Figure	NF <sup>[1]</sup>	1.3	dB	
Power Gain	5.0 GHz	15.8	dB	
	5.5 GHz	14.7	dB	
	6.0 GHz	13.7	dB	
Input return Loss	IRL	12	dB	
Output return Loss	ORL	13.5	dB	
Input 1 dB Gain compression Point	$P_{i1dB}$	-7.5	dBm	
Output 1 dB Gain compression Point	$P_{o1dB}$	+6.5	dBm	
Input third order intercept point	$IP3_i$	+10	dBm	
Output third order intercept point	$IP3_o$	+24	dBm	
Power settling time	$T_{on}$	160	$\mu$ s	
	$T_{off}$	28	ns	

[1] The NF and Gain figures are being measured at the SMA connectors of the evaluation board, so the losses of the connectors and the PCB of approximately 0.1dB are not subtracted.

### 4.5.1 Faster switching time. <1 $\mu$ s

If no switching speed is required in the application, the recommendation is to keep the BOM as is presented in this application not. However if the LNA is applied in e.g. a WLAN application where power settling time is required to be <1  $\mu$ s, the value of C3 should be changed to 67pF. This will result in a  $T_{on}$  power settling time of 890ns and the  $T_{off}$  power settling time stays 28ns. However this change in capacitor values will result in about 5dB of degradation of the IP3 figures reported in [Table 3](#)

4.5.2 Gain and match – typical results

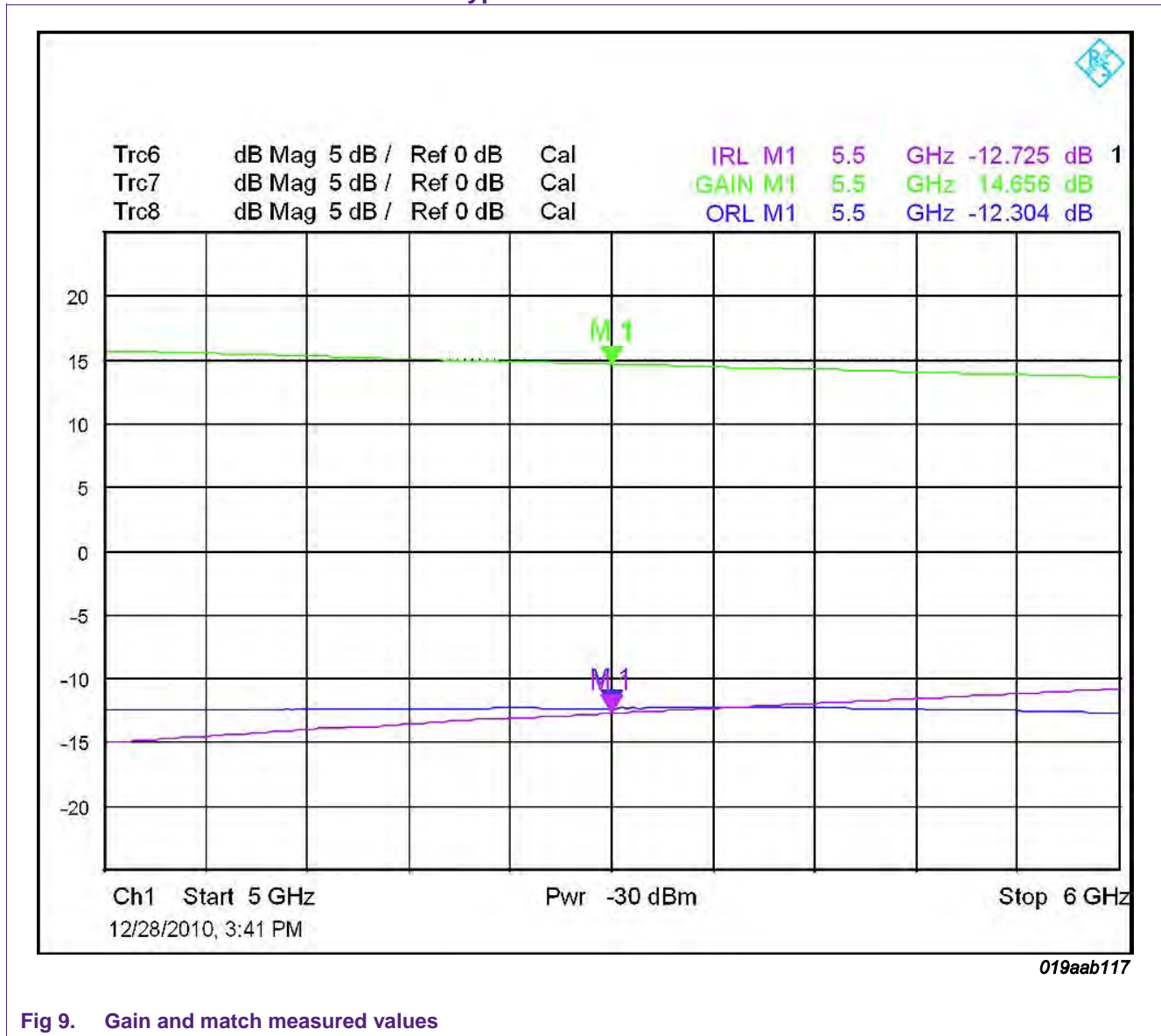

Fig 9. Gain and match measured values

4.5.3 NF and Gain- typical values



4.5.4 Stability

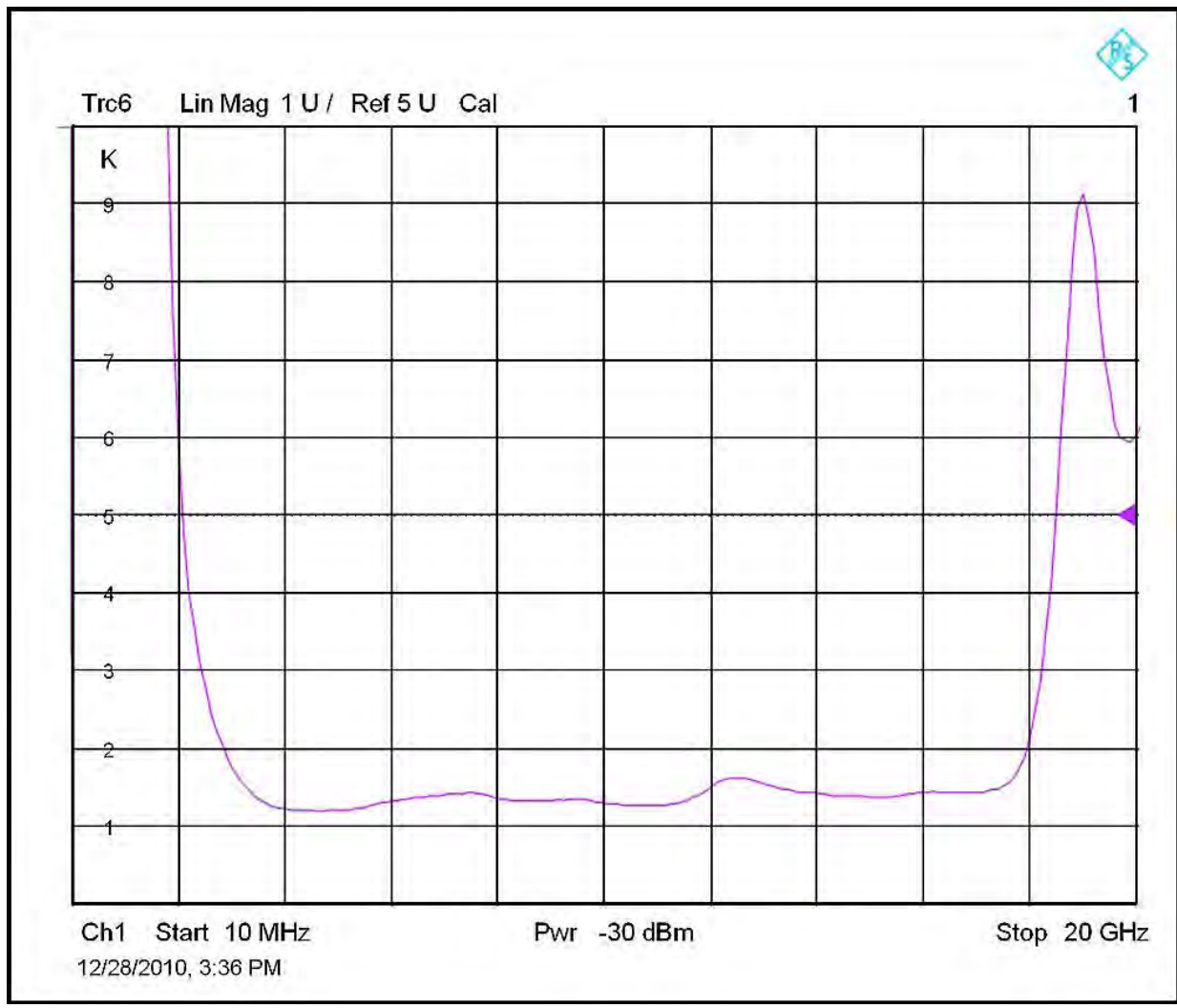
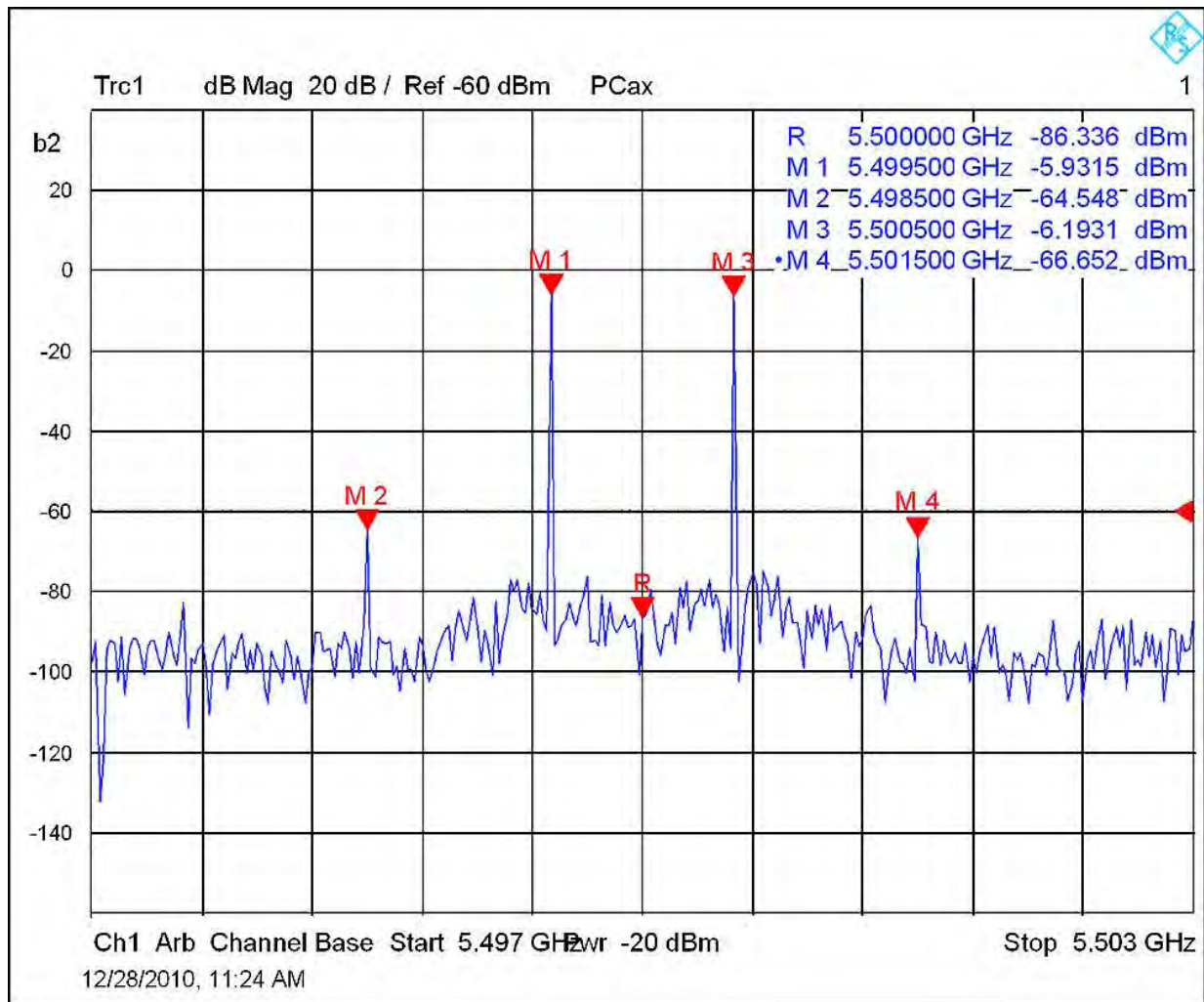

Fig 11. Stability typical measurement results





4.5.6 Linearity IP3 – typical values



(1)  $IP3_o = -6.2 + ((66.7 - 6.2) / 2) = +24$  dBm;  $IP3_i = -20$  dBm +  $60.5 / 2 = -20 + 30.25 = +10.25$

Fig 13. IM3 - typical values

4.5.7 Power settling time

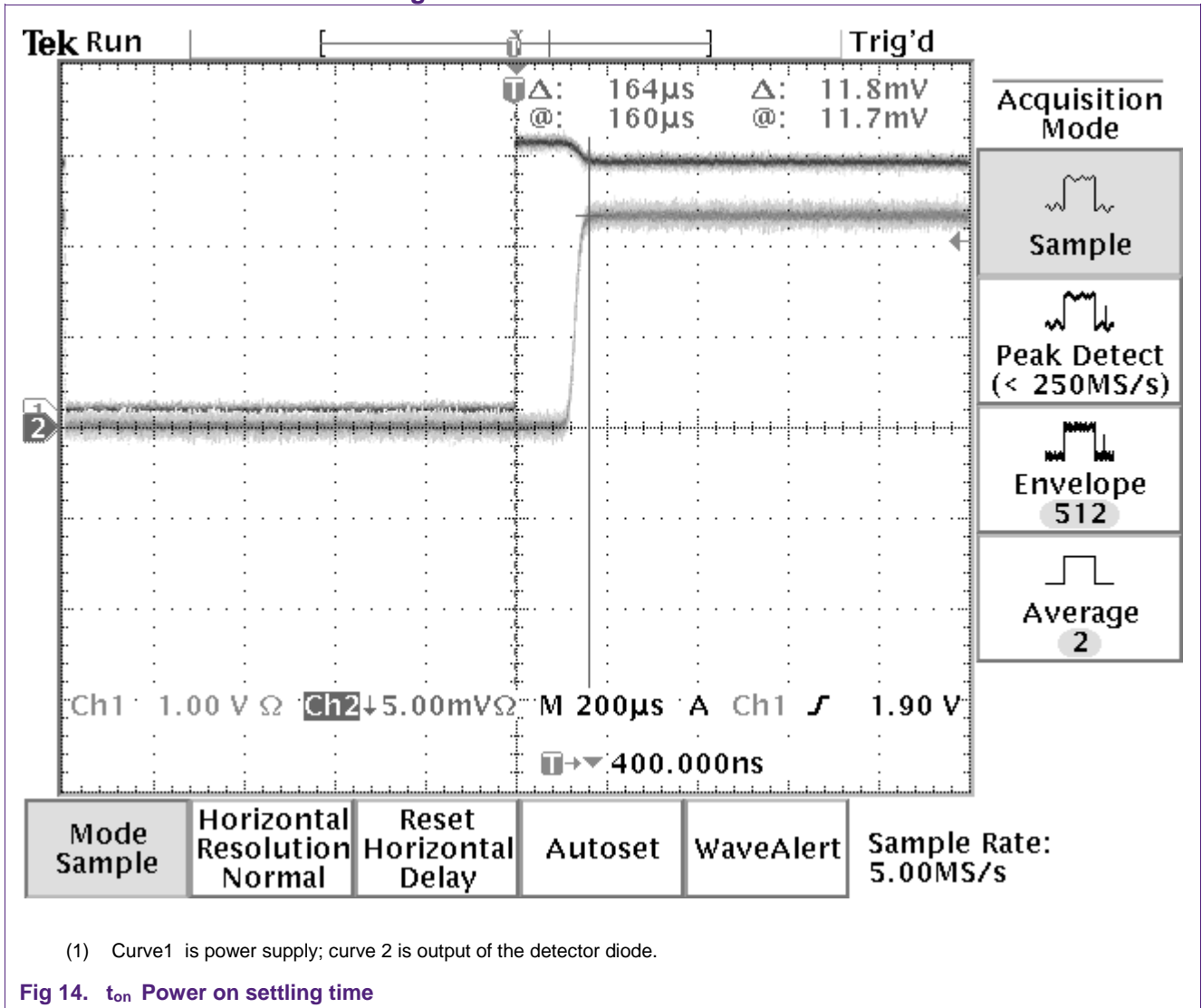



## 5. Legal information

### 5.1 Definitions

**Draft** — The document is a draft version only. The content is still under internal review and subject to formal approval, which may result in modifications or additions. NXP Semiconductors does not give any representations or warranties as to the accuracy or completeness of information included herein and shall have no liability for the consequences of use of such information.

### 5.2 Disclaimers

**Limited warranty and liability** — Information in this document is believed to be accurate and reliable. However, NXP Semiconductors does not give any representations or warranties, expressed or implied, as to the accuracy or completeness of such information and shall have no liability for the consequences of use of such information.

In no event shall NXP Semiconductors be liable for any indirect, incidental, punitive, special or consequential damages (including - without limitation - lost profits, lost savings, business interruption, costs related to the removal or replacement of any products or rework charges) whether or not such damages are based on tort (including negligence), warranty, breach of contract or any other legal theory.

Notwithstanding any damages that customer might incur for any reason whatsoever, NXP Semiconductors' aggregate and cumulative liability towards customer for the products described herein shall be limited in accordance with the Terms and conditions of commercial sale of NXP Semiconductors.

**Right to make changes** — NXP Semiconductors reserves the right to make changes to information published in this document, including without limitation specifications and product descriptions, at any time and without notice. This document supersedes and replaces all information supplied prior to the publication hereof.

**Suitability for use** — NXP Semiconductors products are not designed, authorized or warranted to be suitable for use in life support, life-critical or safety-critical systems or equipment, nor in applications where failure or malfunction of an NXP Semiconductors product can reasonably be expected to result in personal injury, death or severe property or environmental damage. NXP Semiconductors accepts no liability for inclusion and/or use of NXP Semiconductors products in such equipment or applications and therefore such inclusion and/or use is at the customer's own risk.

**Applications** — Applications that are described herein for any of these products are for illustrative purposes only. NXP Semiconductors makes no representation or warranty that such applications will be suitable for the specified use without further testing or modification.

Customers are responsible for the design and operation of their applications and products using NXP Semiconductors products, and NXP Semiconductors accepts no liability for any assistance with applications or customer product design. It is customer's sole responsibility to determine whether the NXP Semiconductors product is suitable and fit for the

customer's applications and products planned, as well as for the planned application and use of customer's third party customer(s). Customers should provide appropriate design and operating safeguards to minimize the risks associated with their applications and products.

NXP Semiconductors does not accept any liability related to any default, damage, costs or problem which is based on any weakness or default in the customer's applications or products, or the application or use by customer's third party customer(s). Customer is responsible for doing all necessary testing for the customer's applications and products using NXP Semiconductors products in order to avoid a default of the applications and the products or of the application or use by customer's third party customer(s). NXP does not accept any liability in this respect.

**Export control** — This document as well as the item(s) described herein may be subject to export control regulations. Export might require a prior authorization from national authorities.

**Evaluation products** — This product is provided on an "as is" and "with all faults" basis for evaluation purposes only. NXP Semiconductors, its affiliates and their suppliers expressly disclaim all warranties, whether express, implied or statutory, including but not limited to the implied warranties of non-infringement, merchantability and fitness for a particular purpose. The entire risk as to the quality, or arising out of the use or performance, of this product remains with customer.

In no event shall NXP Semiconductors, its affiliates or their suppliers be liable to customer for any special, indirect, consequential, punitive or incidental damages (including without limitation damages for loss of business, business interruption, loss of use, loss of data or information, and the like) arising out of the use of or inability to use the product, whether or not based on tort (including negligence), strict liability, breach of contract, breach of warranty or any other theory, even if advised of the possibility of such damages.

Notwithstanding any damages that customer might incur for any reason whatsoever (including without limitation, all damages referenced above and all direct or general damages), the entire liability of NXP Semiconductors, its affiliates and their suppliers and customer's exclusive remedy for all of the foregoing shall be limited to actual damages incurred by customer based on reasonable reliance up to the greater of the amount actually paid by customer for the product or five dollars (US\$5.00). The foregoing limitations, exclusions and disclaimers shall apply to the maximum extent permitted by applicable law, even if any remedy fails of its essential purpose.

### 5.3 Trademarks

Notice: All referenced brands, product names, service names and trademarks are property of their respective owners.

## 6. List of figures

---

Fig 1.	ADS simulation circuit for 5-6 GHz WLAN LNA	4
Fig 2.	ADS Gain and match simulation results for 5-6 GHz WLAN LNA .....	5
Fig 3.	ADS Noise Figure simulation results of 5-6 GHz WLAN LNA.....	6
Fig 4.	ADS stability simulation results of 5-6 GHz WLAN LNA.....	7
Fig 5.	5-6 GHz LNA schematic (019aab113) .....	8
Fig 6.	Layout and assembly info of 5-6 GHz LNA .....	9
Fig 7.	PCB material stack .....	11
Fig 8.	5-6 GHz LNA EVB .....	11
Fig 9.	Gain and match measured values .....	13
Fig 10.	Typical NF curve .....	14
Fig 11.	Stability typical measurement results.....	15
Fig 12.	Typical 1 dB compression point curve. ....	16
Fig 13.	IM3 - typical values .....	17
Fig 14.	$t_{on}$ Power on settling time .....	18
Fig 15.	$t_{off}$ Power off settling time .....	19

7. List of tables

---

Table 1. Target spec..... 3  
Table 2. Bill of materials..... 10  
Table 3. Typical measurement results measured on the  
evaluation board. .... 12

## 8. Contents

---

<b>1.</b>	<b>Introduction .....</b>	<b>3</b>
<b>2.</b>	<b>Requirements and design of the 5-6 GHz WLAN LNA .....</b>	<b>3</b>
<b>3.</b>	<b>Design .....</b>	<b>3</b>
3.1	BFU730F 5-6 GHz-ADS Simulation circuit.....	4
3.2	BFU730F 5-6 GHz - ADS Gain and match simulation results .....	5
3.3	BFU730F 5-6 GHz-ADS NF simulation .....	6
3.4	BFU730F 5-6 GHz-ADS Stability simulation .....	7
<b>4.</b>	<b>Implementation .....</b>	<b>8</b>
4.1	Schematic .....	8
4.2	Layout and assembly .....	9
4.3	PCB layout .....	10
4.4	LNA View .....	11
4.5	Measurement results.....	12
4.5.1	Faster switching time. <1 $\mu$ s.....	12
4.5.2	Gain and match – typical results .....	13
4.5.3	NF and Gain- typical values .....	14
4.5.4	Stability .....	15
4.5.5	1dB compression point- typical values. ....	16
4.5.6	Linearity IP3 – typical values.....	17
4.5.7	Power settling time.....	18
<b>5.</b>	<b>Legal information .....</b>	<b>20</b>
5.1	Definitions .....	20
5.2	Disclaimers.....	20
5.3	Trademarks .....	20
<b>6.</b>	<b>List of figures.....</b>	<b>21</b>
<b>7.</b>	<b>List of tables .....</b>	<b>22</b>
<b>8.</b>	<b>Contents.....</b>	<b>23</b>

---

Please be aware that important notices concerning this document and the product(s) described herein, have been included in the section 'Legal information'.

---

© NXP B.V. 2012.

All rights reserved.

For more information, please visit: <http://www.nxp.com>  
 For sales office addresses, please send an email to: [salesaddresses@nxp.com](mailto:salesaddresses@nxp.com)

Date of release: 20 November 2012

Document identifier: AN11007