

# F2300 RFI Filters



## Features:

- Effective Protection from Pulsed, Intermittent or Continuous RFI for FCC "A" Applications
- High-Performance Low-Leakage Filter in Low Profile Package with Integral IEC Connector
- Increased Inductance and Line-to-Line Capacitance Provide Enhanced Common Mode and Differential Mode Attenuation

## F2300CA Simplified Schematic

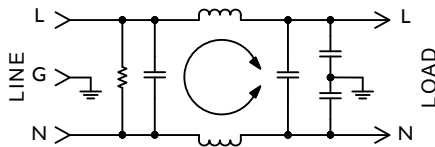

## F2300CA (6Amp) Dimensions

Refer to Page 58  
for Standard  
Mounting Cutouts

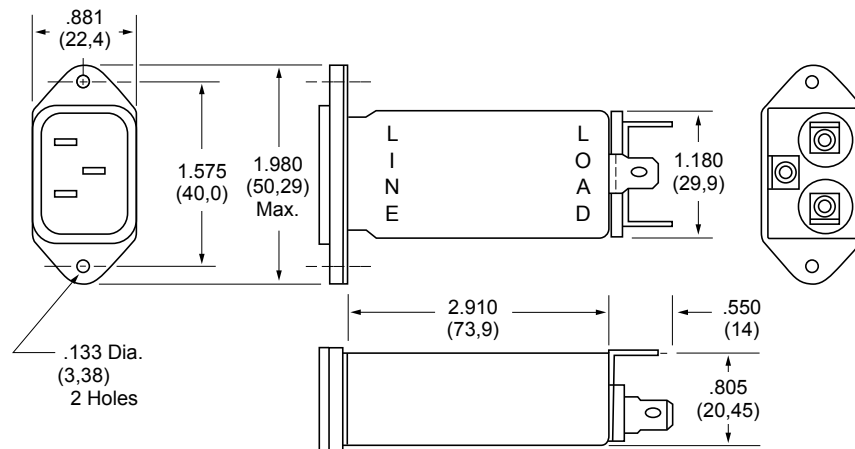

## Specifications:

**Rated Voltage:** 250VAC Maximum - 50/60 Hz

**Rated Current:** 115VAC 250VAC  
6A 6A

**Current Overload:** 6X for 8 seconds

### Hi-Pot Test (1 min):

Line to Ground 1500VAC  
Line to Line 1768VDC

**Insulation Resistance:**  $9 \times 10^9 \Omega$  at 100VDC

**Ambient Temperature:** 40°C Max at rated current

**Humidity Range:** 0% to 95% R.H.

### Termination:

A: QC – Quick Connect  
C: IEC Receptacle

### Maximum Leakage Current:

Each Line to Ground **F2300**  
115VAC, 60Hz: 0.25mA  
250VAC, 50Hz: 0.40mA

### Agency Approvals:



Nominal Current Rating	Part Number	Termination Line/Load	MINIMUM INSERTION LOSS - dB (50 ohm Circuit)						
			MODE	Frequency - MHz					
6A	F2300CA06	IEC/QC	Common Differential	.15	.50	1.0	5.0	10	30
								25 12	37 30

NOTE: Other combinations of terminals may be specified on special order.

Dimensions are in inches and millimeters unless otherwise specified. Values in parentheses are metric equivalents.



**Curtis Industries**  
A Division of Powers Holdings, Inc.

1-800-657-0853

# Standard Mounting Cutouts

## F2199CA, F2200CA, F2300CA, F2400CA, F2500CA, F2700CA, F3100CA, F3200CA, F3400CA, F3500CA

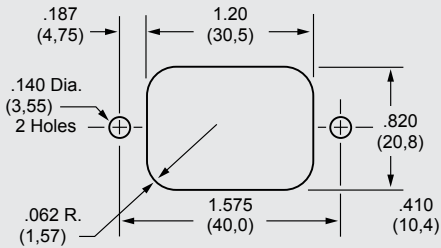

Back Mounting

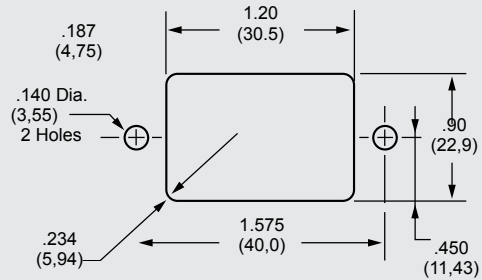

Front Mounting

## F2600FP, F3300FP

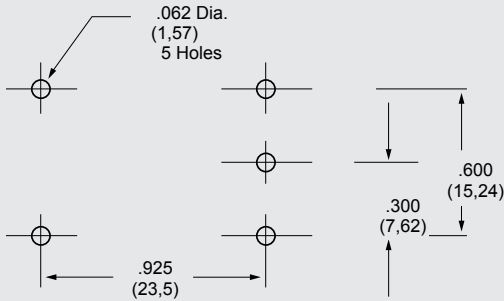

## F2600, F3300

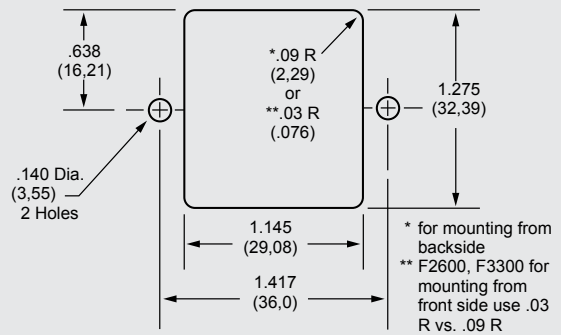

## F2700FB

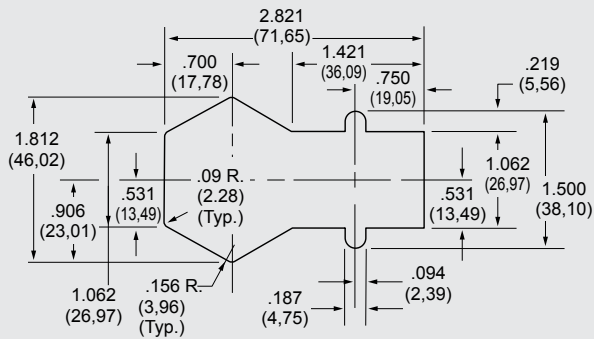

## PE1 Screw Mount Series

