

# MAXIM

## MAX9124 Evaluation Kit

### General Description

The MAX9124 evaluation kit (EV kit) contains a low-voltage differential signaling (LVDS) quad differential line driver (MAX9124) and receiver (MAX9125). The differential line driver accepts LVTTTL or LVCMOS inputs and translates them to LVDS output signals. The receiver accepts LVDS inputs and translates them to single-ended LVCMOS outputs. Both circuits operate with high data rates and low power dissipation.

The MAX9124 EV kit is designed with 50Ω controlled-impedance traces in a four-layer PC board. It is specially designed for direct differential probing of the LVDS I/O. Connection points are provided for the attachment of a cable to carry the LVDS signals.

The EV kit operates from a single 3.3V supply. In addition, a 1.2V power-supply input is provided for testing the driver's high-impedance propagation delays. A separate supply option for the driver and receiver allows testing of the common-mode performance of the receiver.

The MAX9124 EV kit can also be used to evaluate the MAX9126, which is the same as the MAX9125 but with integrated 115Ω (nominal) termination resistors. Additional pads on the board are provided for dynamically driving the enable and disable control signals with a pulse generator.

### Features

- ◆ Independent Quad Driver (MAX9124) and Quad Receiver (MAX9125/MAX9126) Circuits
- ◆ >500Mbps (250MHz) Switching Rate (MAX9125/MAX9126)
- ◆ >800Mbps (400MHz) Switching Rate (MAX9124)
- ◆ Supports Testing of Twisted-Pair Cables
- ◆ 50Ω Controlled-Impedance Signal Traces
- ◆ 16-Pin TSSOP Package
- ◆ Fully Assembled and Tested

### Ordering Information

PART	TEMP RANGE	IC PACKAGE
MAX9124EVKIT	0°C to +70°C	16 TSSOP

**Note:** To evaluate the MAX9126, request a MAX9126EUE free sample with the MAX9124EVKIT.

### Component List

DESIGNATION	QTY	DESCRIPTION
C1, C4, C9	3	10μF ±10%, 10V tantalum capacitors (case B) AVX TAJB106K010R or Kemet T494B106K010AS
C2, C11	2	1000pF ±10%, 50V X7R ceramic chip capacitors (0402) Murata GRM36X7R102K050A
C3, C5–C8, C10	6	0.1μF ±10%, 16V X7R ceramic chip capacitors (0603) Murata GRM39X7R104K016A
C12–C23	12	5.1pF ±0.1pF, 50V ceramic chip capacitors (0402) Murata GRM36COG5R1B050A
R1, R2, R3, R5–R10, R12–R16, R18–R21, R23, R24	20	49.9Ω ±1% resistors (0402)
R4, R11, R17, R22	0	Not installed, open resistor pads (0402)
R25–R28	4	100Ω ±1% resistors (0402)
R29–R32	4	2.0kΩ ±1% resistors (0603)
R33–R40	8	0Ω resistors (0603)

DESIGNATION	QTY	DESCRIPTION
R41–R48	0	Not installed, open resistor pads (0603)
R49, R50	0	Not installed, shorted resistor pads (0603)
JU1–JU6, JU15–JU20	12	3-pin headers
JU7–JU14	8	4-pin headers
JU21–JU28	8	2-pin headers
DEN, $\overline{DEN}$ , REN, REN	0	Not installed, SMA edge-mount connectors
DIN1–DIN4, RIN1- to RIN4-, RIN1+ to RIN4+	12	SMA edge-mount connectors
U1	1	MAX9124EUE (16-pin TSSOP)
U2	1	MAX9125EUE (16-pin TSSOP)
None	8	Shunts
None	1	MAX9124 PC board
None	1	MAX9124 EV kit data sheet
None	1	MAX9124/MAX9125 data sheet

# MAX9124 Evaluation Kit

## Component Suppliers

SUPPLIER	PHONE	FAX
AVX	803-943-0690	803-626-3123
Kemet	408-986-0424	408-986-1442
Murata	814-237-1431	814-238-0490

**Note:** Please indicate that you are using the MAX9124/MAX9125/MAX9126 when contacting these component suppliers.

## Quick Start

The MAX9124 EV kit is a fully assembled and tested surface-mount board. The EV kit contains an LVDS differential line driver located on the upper-half circuit, and receiver located on the lower-half circuit.

Recommended equipment includes:

- DC power supplies: one 3.3V  $\pm$ 0.3V, 400mA (or two 3.3V  $\pm$ 0.3V, 200mA supplies for powering the driver and receiver independently with R49 and R50 shorts cut open)
- Signal generator for LVDS signal input (e.g., HP 8131A)
- Differential probe (e.g., Tektronix P6248)
- Digital sampling oscilloscope or logic analyzer (e.g., Tektronix 11801C)

### Evaluating the Driver (MAX9124) Circuit

Follow the steps below to verify driver circuit operation. **Do not turn on the power supply until all connections are completed:**

- 1) Verify that a shunt is across pins 1 and 2 of JU2 (EN).
- 2) Connect a differential probe across pins 2 and 3 of JU7.
- 3) Connect a function generator that provides a square wave to the input of the driver circuit SMA connector DIN1 with the following settings:
  - a) Frequency = 10MHz
  - b)  $V_{IL} = 0.00V$ ,  $V_{IH} = 3.00V$
  - c) Duty cycle = 50%
- 4) Connect a 3.3V, 400mA power supply to the VCC1 pad. Connect the supply ground to the GND pad closest to VCC1.
- 5) Turn on the power supply, enable the function generator, and verify the differential output signal  $V_{OD} = (OUT1+ - OUT1-)$ .

**Note:** For connections to verify every channel, see Table 2.

### Evaluating the Receiver (MAX9125) Circuit

Follow the steps below to verify receiver circuit operation. **Do not turn on the power supply until all connections are completed:**

- 1) Verify that a shunt is across jumper JU16 (EN) pins 1 and 2.
- 2) Connect a scope probe across JU25 (OUT1) to observe the output signal.
- 3) Connect a function generator that provides square waves to the input of the receiver circuit (connect the noninverting signal to SMA connector RIN1+ and the inverting signal to SMA connector RIN1-) with the following settings:
  - a) Frequency = 10MHz
  - b)  $V_{IL} = 1.10V$ ,  $V_{IH} = 1.30V$
  - c) Duty cycle = 50%
- 4) Connect a 3.3V, 400mA power supply to the VCC2 pad. Connect the supply ground to the GND pad closest to VCC2.
- 5) Turn on the power supply and enable the function generator, then verify the output signal (OUT1) on the scope.

**Note:** For connections to verify every channel, see Table 3.

## Detailed Description

The MAX9124 EV kit is a fully assembled and tested circuit board that includes a quad LVDS differential line driver and receiver. The EV kit has two independent circuits. The upper-half circuit is a driver circuit and the lower-half circuit is a receiver circuit. The two circuits can be operated together or separately. Both circuits' I/Os are specially designed for direct probing.

The EV kit is a four-layer PC board with 50 $\Omega$  controlled-impedance traces for all input signal traces with 49.9 $\Omega$  termination resistors. The two circuits can be linked by connecting an output signal from the driver circuit to the input of the receiver circuit. Each differential input pair traces are laid out with less than 100mil length difference.

### Using Separate Power Supplies

The MAX9124 EV kit contains two separate circuits that can be operated with independent supplies after cutting open the shorts at R49 and R50. Independent power and ground planes allow measurements of the receivers' response to ground shift or other common-mode effects. Each circuit requires a 3.3V, 200mA power supply. In addition, if high-impedance delay testing is to be performed, a 1.2V voltage supply is required.

# MAX9124 Evaluation Kit

Evaluates: MAX9124/MAX9125/MAX9126

## Input Signal

The MAX9124 EV kit provides internal DC or external AC input signals to the driver circuit and two kinds of input media, SMA coax or twisted-pair cable, to the receiver circuit.

## Driver Circuit Input

The MAX9124 EV kit accepts both internal (DC) and external (AC) inputs to the driver circuit. **Before driving AC external input signals to DIN1–DIN4 to the driver circuit, verify there are no shunts across JU1, JU3, JU4, and JU6 (Table 1).** JU1, JU3, JU4, and JU6 can create DC internal input signals to the driver. **To use JU1, JU3, JU4, and JU6 to create DC input signals, make sure termination resistors R1, R7, R8, and R14 are removed.**

## Receiver Circuit Input

The MAX9124 EV kit also provides two interconnect options to the receiver circuit: coaxial cable and twist-

**Table 1. Using JU1, JU3, JU4, and JU6 to Provide Input Signals to the Driver Circuit**

JUMPER	SHUNT LOCATION	IN PIN	DRIVER INPUT SIGNAL
JU1	1 and 2	Connected to V <sub>CC</sub>	IN1 = high
	2 and 3	Connected to GND	IN1 = low
JU3	1 and 2	Connected to V <sub>CC</sub>	IN2 = high
	2 and 3	Connected to GND	IN2 = low
JU6	1 and 2	Connected to V <sub>CC</sub>	IN3 = high
	2 and 3	Connected to GND	IN3 = low
JU4	1 and 2	Connected to V <sub>CC</sub>	IN4 = high
	2 and 3	Connected to GND	IN4 = low

**Table 2. Driver Probing Connections**

CHANNEL NAME	IC OUTPUT PIN NAME	TESTING POINT	PROBING HEADER (4 PIN), PIN NO.	PROBING (OUT+ - OUT-)
Channel 1	OUT1+	DOUT1+	JU7, pins 2 (+) and 1 (-)	JU7, pins 2 (+) and 3 (-)
	OUT1-	DOUT1-	JU7, pins 3 (+) and 4 (-)	
Channel 2	OUT2+	DOUT2+	JU8, pins 2 (+) and 1 (-)	JU8, pins 3 (+) and 2 (-)
	OUT2-	DOUT2-	JU8, pins 3 (+) and 4 (-)	
Channel 3	OUT3+	DOUT3+	JU10, pins 2 (+) and 1 (-)	JU10, pins 3 (+) and 2 (-)
	OUT3-	DOUT3-	JU10, pins 3 (+) and 4 (-)	
Channel 4	OUT4+	DOUT4+	JU9, pins 2 (+) and 1 (-)	JU9, pins 2 (+) and 3 (-)
	OUT4-	DOUT4-	JU9, pins 3 (+) and 4 (-)	

ed-pair cable. When 49.9Ω termination resistors R15, R16, R18–R21, and R23, R24 are installed, the fail-safe feature is disabled. To test the fail-safe feature, remove termination resistors R15, R16, R18–R21, and R23, R24. Additional paired testing points (IN1+, IN1-) (IN2+, IN2-) (IN3+, IN3-) (IN4+, IN4-) are provided for the twisted-pair cable connections. When twisted-pair cables are used as the input media (twisted-pair cables are soldered on testing points IN1-, IN1+, etc.), remove all 0Ω resistors R33–R40 to avoid signal reflection from the traces that connect 0Ω resistors to SMA connectors.

## Output Signal

The MAX9124 EV kit is designed for direct probing of all output signals. Additional paired testing points (DOUT1-, DOUT1+), (DOUT2+, DOUT2-), (DOUT3+, DOUT3-), (DOUT4+, DOUT4-) are also provided for connection of twisted-pair cables and probing of the driver outputs.

## Probing Connections

The MAX9124 EV kit is designed for direct differential probing connections. Tables 2 and 3 list the direct probing connections on the respective pins for all input and output signals and their respective testing points.

## Enable/Disable

The MAX9124 EV kit has two enables and two disables. All enables and disables can be controlled by either jumpers or external signals. Jumpers JU2, JU5, JU16, and JU19 provide a DC logic signal to driver's EN and  $\overline{\text{EN}}$  and receiver's EN and  $\overline{\text{EN}}$ , respectively (Table 4). Table 5 is the enable/disable truth table.

The EV kit can also be controlled by external enable/disable signal(s). To use external signals to control enable and disable, SMA connectors need to

# MAX9124 Evaluation Kit

**Table 3. Receiver Probing Connections**

CHANNEL NAME	IC OUTPUT PIN NAME	TESTING POINT	PROBING HEADER (4 PIN), PIN NO.	OUTPUT SIGNAL	PROBING HEADER (2 PIN)
Channel 1	IN1-	IN1-	JU11, pins 2 (+) and 1 (-)	OUT1	JU25
	IN1+	IN1+	JU11, pins 3 (+) and 4 (-)		
Channel 2	IN2+	IN2+	JU12, pins 2 (+) and 1 (-)	OUT2	JU26
	IN2-	IN2-	JU12, pins 3 (+) and 4 (-)		
Channel 3	IN3-	IN3-	JU14, pins 3 (+) and 4 (-)	OUT3	JU28
	IN3+	IN3+	JU14, pins 2 (+) and 1 (-)		
Channel 4	IN4+	IN4+	JU13, pins 3 (+) and 4 (-)	OUT4	JU27
	IN4-	IN4-	JU13, pins 2 (+) and 1 (-)		

be added on DEN, REN,  $\overline{\text{DEN}}$ , and  $\overline{\text{REN}}$  pads with 49.9 $\Omega$  termination resistors R4, R17, R11, and R22. **Before connecting external signals to DEN, REN,  $\overline{\text{DEN}}$ ,  $\overline{\text{REN}}$ , verify there are no shunts across jumpers JU4, JU17, JU11, and JU22.**

### Evaluating Driver and Receiver Together

**Table 4. JU2, JU5, JU16, and JU19 Setting and Enable/Disable Logic Level**

JUMPER	SHUNT LOCATION	ENABLE/DISABLE LOGIC LEVEL
JU2, JU5,	1 and 2, connected to VCC	High
JU16,	2 and 3, connected to GND	Low
JU19	Open, no shunt	Float

**Table 5. Enable and Disable Truth Table**

DEN (REN)	$\overline{\text{DEN}}$ ( $\overline{\text{REN}}$ )	OPERATION FUNCTION
Low	High	U1 (U2) disable
All other combinations (including floating)		U1 (U2) enable

To evaluate the LVDS differential line driver (MAX9124) and receiver (MAX9125) together, remove 0 $\Omega$  resistors R33–R40 at the input of the receiver circuit, and remove capacitors C12–C19 and 49.9 $\Omega$  termination resistors R2, R3, R5, R6, R9, R10, R12, and R13 at the output of the driver. Use 100 $\Omega$  twisted-pair cable (such as CAT-5) to connect the driver outputs to the receiver inputs. Connect one end of the twisted-pair cable to test point DOUT1- and another end to IN1-, etc. Connect function

generator(s) to the driver input(s), and probe at receiver or driver I/Os.

Follow these steps to verify board operation. **Do not turn on the power supply until all connections are completed:**

- 1) Verify shunts across jumper JU2 (DEN) and JU16 (REN) pins 1 and 2.
- 2) Connect a function generator to the driver input DIN1 with the following settings:
  - a) Frequency = 10MHz
  - b)  $V_{IL} = 0.00V$ ,  $V_{IH} = 3.00V$
  - c) Duty cycle = 50%
- 3) Connect a scope probe across jumper JU25 (OUT1). Use 100 $\Omega$  twisted-pair cable to connect the driver outputs to the receiver inputs as shown in Figure 1.
- 4) Single power supply (for the normal operation): Connect a 3.3V, 400mA power supply to VCC1. Connect the supply ground to the GND pad closest to VCC1.

**Optional separate power supplies (for testing receiver common-mode response): Connect 3.3V, 200mA power supplies to VCC1 and VCC2. Connect the supply grounds to the GND pads closest VCC1 and VCC2, respectively. Be sure R49 and R50 shorts are cut open.**

- 5) Turn on the power supply (supplies), enable the function generator, and verify the output.

**Note:** For connections to verify every channel, see Tables 2 and 3.

### Evaluating MAX9126

The MAX9124 EV kit can also evaluate the MAX9126, a differential line receiver with 115 $\Omega$  internal termination

# MAX9124 Evaluation Kit

Evaluates: MAX9124/MAX9125/MAX9126

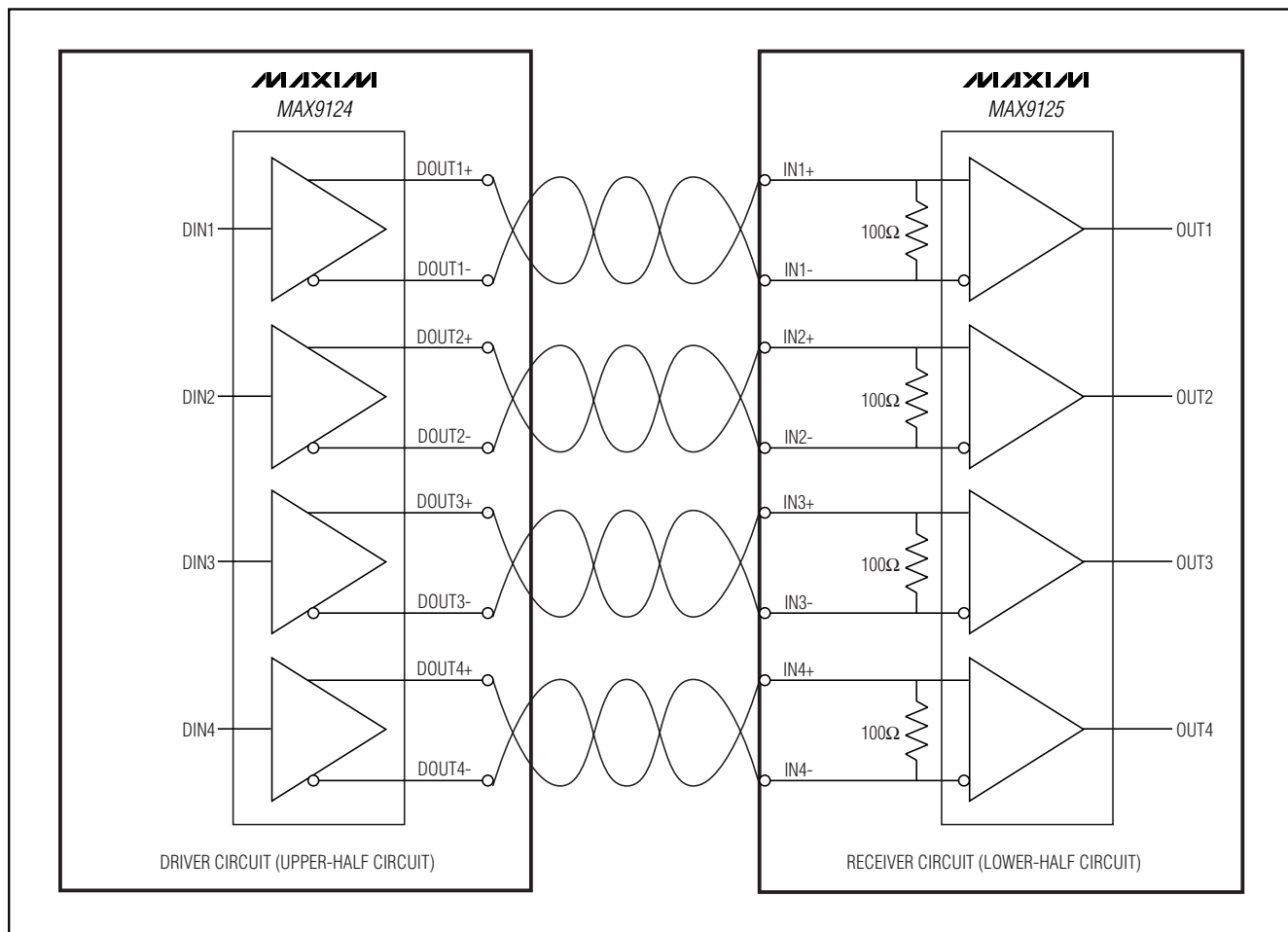

Figure 1. Twisted-Pair Cable Interconnect Diagram

resistors. To evaluate the MAX9126, replace MAX9125EUE with a MAX9126EUE and remove the external 100Ω resistors R25 to R28.



# MAX9124 Evaluation Kit

MAX9124/MAX9125/MAX9126

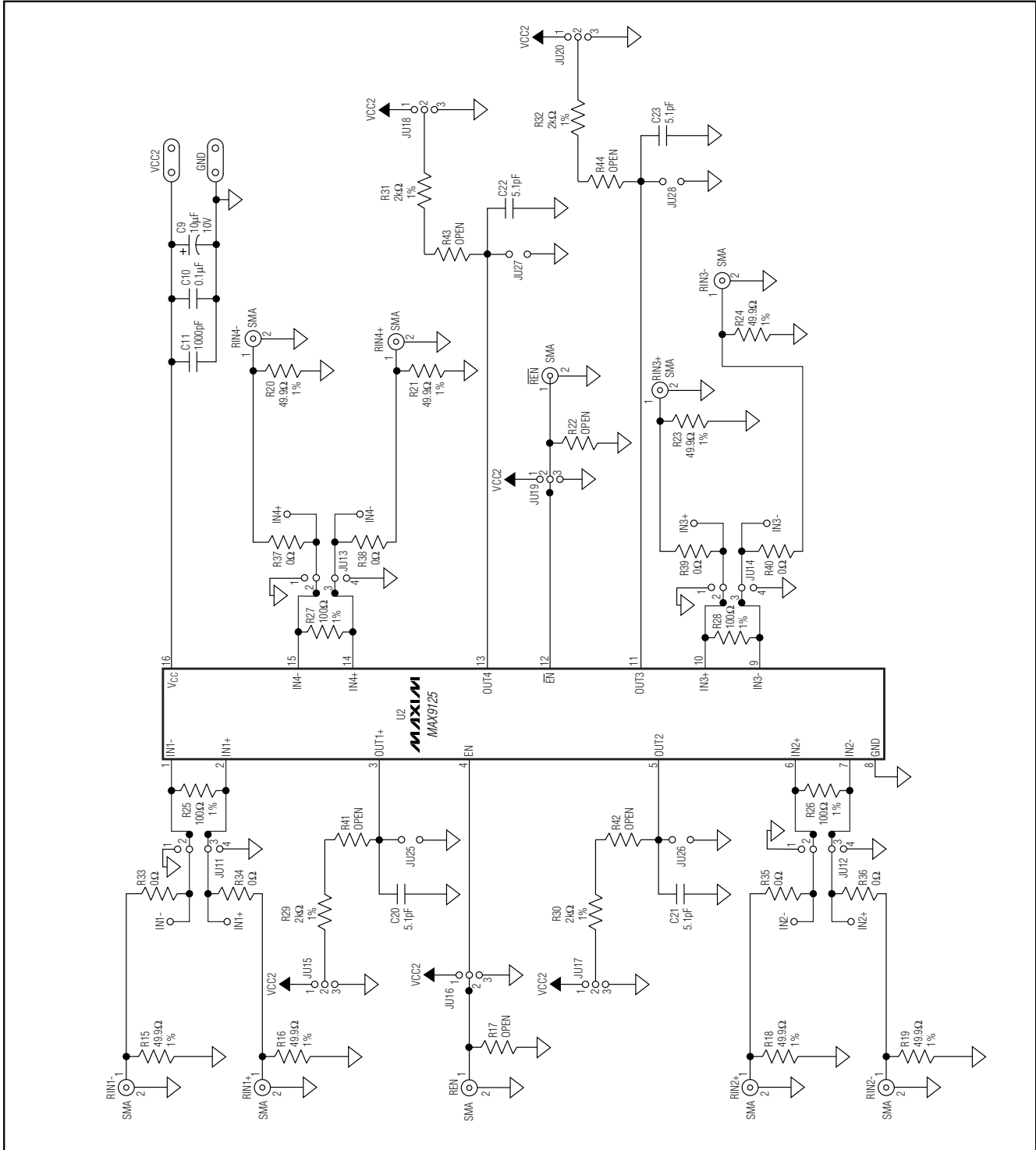

Figure 3. MAX9124 EV Kit Schematic (Receiver Circuit)

# MAX9124 Evaluation Kit

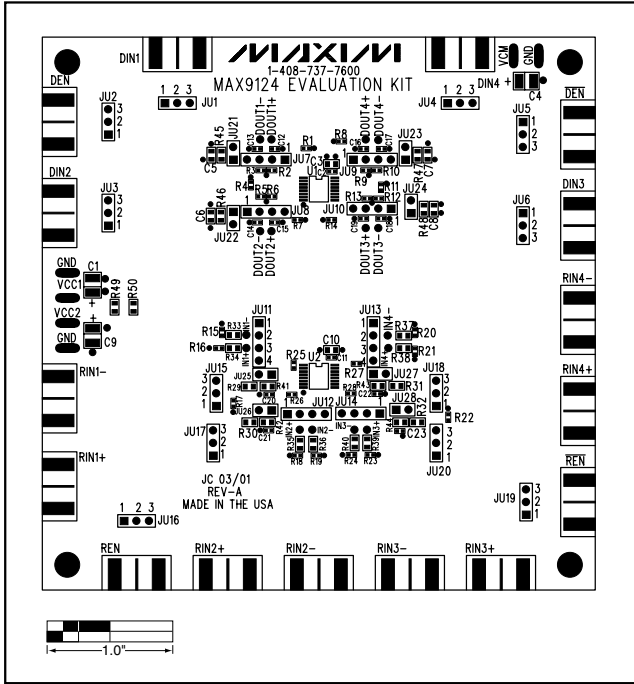

Figure 4. MAX9124 EV Kit PC Component Placement Guide—Component Side

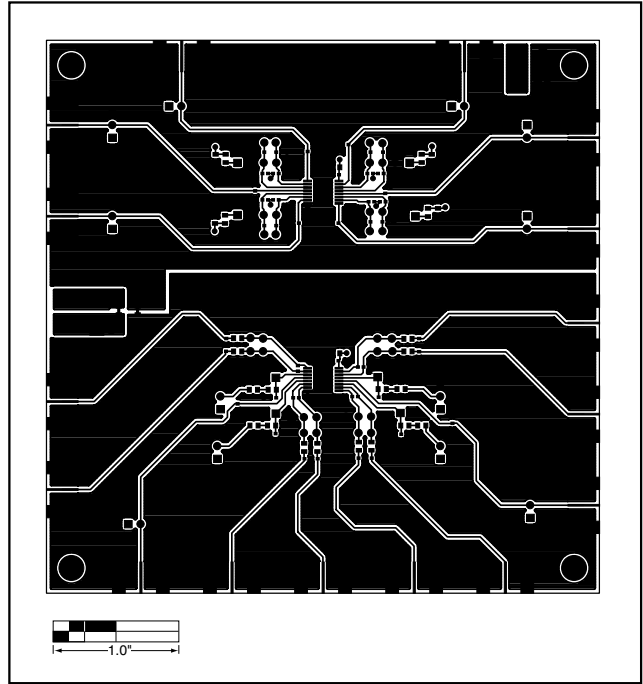

Figure 5. MAX9124 EV Kit PC Board Layout—Component Side

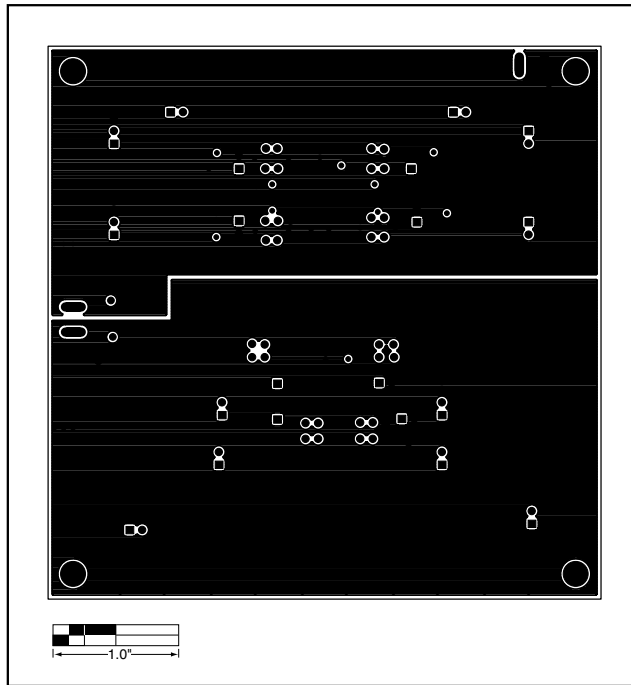

Figure 6. MAX9124 EV Kit PC Board Layout—Inner Layer 2



# MAX9124 Evaluation Kit

MAX9124/MAX9125/MAX9126

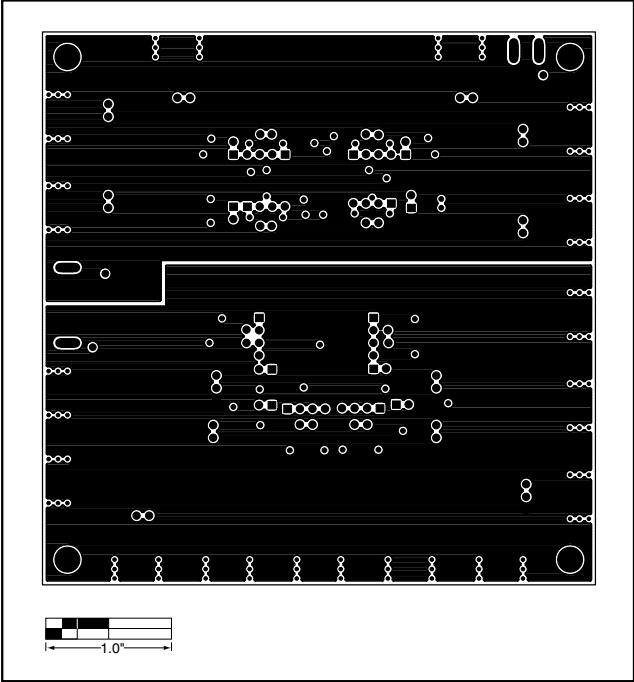

Figure 7. MAX9124 EV Kit PC Board Layout—Inner Layer 3

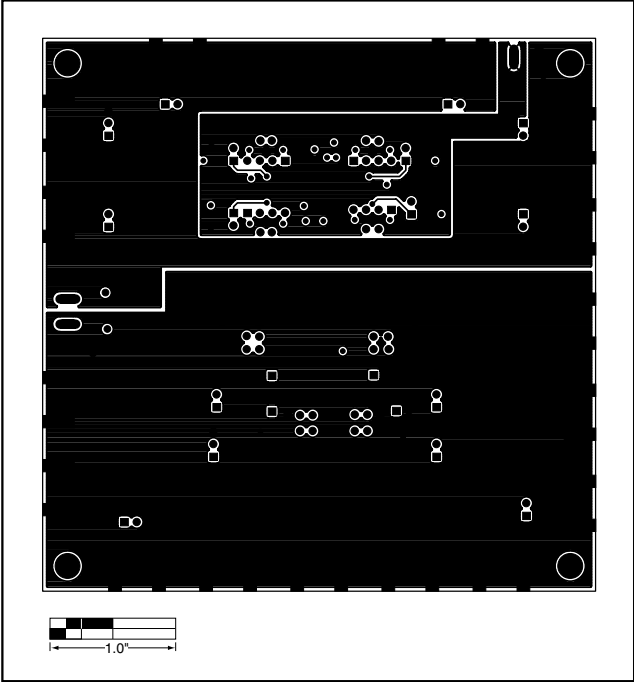

Figure 8. MAX9124 EV Kit PC Board Layout—Solder Side

Maxim cannot assume responsibility for use of any circuitry other than circuitry entirely embodied in a Maxim product. No circuit patent licenses are implied. Maxim reserves the right to change the circuitry and specifications without notice at any time.

9 \_\_\_\_\_ **Maxim Integrated Products, 120 San Gabriel Drive, Sunnyvale, CA 94086 408-737-7600**