

4

3

2

1

THIS DRAWING IS UNPUBLISHED. RELEASED FOR PUBLICATION 2010  
 © COPYRIGHT 2010 BY TYCO ELECTRONICS CORPORATION. ALL RIGHTS RESERVED.

LOC	DIST	REVISIONS			
P	LTR	DESCRIPTION	DATE	DWN	APVD
E	B	BA	NEW RELEASE	06JULY2010	PT St.P

FOR FURTHER INFORMATION SEE DATA SHEET FOR SERIES LR, METAL FILM FIXED RESISTORS

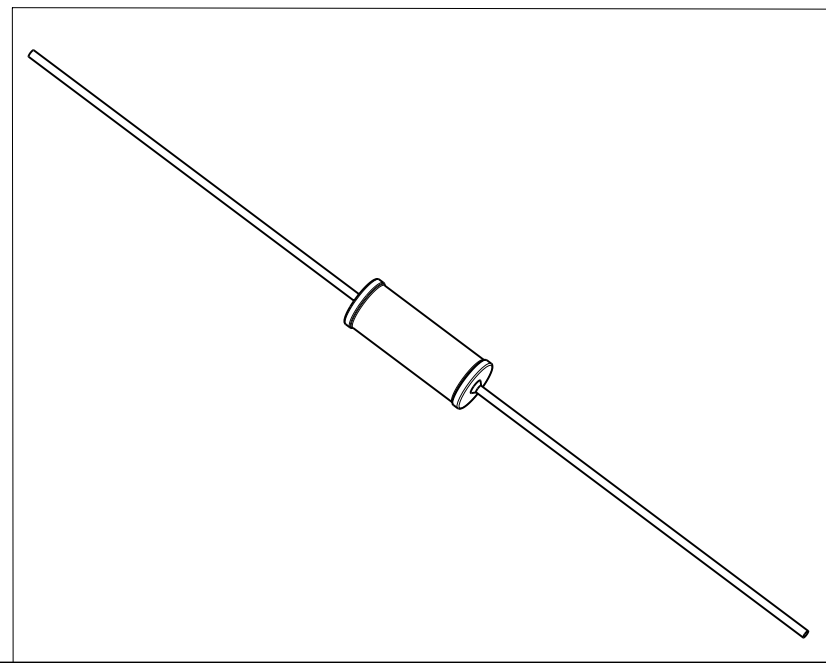
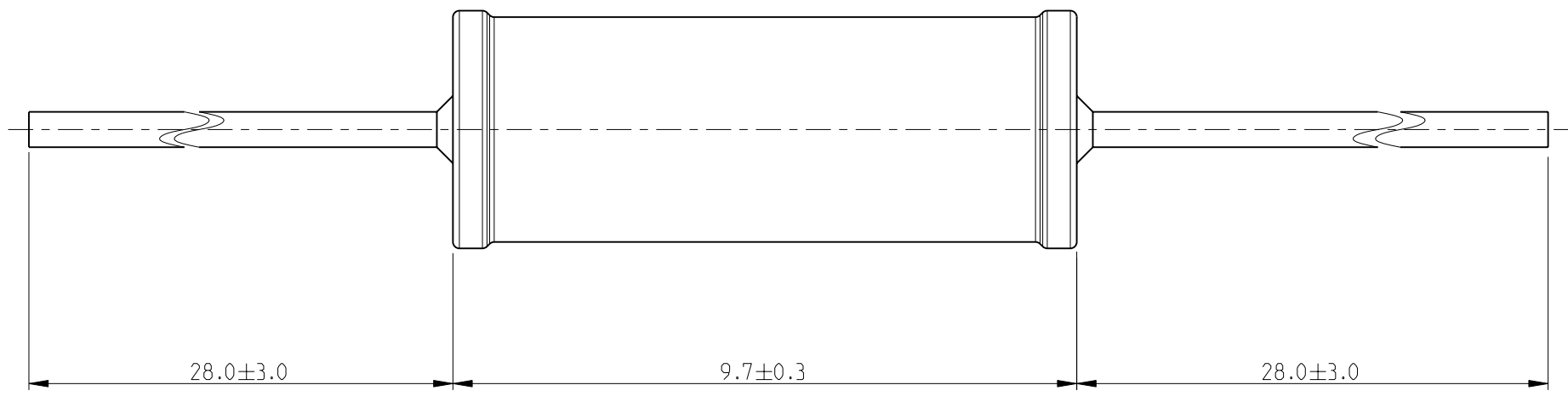
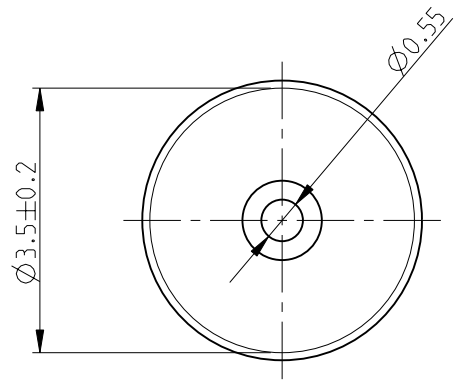

RoHS Compliant

<small>THIS DRAWING IS A CONTROLLED DOCUMENT FOR TYCO ELECTRONICS CORPORATION IT IS SUBJECT TO CHANGE AND THE CONTROLLING ENGINEERING ORGANIZATION SHOULD BE CONTACTED FOR THE LATEST REVISION.</small>	
DIMENSIONS:	TOLERANCES UNLESS OTHERWISE SPECIFIED:
mm	
	0 PLC ± 0.2
	1 PLC ± 0.1
	2 PLC ± -
	3 PLC ± -
	4 PLC ± -
	ANGLES ± 5°
MATERIAL -	FINISH -

DWN	06JULY2010
PARUSURAM.T	
CHK	06JULY2010
ALLAN.P	
APVD	06JULY2010
STEPHEN.P	
PRODUCT SPEC	-
APPLICATION SPEC	-
WEIGHT	-

Tyco Electronics Corporation Dorcan, Swindon, SN3 5HH	
NAME METAL FILM FIXED RESISTORS SERIES LR2	
SIZE A3	CAGE CODE 00779
DRAWING NO C-1622774	RESTRICTED TO -
CUSTOMER DRAWING	SCALE 10:1 SHEET 1 OF 1 REV BA