

Spec No.	DG-133040
Issue	03-Apr-13

## S P E C I F I C A T I O N S

Product Type ZENIGATA LED

Model No. GW6TGCBG30C

※These specifications contain 15 pages including the cover and appendix.  
If you have any objections, please contact us before issuing purchasing order.

CUSTOMERS ACCEPTANCE

DATE: \_\_\_\_\_

BY: \_\_\_\_\_

### Reference

PRESENTED

BY: \_\_\_\_\_

T. Uemura  
Dept. General Manager

REVIEWED BY: \_\_\_\_\_ PREPARED BY: \_\_\_\_\_

Development Department II  
Lighting Device Division  
Electronic Components And Devices Group  
SHARP CORPORATION

- Handle this document carefully for it contains material protected by international copyright law. Any reproduction, full or in part, of this material is prohibited without the express written permission of the company.
  
- When using the products covered herein, please observe the conditions written herein and the precautions outlined in the following paragraphs. In no event shall the company be liable for any damages resulting from failure to strictly adhere to these conditions and precautions.
  - (1) Please do verify the validity of this part after assembling it in customer's products, when customer wants to make catalogue and instruction manual based on the specification sheet of this part.
  
  - (2) The products covered herein are designed and manufactured for the following application areas. When using the products covered herein for the equipment listed in paragraph (3), even for the following application areas, be sure to observe the precautions given in Paragraph (3). Never use the products for the equipment listed in Paragraph (4).
    - Office electronics
    - Instrumentation and measuring equipment
    - Machine tools
    - Audiovisual equipment
    - Home appliances
    - Communication equipment other than for trunk lines
  
  - (3) These contemplating using the products covered herein for the following equipment which demands high reliability, should first contact a sales representative of the company and then accept responsibility for incorporating into the design fail-safe operation, redundancy, and other appropriate measures for ensuring reliability and safety of the equipment and the overall system.
    - Control and safety devices for airplanes, trains, automobiles, and other transportation equipment
    - Mainframe computers
    - traffic control systems
    - Gas leak detectors and automatic cutoff devices
    - Rescue and security equipment
    - Other safety devices and safety equipment, etc.
  
  - (4) Do not use the products covered herein for the following equipment which demands extremely high performance in terms of functionality, reliability, or accuracy.
    - Aerospace equipment
    - Communications equipment for trunk lines
    - Control equipment for the nuclear power industry
    - Medical equipment related to life support, etc.
  
  - (5) please direct all queries and comments regarding the interpretation of the above four Paragraphs to a sales representative of the company.
  
- Please direct all queries regarding the products covered herein to a sales representative of the company.

## GW6TGCBG30C specifications

### 1. Application

These specifications apply to the light emitting diode module Model No. GW6TGCBG30C.

[ LED module (InGaN Blue LED chip + Phosphor) ]

Main application : Lighting

### 2. External dimensions and equivalent circuit ----- Refer to Page 2.

### 3. Ratings and characteristics ----- Refer to Page 3 - 4.

3-1. Absolute maximum ratings

3-2. Electro-optical characteristics

3-3. Derating curve

### 4. Reliability ----- Refer to Page 5.

4-1. Test items and test conditions

4-2. Failure criteria

### 5. Quality level ----- Refer to Page 6.

5-1. Applied standard

5-2. Sampling inspection

5-3. Inspection items and defect criteria

### 6. Supplements----- Refer to Page 7 - 9.

6-1. Chromaticity rank table

6-2. Packing

6-3. Label

6-4. Indication printed on product

### 7. Precautions ----- Refer to Page 10 - 12.

### 8. Characteristics diagram (TYP.) ----- Refer to Page 13.

## 2. External dimensions and equivalent circuit

Unit = mm

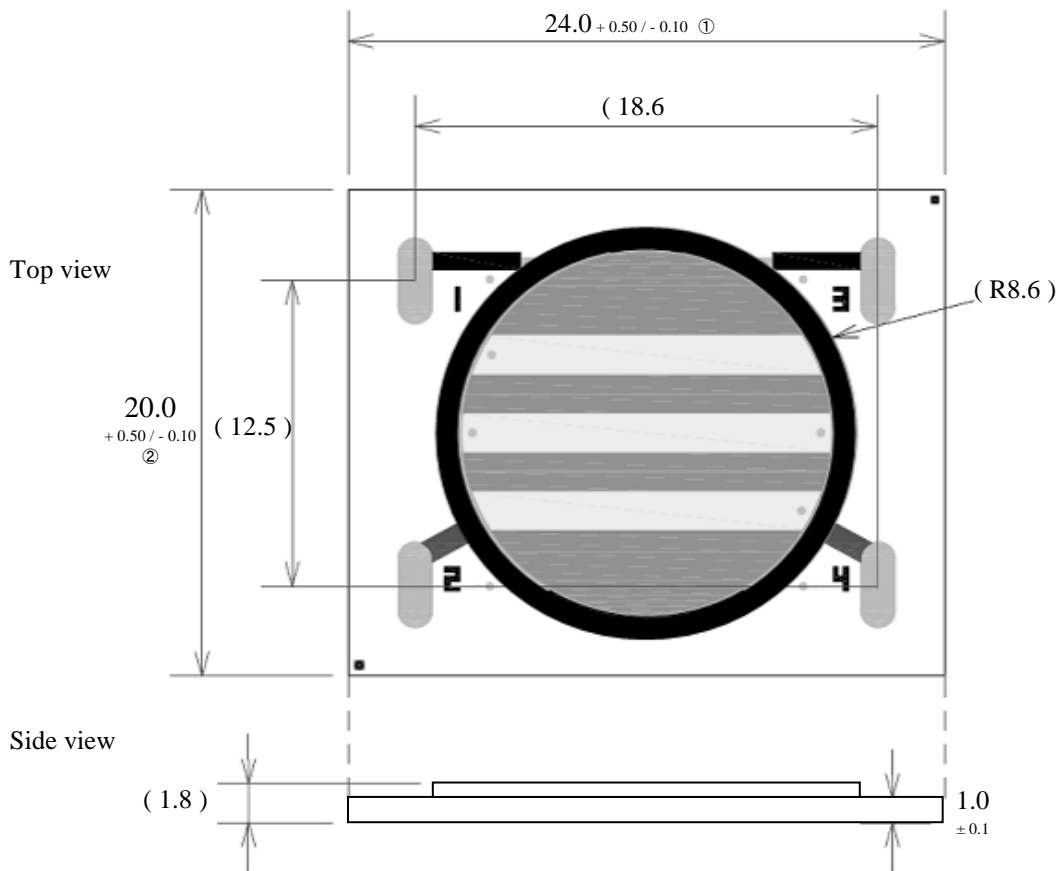

(Note) Values inside parentheses are reference values.  
 External sizes of ①, ② are determined by maximum dimensions,  
 that include salient areas on the edges of respective sides.

### Equivalent circuit

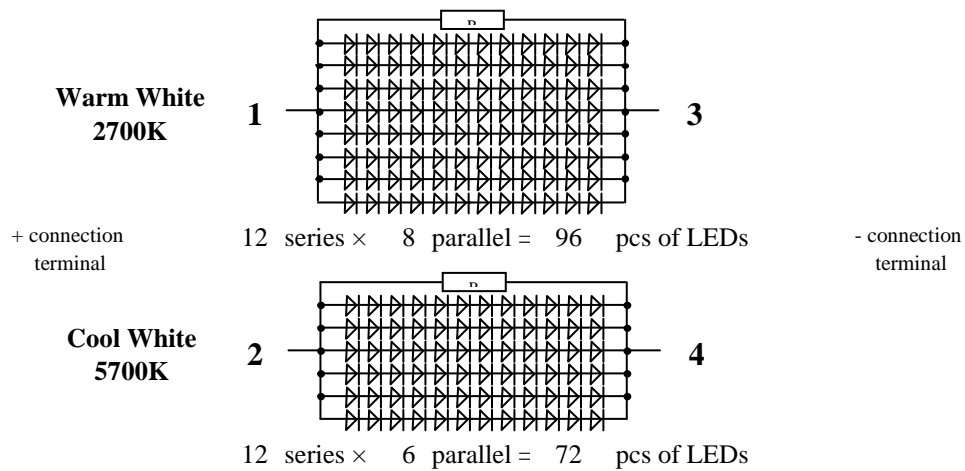

Unit	Material	Drawing No.
mm	Substrate : Alumina Ceramic	52503025

### 3. Ratings and characteristics

#### 3-1. Absolute maximum ratings

Item	Symbol	Rating	Unit
Power Dissipation *1,4,5	P	34.0	W
Forward Current *1,4,5	I <sub>F</sub>	840	mA
Reverse Voltage *2,4	V <sub>R</sub>	-15	V
Operating Temperature *3	T <sub>opr</sub>	- 30 ~ + 100	°C
Storage Temperature	T <sub>stg</sub>	- 40 ~ + 100	°C

\*1 Power dissipation and forward current are the value when the module temperature is set lower than the rating by using an adequate heat sink.

\*2 Voltage resistible at initial connection error  
(Not dealing with the possibility of always-on reverse voltage.)

\*3 Case temperature T<sub>c</sub> (Refer to measuring point for case temperature in the next page.)  
Refer to "Derating curve" in the next page as for operating current.

\*4 T<sub>c</sub> = 25 °C

\*5 Absolute maximum of Power Dissipation and Forward Current are for summation of 1-3(warm white) and 2-4(cool white), not for individual value of each input.

(T<sub>j</sub> = 25 °C)

#### 3-2. Electro-optical characteristics

CCT	Item	Symbol	Condition	MIN.	TYP.	MAX.	Unit
2700K	Forward Voltage *5	V <sub>F</sub>	I <sub>F</sub> = 700 mA If_1-3	34	37	40	V
	Luminous Flux *6	Φ		1650	(1840)	-	lm
	Chromaticity Coordinates *7	x		-	(0.458)	-	-
		y		-	(0.412)	-	-
General Color Rendering Index *8	R <sub>a</sub>	93	(96)	-	-		
5700K	Forward Voltage *5	V <sub>F</sub>	I <sub>F</sub> = 700 mA If_2-4	35	38	41	V
	Luminous Flux *6	Φ		1950	(2170)	-	lm
	Chromaticity Coordinates *7	x		-	(0.330)	-	-
		y		-	(0.340)	-	-
General Color Rendering Index *8	R <sub>a</sub>	87	(90)	-	-		

(Note) Values inside parentheses are shown for reference purpose only.

\*5 (After 20 ms drive, T<sub>j</sub> = 25 °C, Measurement tolerance: ± 3 %)

\*6 Monitored by Sharp's 8 inch integrating sphere and Otsuka electronics MCPD-LE3400  
(After 20 ms drive, T<sub>j</sub> = 25 °C, Measurement tolerance: ± 10 %)

\*7 Monitored by Sharp's 8 inch integrating sphere and Otsuka electronics MCPD-LE3400  
(After 20 ms drive, T<sub>j</sub> = 25 °C, Measurement tolerance: ± 0.005)

\*8 Monitored by Sharp's 8 inch integrating sphere and Otsuka electronics MCPD-LE3400  
(After 20 ms drive, T<sub>j</sub> = 25 °C, Measurement tolerance: ± 2)

### 3-3. Derating curve

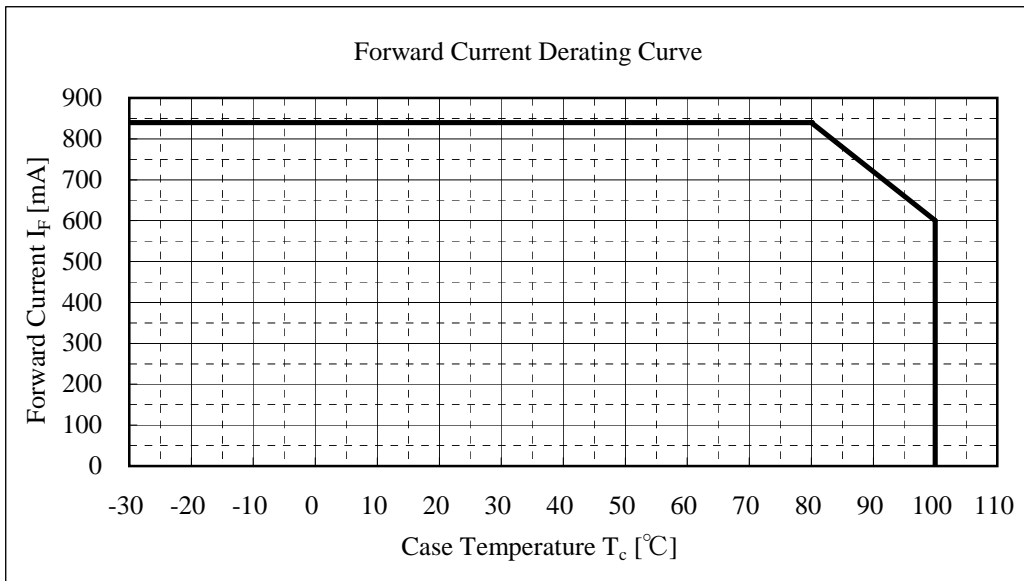

(Note) To keep the case temperature lower than the rating, enough heat-radiation performance needs to be secured by using an adequate heat sink.

Please ensure the maintenance of heat radiation not to exceed case temperature over the rating in operation.

(Measuring point for case temperature)

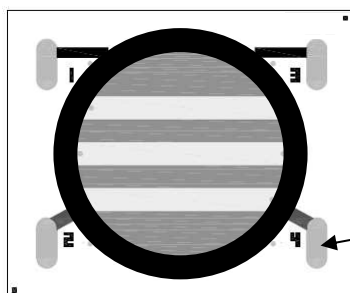

Please take note of the following, when measuring case temperature

1. The LED device mounting surface should be flat/plain surface
2. The substrate surface temperature should be uniform.

Thermal resistance: 1.24°C/W (2700K·If<sub>1-3</sub>, standard value)  
1.91°C/W (5700K·If<sub>2-4</sub>, standard value)

## 4. Reliability

The reliability of products shall be satisfied with items listed below.

### 4-1. Test items and test conditions

Confidence level: 90 %

No.	Test item	Test conditions	Samples n	Defective C	LTPD (%)
1	Temperature Cycle	- 40 °C(30 min) ~ + 100 °C(30 min), 100 cycles	11	0	20
2	Temperature Humidity Storage	T <sub>stg</sub> = + 60 °C, RH = 90 %, Time = 1000 h	11	0	20
3	High Temperature Storage	T <sub>stg</sub> = + 100°C, Time = 1000 h	11	0	20
4	Low Temperature Storage	T <sub>stg</sub> = - 40 °C, Time = 1000 h	11	0	20
5	Steady State Operating Life	T <sub>c</sub> = 90 °C, I <sub>F</sub> = 700 mA, Time = 1000 h	11	0	20
6	Shock	Acceleration: 15000 m/s <sup>2</sup> , Pulse width: 0.5 ms Direction: 3 directions (X, Y and Z) 3 trials in each direction	5	0	50
7	Vibration	Frequency: 100 to 2000 Hz for 4 minutes per trial Acceleration: 200 m/s <sup>2</sup> Direction: 3 directions (X, Y and Z) 4 trials in each direction	5	0	50

### 4-2. Failure criteria

No.	Parameter	Symbol	Failure criteria
1	Forward Voltage	V <sub>F</sub>	V <sub>F</sub> > Initial value × 1.1
2	Luminous Flux	Φ	Φ < Initial value × 0.7

## 5. Quality level

5-1. Applied standard  
ISO2859-1

5-2. Sampling inspection  
A single normal sampling plan, level S-4.

### 5-3. Inspection items and defect criteria

No.	Item	Defect criteria	Classification	AQL
1	No radiation	No light emitting	Major defect	0.1
2	Electro-optical characteristics	Not conforming to the specification (Forward voltage, Luminous flux and Chromaticity)	Minor defect	0.4
3	External dimensions	Not conforming to the specified dimensions (External dimensions of ① and ② shown in Page 2)		
4	Appearance	Nonconformity observed in product appearance is determined as defective only when electro-optical characteristics is affected by. <If any question arises regardless of above mentioned criterion> <ul style="list-style-type: none"> <li>■ Foreign material, scratch, or bubble at emitting area: 0.8 mm φ</li> <li>■ Fiber generation at emitting area: 0.2 mm in width and 2.5 mm in length</li> <li>■ Foreign material at connection terminal: 0.8 mm φ</li> <li>■ Substrate burr on edge: Over dimension tolerance</li> </ul>		

(Note) Products with removable foreign material attached on is not determined to be defective.

(Note) Substrate cracks that do not effect the electrical/optical charecteristics are not determined to be defective.



## 6. Supplements

### 6-1. Chromaticity rank table

(Tolerance:  $x, y \pm 0.005$ )  
 ( $I_F = 700 \text{ mA}, T_j = 25 \text{ }^\circ\text{C}$ )

ランク			Chromaticity Diagram			
			Point 1	Point 2	Point 3	Point 4
1	2700K	x	0.4552	0.4480	0.4608	0.4680
		y	0.4220	0.4020	0.4020	0.4220
	5700K	x	0.3269	0.3200	0.3331	0.3400
		y	0.3500	0.3300	0.3300	0.3500

..... : Black Body curve

Chromaticity Diagram

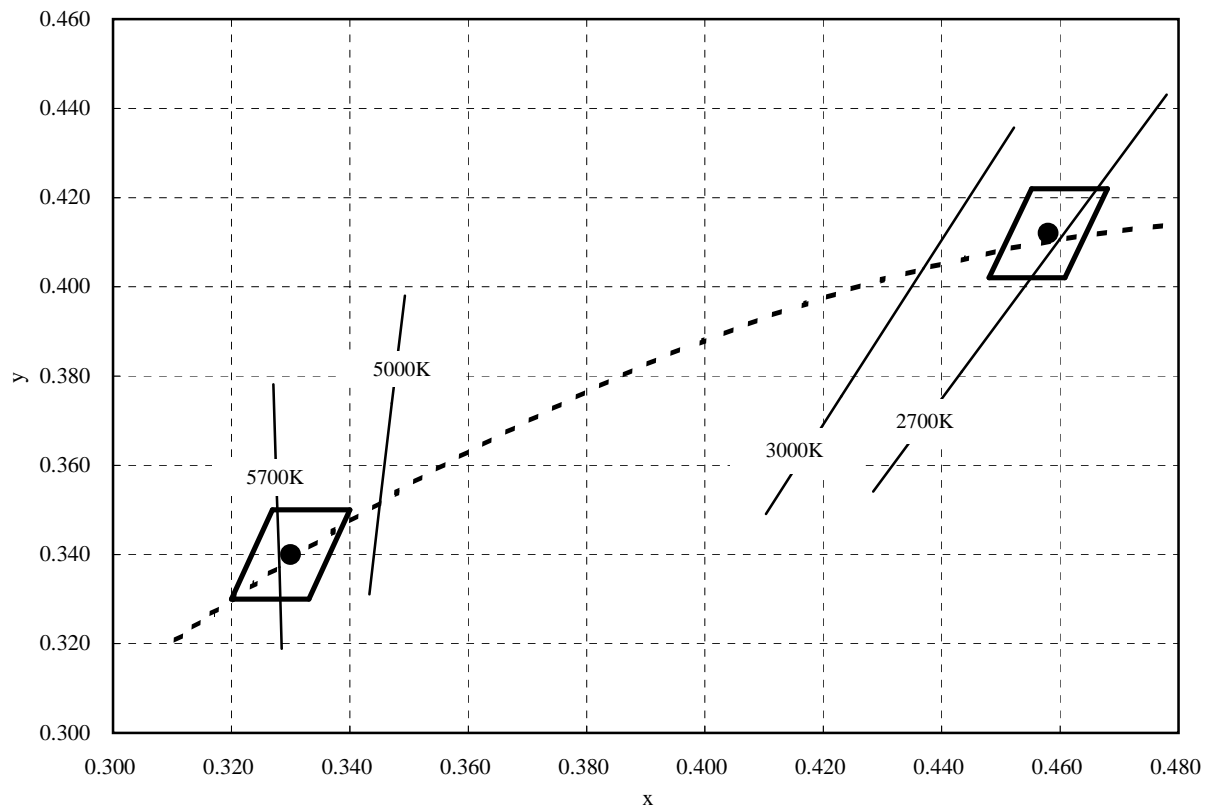

## 6-2. Packing

- One tray composed of 40 pieces
- 5 trays (200 pieces) and one upper lid-tray in one moisture-proof bag
- 2 bags (400 pieces) in one carton
- Dimensions of outer carton: 235 × 220 × 90 mm (Reference value)

(Note 1) There are cases of one carton composed of one bag. (200 pieces)

(Note 2) State of packing is subject to change.

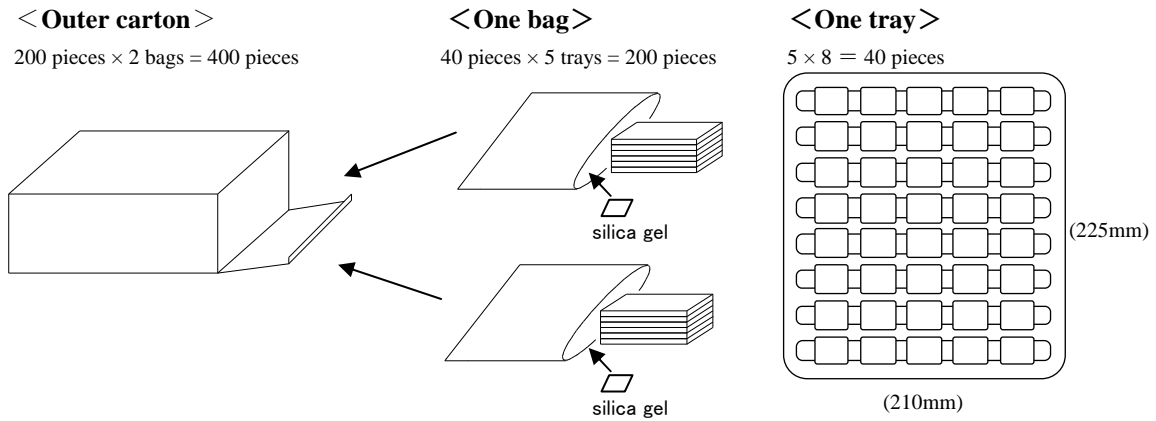

6-3. Label

1) Outer carton

Following label is attached on outer carton.

(Note 3) Label format is subjected to change.

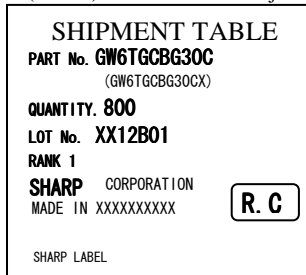

- ← Model number
- ← (Model number + suffix code)
- ← Quantity
- ← Lot No.
- ← Rank
- ← Production country
  - MADE IN PHILIPPINES
  - MADE IN INDONESIA

1) Lot No. indication

X X 1 2 B 0 1  
① ② ③ ④

- ① Production plant code(PHL(MAT):MI,IDN(SSI):SA)
- ② Shipping year (Year last 2 digits)
- ③ Shipping month  
(from January to December in ABC order)
- ④ Shipping date (01~31)

2)Moisture-Proof bag

Following label is attached on moisture-proof bags.

(Note 3) Label format is subjected to change.



- ← Model number
- ← (Model number + suffix code)
- ← Quantity and rank
- ← Lot No.
- ← Bar code
- ← Production country

1) Lot No. indication

X X 2 3 G 0 1 0 0 1 A  
① ② ③ ④ ⑤ ⑥ ⑦

- ① Production plant code(PHL(MAT):50,IDN(SSI):00)
- ② Shipping year (Year last digit)
- ③ Shipping month (1~9 or O, N, D)
- ④ Fixed code G
- ⑤ Shipping date (01~31)
- ⑥ Serial No.
- ⑦ Backup code A

6-4. Indication printed on product

Model No. and control No. are indicated on substrate surface.

1) Model No.

Abbreviated Model No. " 6TGCBG30C " is indicated.

2) Control No.

Indicated as follows;

X 1 2 B 0 1  
① ② ③ ④

- ① Production plant code (to be indicated alphabetically)  
PHL(MAT):M、 IDN(SSI):Y
- ② Year of production (the last two figures of the year)
- ③ Month of production  
(to be indicated alphabetically with January corresponding to A)
- ④ Date of production (01~31)
- ⑤ Rank: Chromaticity rank is indicated as follows;  
Rank 1 → 1

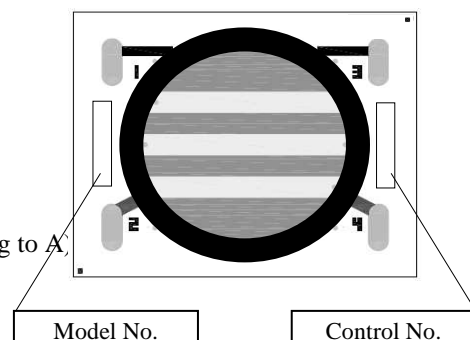

## 7. Precautions

### ① Storage conditions

Please follow the conditions below.

- Before opened: Temperature 5 ~ 30 °C, Relative humidity less than 60 %.  
(Before opened LED should be used within a year)
- After opened: Temperature 5 ~ 30 °C, Relative humidity less than 60 %.  
(Please use it promptly after opened. )
- After opened LED should be kept in an aluminum moisture proof bag with a moisture absorbent material (silica gel).
- Avoid exposing to air with corrosive gas.

### ② Usage conditions

This product is not designed for the use under any of the following conditions.

Please confirm performance and reliability well enough if you use under any of the following conditions;

- In a place with a lot of moisture, dew condensation, briny air, and corrosive gas.  
(Cl, H<sub>2</sub>S, NH<sub>3</sub>, SO<sub>2</sub>, NOX, etc.)
- Under the direct sunlight, outdoor exposure, and in a dusty place.
- In water, oil, medical fluid, and organic solvent.
- Please do not use component parts like rubber which may contain sulfur (gasket packing, adhesive material, etc.).

### ③ Heat radiation and Installation

If forward current (IF) is applied to single-state module at any current, there is a risk of damaging LED or emitting smoke, due to increase in temperature.

Equip with specified heat radiator(heat sink), and avoid heat being stuffed inside the module.

Material of substrate is alumina ceramic. If installed inappropriately, trouble of insufficient heat radiation may occur , which may result in board cracks or lighting defects due to overheat. Please take particular notice for installation.

Refer to the following cautions while installing the LED device on heat sink.

- Apply thermolysis adhesive, adhesive sheet or peculiar connector when mounted on heat radiator.  
In case of applying adhesive or adhesive sheet only, check the effectiveness and reliability before fixing.  
If LED comes off from heat radiator, unusual temperature rise entails hazardous phenomena including device deterioration, and emitting smoke, along with LED device deffects.
- When LED device is mechanically fixed or locked, Please take into consideration regarding the method of attachment due to fail from stress.
- Avoid convexly uneven boards.  
Convex board is subject to substrate cracking or debasement of heat release.
- It is recommended to apply adhesive or adhesive sheet with high thermal conductivity for radiation of heat effectively.
- Please take care about the influence of color change of adhesive or adhesive sheet in initial and long term period, which may affect light output or color due to change of reflectance from backside.

- Do not touch resin part including white resin part on the surface of LED.  
No light emission may occur due to damage of resin or cutting wire of LEDs by outer force.  
When using tweezers, please handle by ceramic substrate part and avoid touching resin part.  
For mounting, please handle by side part of ceramic or the specified area shown below.

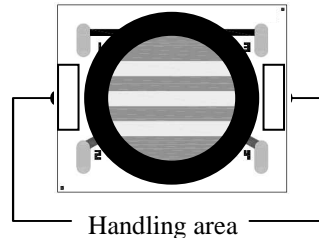

- The outer edges of the substrate may be uneven in some cases. Please avoid choosing these areas as fixing points, while designing for installation.
- In case of using heat radiation sheet or heat radiation adhesive, light reflection or absorption of these materials may influence the output of LED device. Especially, the color change that occur due to long-term use has direct impact on output of LED devices, and hence careful consideration is required while choosing the radiation sheet or adhesive.

#### ④ Connecting method

- This product is designed only for contact connection, and not designed for soldered connections.
- In case of solder connection, please use the LED device that supports solder joint.
- In case of contact connection, check whether the connection is done properly, and also carefully check the reliability before using.

#### ⑤ Static electricity

This product is subject to static electricity, so take measures like wearing wrist band to cope with it. Install circuit protection device to drive circuit, if necessary.

#### ⑥ Drive method

- Any reverse voltage cannot be applied to LEDs when they are in operation or not.  
Design a circuit so that any flow of reverse or forward voltage can not be applied to LEDs when they are out of operation.
- Module is composed of LEDs connected in both series and parallel.  
Constant voltage power supply runs off more than specified current amount due to lowered VF caused by temperature rise. Constant current power supply is recommended to drive.
- Be cautious while putting on/off the power supply, as excess current, excess voltage or reverse voltage may get injected to the device in some cases.

**⑦ Cleaning**

Avoid cleaning, since LED device may be effected in some cases by cleaning.

**⑧ Color-tone variation**

Chromaticity of this product is monitored by integrating sphere right after the operation.

Chromaticity varies depending on measuring method, light spread condition, or ambient temperature.

Please verify your actual conditions before use.

**⑨ Safety**

• Looking directly at LEDs for a long time may result in hurting your eyes.

• In case that excess current (over ratings) is supplied to the device, hazardous phenomena including abnormal heat generation, emitting smoke, or catching fire can be caused.

Take appropriate measures to excess current and voltage.

• Please confirm the safety standards or regulations of application devices.

• Please be careful with substrate edges, that may injure your hands.

**⑩ Other cautions**

Guarantee covers the compliance to the quality standards mentioned in the specifications, however it does not cover the compatibility with application of the end-use, including assembly and usage environment.

In case any quality problems occurred in the application of end-use, details will be separately discussed and determined between the parties hereto.

## 8. Characteristics diagram (TYP.)

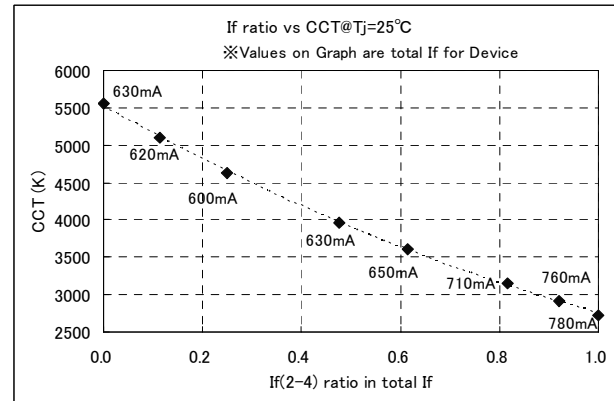
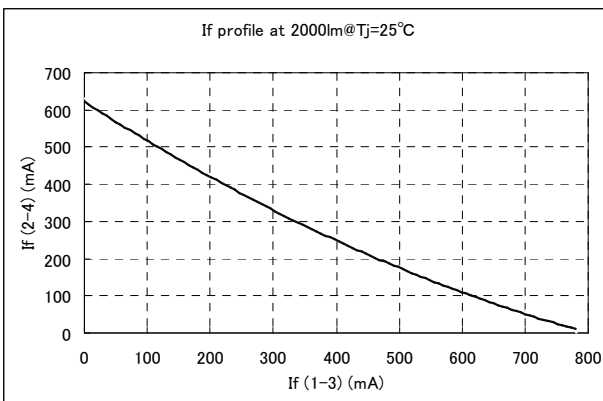
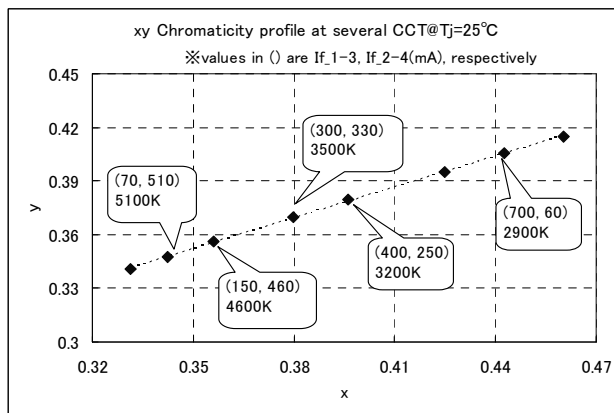
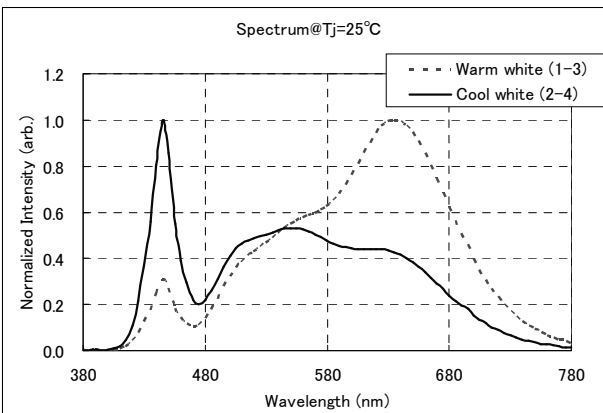
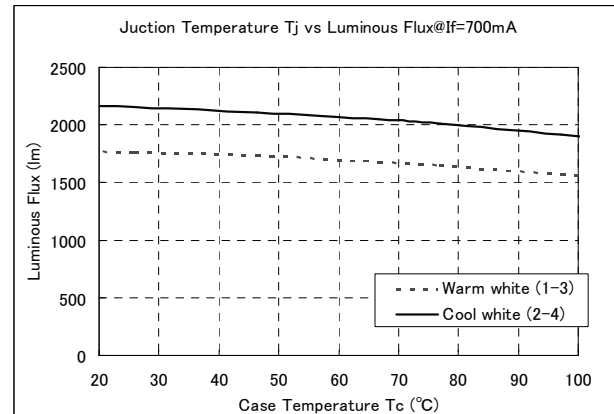
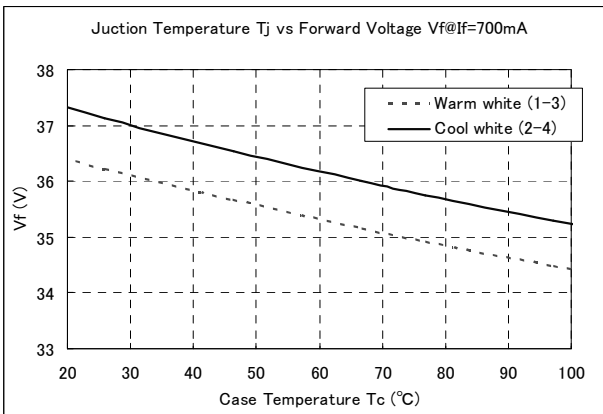
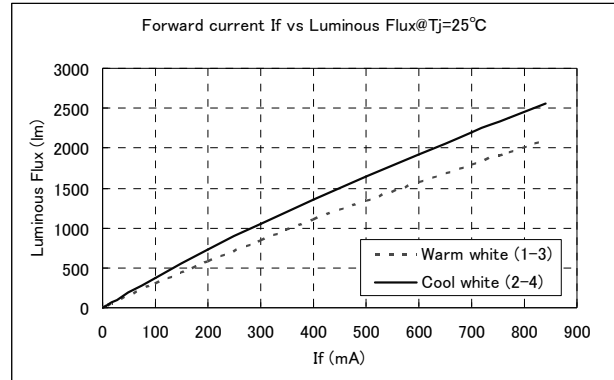
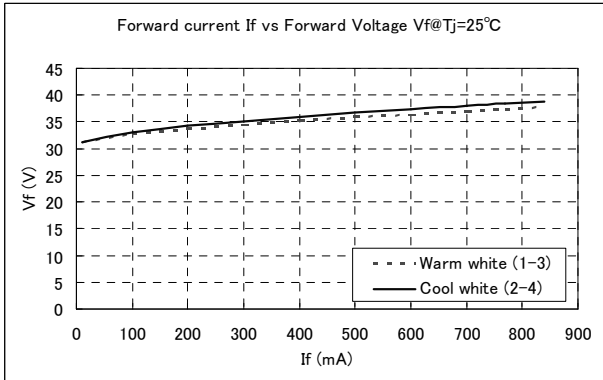

(Note) Characteristics data shown here are for reference purpose only. (Not guaranteed data)