

MATERIAL NO.	ENGINEERING NO.	LENGTH	POLES
1206130001	LWLW3030K05M010	39.4 (1M)	3
1206130002	LWLW4030K05M010	39.4 (1M)	4

NOTICE: THIS PART IS CSA AND FACTORY MUTUAL APPROVED
NO CHANGES CAN BE MADE TO THE ASSEMBLY, COMPONENTS
OR SUPPLIER WITHOUT PRIOR APPROVAL FROM CSA AND
FACTORY MUTUAL.

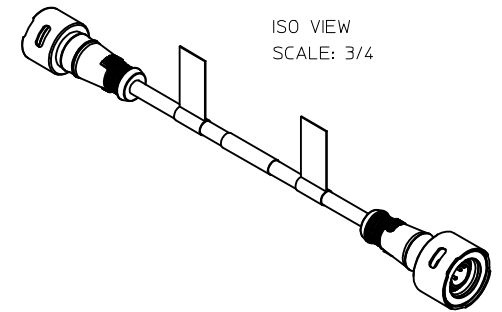

Ⓑ LWLWX030K05MXXX

DOUBLE END
POLE QTY.
HEAD STYLE (S)
CABLE TYPE
FINISHED LENGTH
REF. XXX = METERS
EXAMPLE 010= 1M

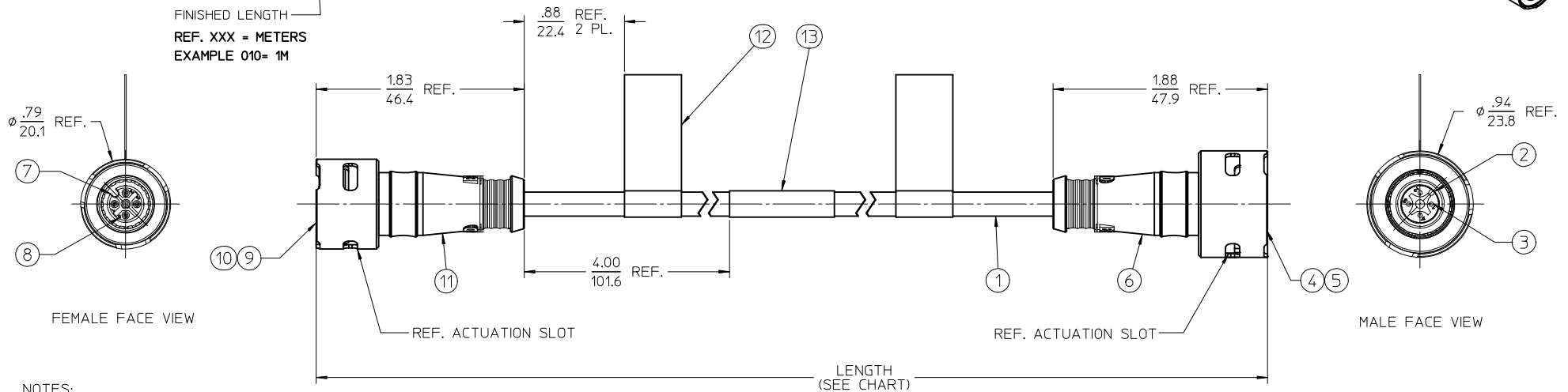

- NOTES:
1. MATERIAL: SEE TABLE
 2. FINISHES: SEE TABLE
 3. PRODUCT SPECIFICATIONS: PS-120614-001
 4. CONTROL DOC: ES-120614-001
 - 3 & 4 POLE ELECTRICAL SPECIFICATIONS:
VOLTAGE RATING: 125V
CURRENT RATING: 4 AMPS
 - 5 POLE ELECTRICAL SPECIFICATIONS:
VOLTAGE RATING: 32V
CURRENT RATING: 4 AMPS

FEMALE FACE VIEW			MALE FACE VIEW		
3 POLE	4 POLE	5 POLE	3 POLE	4 POLE	5 POLE
1 BROWN 2 NOT USED 3 BLUE 4 BLACK 5 NOT USED	1 BROWN 2 WHITE 3 BLUE 4 BLACK 5 NOT USED	1 BROWN 2 WHITE 3 BLUE 4 BLACK 5 GRAY	1 BROWN 3 BLUE 4 BLACK	1 BROWN 2 WHITE 3 BLUE 4 BLACK	1 BROWN 2 WHITE 3 BLUE 4 BLACK 5 GRAY

ITEM	QTY.	DESCRIPTION	MATERIAL	FINISH
13	1	WRAP LABEL	PLASTIC FILM	BLACK/YELLOW
12	2	FLAG LABEL (WARNING)	POLYESTER	BLACK/ORANGE
11	1	OVERMOLD, FEMALE	TPE	YELLOW
10	1	OUTER SLEEVE, FEMALE	ST. STEEL	PASSIVATED
9	1	INNER SLEEVE, FEMALE	ST. STEEL	PASSIVATED
8	XX	CONTACT SOCKET	Cu ALLOY	GOLD PLATED
7	1	INSERT, FEMALE	PUR	BLACK
6	1	OVERMOLD, MALE	TPE	YELLOW
5	1	OUTER SLEEVE, MALE	ST. STEEL	PASSIVATED
4	1	INNER SLEEVE, MALE	ST. STEEL	PASSIVATED
3	XX	CONTACT PIN	Cu ALLOY	GOLD PLATED
2	1	INSERT, MALE	PUR	BLACK
1	1	CABLE, #22 AWG ITC/PLTC	TPE	YELLOW

ADDED P/N LEGEND EC NO: IPG2014-0138 DRAWN BY: DRWINRSTONE 2013/07/24 CHK'D BY: WOODMAN 2013/08/01 APPR: BWOODMAN 2013/12/30	QUALITY SYMBOLS ▽=0 ▽=0	GENERAL TOLERANCES (UNLESS SPECIFIED) <table border="1"> <tr> <th></th> <th>mm</th> <th>INCH</th> </tr> <tr> <td>4 PLACES ±</td> <td>---</td> <td>±---</td> </tr> <tr> <td>3 PLACES ±</td> <td>---</td> <td>±---</td> </tr> <tr> <td>2 PLACES ±</td> <td>---</td> <td>±.01</td> </tr> <tr> <td>1 PLACE ±</td> <td>0.3</td> <td>±---</td> </tr> </table> ANGULAR ± 2°		mm	INCH	4 PLACES ±	---	±---	3 PLACES ±	---	±---	2 PLACES ±	---	±.01	1 PLACE ±	0.3	±---	DIMENSION STYLE IN/MM	SCALE 1.5:1	DESIGN UNITS INCH	THIRD ANGLE PROJECTION
				mm	INCH																
4 PLACES ±	---	±---																			
3 PLACES ±	---	±---																			
2 PLACES ±	---	±.01																			
1 PLACE ±	0.3	±---																			
DRAWN BY: RSTONE DATE: 2011/11/21 CHECKED BY: L.HARTMANN DATE: 2012/01/27 APPROVED BY: JFMURPHY DATE: 2012/04/18	SEE CHART		MOLEX INCORPORATED		ULTRA-LOCK ZONE 2 MALE TO FEMALE STRAIGHT K05, 22 AWG, TPE																
DRAFT WHERE APPLICABLE MUST REMAIN WITHIN DIMENSIONS			MATERIAL NO. SD-120613-001	DOCUMENT NO.	SHEET NO. 1 OF 1	THIS DRAWING CONTAINS INFORMATION THAT IS PROPRIETARY TO MOLEX INCORPORATED AND SHOULD NOT BE USED WITHOUT WRITTEN PERMISSION															

DRAWING NO.	DESCRIPTION	FINISHED GOOD REV. LEVEL
LWR000A18	MIC U-LOCK ZONE 2 RECEPT ASSY, FEM. 1/2 NPT, 22 AWG	C
LWR006A18	MIC U-LOCK ZONE 2 RECEPT ASSY, MALE 1/2 NPT, 22 AWG	B
LWRA00A18	MIC U-LOCK ZONE 2 RECEPT ASSY, FEM. 1/4 NPT, 22 AWG	C
LWRA06A18	MIC U-LOCK ZONE 2 RECEPT ASSY, MALE 1/4 NPT, 22 AWG	B
LWR000A16	MIC U-LOCK ZONE 2 RECEPT ASSY, FEM. 1/2 NPT, 18 AWG	B
LWR006A16	MIC U-LOCK ZONE 2 RECEPT ASSY, MALE 1/2 NPT, 18 AWG	B
LWXXXXXC02XXXX	U-LOCK ZONE 2 C02 CORD ASSY, 18AWG SJ00W, DC COLOR	C
LWXXXXXK03XXXX	U-LOCK ZONE 2 K03 CORD ASSY, 18AWG TPE, DC COLOR	C
LWXXXXXK05XXXX	U-LOCK ZONE 2 K05 CORD ASSY, 22AWG TPE, DC COLOR	C
SD-120614-999	CONTROL DOC FOR ULTRA-LOCK ZONE 2	D

PRELIMINARY EC NO: IPG2016-0500 DRAWN: RSTONE 2016/03/07 CHKD: WAI LEUNG 2016/05/20 APPR: JFMURPHY 2016/05/20	QUALITY SYMBOLS	GENERAL TOLERANCES (UNLESS SPECIFIED)		DIMENSION STYLE IN/MM		SCALE 1:1	DESIGN UNITS INCH	THIRD ANGLE PROJECTION	
	▽=0	4 PLACES	mm	INCH	DRAWN BY	DATE	TITLE SCHEDULE DRAWING FOR ULTRA LOCK ZONE 2		
	∇=0	3 PLACES	± ---	± ---	RSTONE	2016/03/07			
		2 PLACES	± ---	± ---	CHECKED BY	DATE	molex DOCUMENT NO. SD-120614-998 SHEET NO. 1 OF 1		
		1 PLACE	± ---	± ---	WAI LEUNG				
	0 PLACE	± ---	± ---	APPROVED BY	DATE				
			ANGULAR ± ---°		JFMURPHY	2016/05/20			
			DRAFT WHERE APPLICABLE MUST REMAIN WITHIN DIMENSIONS		MATERIAL NO.	-			
					SIZE	B	THIS DRAWING CONTAINS INFORMATION THAT IS PROPRIETARY TO MOLEX INCORPORATED AND SHOULD NOT BE USED WITHOUT WRITTEN PERMISSION		

CLASS 1, DIVISION 2, GROUP A, B, C, OR D
HAZARDOUS LOCATION

NON-HAZARDOUS LOCATION

CLASS 1, DIVISION 2, GROUP A, B, C, OR D
HAZARDOUS LOCATION

NON-HAZARDOUS LOCATION

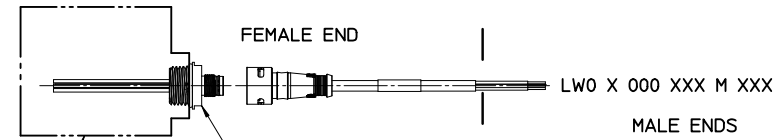

LWR X 006 A18 CXXX
(MALE 1/2" NPT)
LWR X A06 A18 CXXX
(MALE 1/4" NPT)

LW0 X 000 XXX M XXX

MALE ENDS

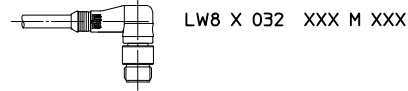

LW8 X 032 XXX M XXX

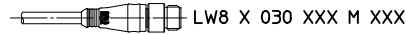

LW8 X 030 XXX M XXX

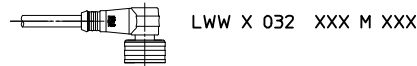

LWW X 032 XXX M XXX

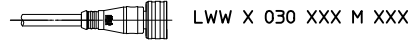

LWW X 030 XXX M XXX

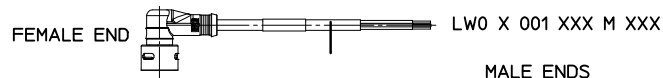

LW0 X 001 XXX M XXX

MALE ENDS

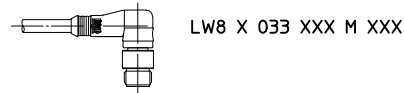

LW8 X 033 XXX M XXX

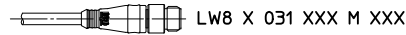

LW8 X 031 XXX M XXX

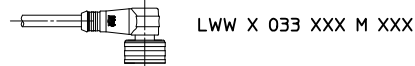

LWW X 033 XXX M XXX

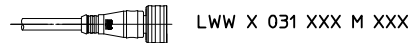

LWW X 031 XXX M XXX

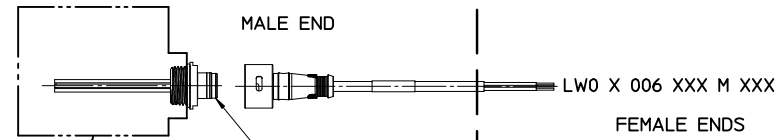

LWR X 000 A18 CXXX
(FEMALE 1/2" NPT)
LWR X A00 A18 CXXX
(FEMALE 1/4" NPT)

LW0 X 006 XXX M XXX

FEMALE ENDS

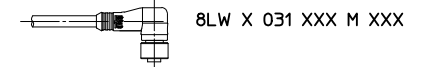

8LW X 031 XXX M XXX

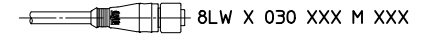

8LW X 030 XXX M XXX

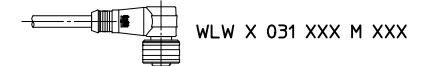

WLW X 031 XXX M XXX



WLW X 030 XXX M XXX

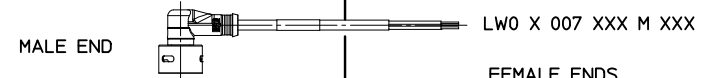

LW0 X 007 XXX M XXX

FEMALE ENDS

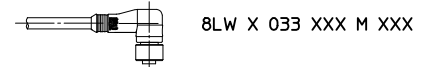

8LW X 033 XXX M XXX

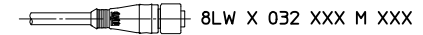

8LW X 032 XXX M XXX

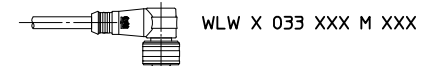

WLW X 033 XXX M XXX



WLW X 032 XXX M XXX

NOTICE: THIS PART IS CSA AND FACTORY MUTUAL APPROVED
NO CHANGES CAN BE MADE TO THE ASSEMBLY, COMPONENTS
OR SUPPLIER WITHOUT PRIOR APPROVAL FROM CSA AND
FACTORY MUTUAL.

- NOTES:
1. THE INSTALLATION MUST BE IN ACCORDANCE WITH THE NATIONAL ELECTRICAL CODE (NEC), ANSI/NFPA 70. SPECIFIC REQUIREMENTS FOR THE INSTALLATION OF ITC RATED CABLE MAY BE FOUND IN ARTICLE 501.4(B)(1)(5) AND ARTICLE 727.4
 2. THE MOLDED CONSTRUCTION OF THE CORDSET AND GAS/VAPORTIGHT CONTINUOUS SHEATH OF THE CABLE MEET THE REQUIREMENTS OF THE NEC, ARTICLE 501-5(E)(2) FOR CABLE SEALS IN CLASS 1, DIVISION 2
- ⚠ FIELD DEVICE APPROVAL FOR CLASS 1, DIV. 2 OR CLASS 1, ZONE2 INSTALLATIONS
4. ATEX cert no: ATEX FM15ATEX0048X IECEx FMG 15.0012X Ⓢ

REF. SEE SHEET 3 FOR CONFIGURATION INFORMATION

THIS DRAWING SUPERSEDES ES-120614-001 REV-B

ADDED NOTE 4 EC NO: IPG2016-0500 DRAWNRSTONE 2015/10/16 CHKD:WAI LEUNG 2016/05/20 APPR:JFMURPHY 2016/05/20 REV D	QUALITY SYMBOLS ▽=0 ▽=0	GENERAL TOLERANCES (UNLESS SPECIFIED)		DIMENSION STYLE IN/MM		SCALE 1:1	DESIGN UNITS INCH	THIRD ANGLE PROJECTION		
				DRAWN BY RSTONE		DATE 2012/05/18	TITLE CONTROL DOC FOR ULTRA-LOCK ZONE 2			
				CHECKED BY K JOZWIK		DATE 2012/05/22				
				APPROVED BY JFMURPHY		DATE 2012/08/27	MATERIAL NO. 1206149999		DOCUMENT NO. SD-120614-999	
		DRAFT WHERE APPLICABLE MUST REMAIN WITHIN DIMENSIONS		SIZE C		THIS DRAWING CONTAINS INFORMATION THAT IS PROPRIETARY TO MOLEX INCORPORATED AND SHOULD NOT BE USED WITHOUT WRITTEN PERMISSION				

CLASS 1, DIVISION 2, GROUP A, B, C, OR D
HAZARDOUS LOCATION

HAZARDOUS LOCATION

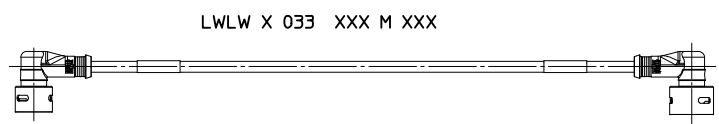
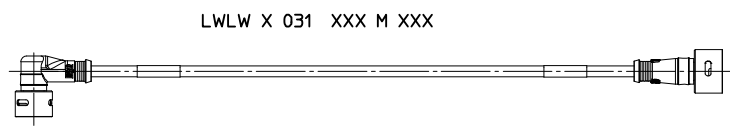
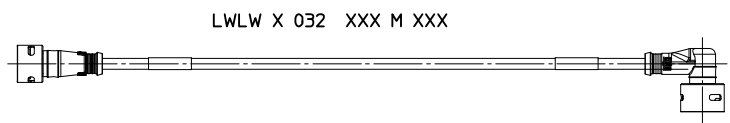
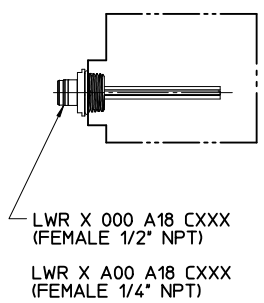
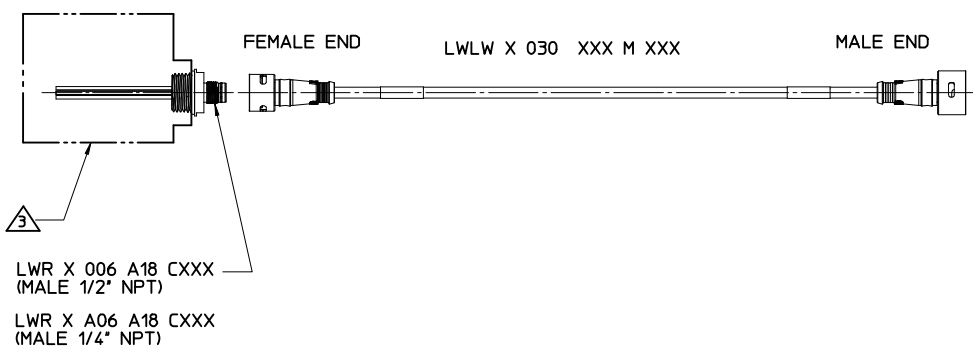

- REF:
1. SEE SHEET 1 FOR NOTES
 2. SEE SHEET 3 FOR CONFIGURATION INFORMATION

NOTICE: THIS PART IS CSA AND FACTORY MUTUAL APPROVED
NO CHANGES CAN BE MADE TO THE ASSEMBLY, COMPONENTS
OR SUPPLIER WITHOUT PRIOR APPROVAL FROM CSA AND
FACTORY MUTUAL.

SEE SHEET 1 EC NO: JFG2016-0500 DRAWNRSTONE 2015/10/16 CHKD:WAI LEUNG 2016/05/20 APPR:JFMURPHY 2016/05/20	QUALITY SYMBOLS ▽=0 ▽=0	GENERAL TOLERANCES (UNLESS SPECIFIED)		DIMENSION STYLE IN/MM		SCALE 1:1	DESIGN UNITS INCH	THIRD ANGLE PROJECTION		
			mm	INCH	DRAWN BY RSTONE	DATE 2012/05/18	TITLE CONTROL DOC FOR ULTRA-LOCK ZONE 2			
		4 PLACES ± ---	± ---	± ---	CHECKED BY K JOZWIK	DATE 2012/05/22				
		3 PLACES ± ---	± ---	± ---	APPROVED BY JFMURPHY	DATE 2012/08/27	MATERIAL NO. 1206149999		DOCUMENT NO. SD-120614-999	
	ANGULAR ± ---°		DRAFT WHERE APPLICABLE MUST REMAIN WITHIN DIMENSIONS		THIS DRAWING CONTAINS INFORMATION THAT IS PROPRIETARY TO MOLEX INCORPORATED AND SHOULD NOT BE USED WITHOUT WRITTEN PERMISSION					

M12/MICROCHANGE ULTRA-LOCK CORD CONNECTORS AND CORD SETS

LWO 3 000 C02 M 020 8
 I II III IV V VI VII

I: CONNECTOR TYPE

LWO= ULTRA-LOCK ZONE 2 MALE OR FEMALE SINGLE END CORDSET
 LWW= ULTRA-LOCK ZONE 2 FEMALE TO STANDARD ULTRA-LOCK MALE DOUBLE ENDED CORDSET
 WLW= ULTRA-LOCK ZONE 2 MALE TO STANDARD ULTRA-LOCK FEMALE DOUBLE ENDED CORDSET
 LW8= ULTRA-LOCK ZONE 2 FEMALE TO STANDARD M12 MALE DOUBLE ENDED CORDSET
 8LW= ULTRA-LOCK ZONE 2 MALE TO STANDARD M12 FEMALE DOUBLE ENDED CORDSET
 LWLW= ULTRA-LOCK ZONE 2 FEMALE TO ULTRA-LOCK ZONE 2 MALE DOUBLE ENDED CORDSET

II: NUMBER OF POLES: 3= 3 PIN, 4= 4 PIN, 5 = 5 PIN

III: CONFIGURATION

SINGLE ENDED:
 000= STRAIGHT FEMALE CONNECTOR
 001= FEMALE 90°
 006= STRAIGHT MALE, EXTERNAL THREAD
 007= MALE 90°

DOUBLE ENDED:

030= STRAIGHT FEMALE CONNECTOR TO STRAIGHT MALE CONNECTOR
 031= FEMALE 90° TO MALE STRAIGHT
 032= FEMALE STRAIGHT TO MALE 90°
 033= FEMALE 90° TO MALE 90°

IV: CABLE TYPE

C02= SJ00W YELLOW, 18 AWG, DC CODE
 K03= PLTC/ITC, 18 AWG, TPE JACKET
 K05= PLTC/ITC, 22 AWG, TPE JACKET

V: UNIT OF MEASURE

F= FEET
 M= METERS

VI: CABLE LENGTH (MAY BE ANY 3 DIGIT NUMBER FROM 001-100)

1ST DIGIT= 10 X LENGTH
 2ND DIGIT= 1 X LENGTH
 3RD DIGIT= .1 X LENGTH

VII: COUPLING NUT MATERIAL

ULTRA-LOCK ZONE 2 END(S) ARE STAINLESS STEEL

M12 OR ULTRA-LOCK:

NONE = STANDARD MATERIAL (NICKEL PLATED BRASS)
 8= STAINLESS STEEL

**NOTICE: THIS PART IS CSA AND FACTORY MUTUAL APPROVED
 NO CHANGES CAN BE MADE TO THE ASSEMBLY, COMPONENTS
 OR SUPPLIER WITHOUT PRIOR APPROVAL FROM CSA AND
 FACTORY MUTUAL.**

M12/MICROCHANGE ULTRA-LOCK OUTLETS

LWR 3 A00 A18 M 020 8
 I II III IV V VI VII

I: CONNECTOR TYPE

LWR= LOCKING INLETS AND OUTLETS

II: NUMBER OF POLES 3=3 PIN, 4= 4 PIN, & 5= 5 PIN

III: CONFIGURATION

SINGLE ENDED:
 A00= FEMALE STRAIGHT (INT.THEAD) 1/4-18 NPT
 A06= MALE STRAIGHT (EXT.THEAD) 1/4-18 NPT
 000= FEMALE STRAIGHT (INT.THEAD) 1/2-14 NPT
 006= MALE STRAIGHT (EXT.THEAD) 1/2-14 NPT

IV: WIRE TYPE

A18= 22 AWG, PVC, DC COLOR CODE, UL TYPE 1061
 A16= 18 AWG, PVC, DC COLOR CODE, UL TYPE 1569
 000= PCB PINS
 000= PCB PINS

V: UNIT OF MEASURE

A= INCHES
 F= FEET
 C= CENTIMETERS
 M= METERS

VI: WIRE LENGTH (MAY BE ANY 3 DIGIT NUMBER FROM 001-100)

1ST DIGIT= 10 X LENGTH
 2ND DIGIT= 1 X LENGTH
 3RD DIGIT= .1 X LENGTH

VII: SHELL MATERIAL

M12 OR ULTRA-LOCK:
 NONE = STANDARD MATERIAL (COPPER ZINC ALLOY)
 3= NICKEL PLATED BRASS
 8= STAINLESS STEEL

SEE SHEET 1 EC NO: IPG2016-0500 D/DRUMHRSTONE 2015/10/16 CHKD:WAI LEUNG 2016/05/20 APPR: JFURPHY 2016/05/20	QUALITY SYMBOLS	GENERAL TOLERANCES (UNLESS SPECIFIED)	DIMENSION STYLE	SCALE	DESIGN UNITS	THIRD ANGLE PROJECTION
	▽=0 ▽=0	mm	IN/MM	1:1	INCH	CONTROL DOC FOR ULTRA-LOCK ZONE 2
		INCH	IN/MM			
	DESCRIPTION	4 PLACES ±--- ±--- 3 PLACES ±--- ±--- 2 PLACES ±--- ±--- 1 PLACE ±--- ±--- ANGULAR ±---°	DRAWN BY DATE RSTONE 2012/05/18 CHECKED BY DATE K JOZWIK 2012/05/22 APPROVED BY DATE JFMURPHY 2012/08/27	TITLE	MOLEX INCORPORATED	
REV	DRAFT WHERE APPLICABLE MUST REMAIN WITHIN DIMENSIONS	MATERIAL NO.	DOCUMENT NO.	SHEET NO.		
		1206149999	SD-120614-999	3 OF 3		
		THIS DRAWING CONTAINS INFORMATION THAT IS PROPRIETARY TO MOLEX INCORPORATED AND SHOULD NOT BE USED WITHOUT WRITTEN PERMISSION				