

LOC	DIST	REVISIONS					
E	B	P	LTR	DESCRIPTION	DATE	DWN	APVD
			BA	NEW RELEASE	22-OCT-09	MRS	St.P

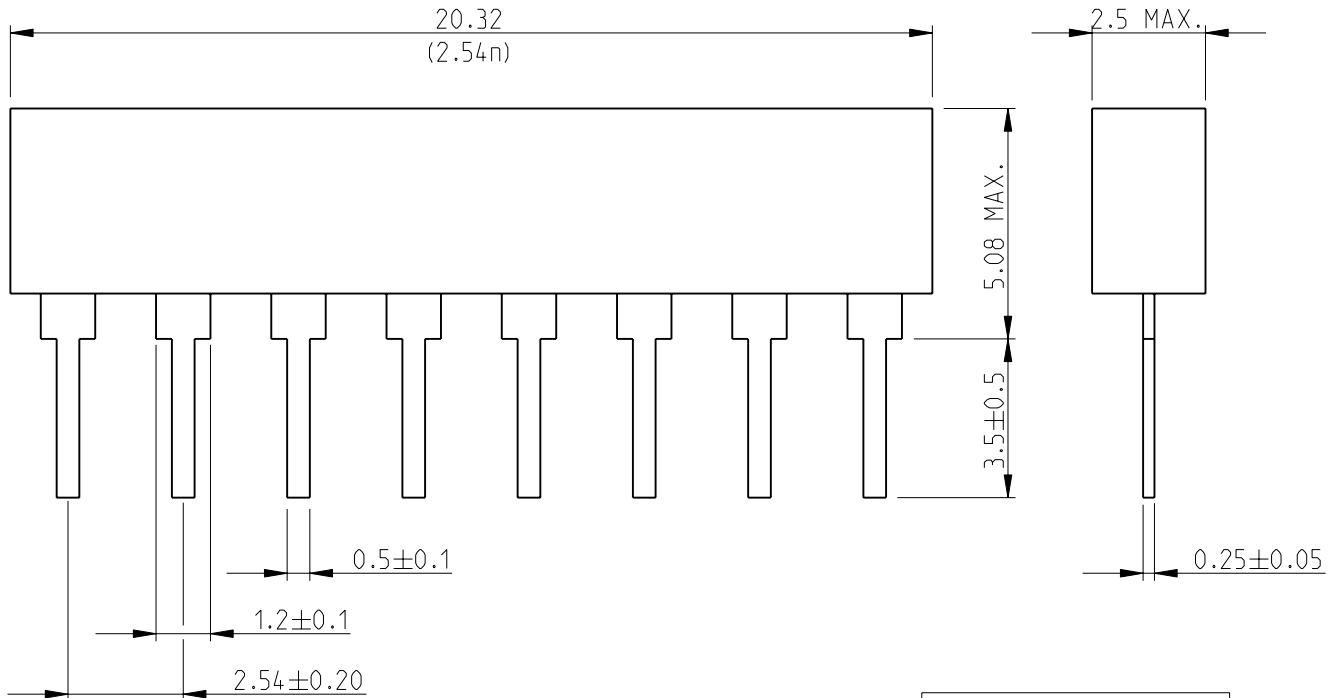

RoHS Compliant

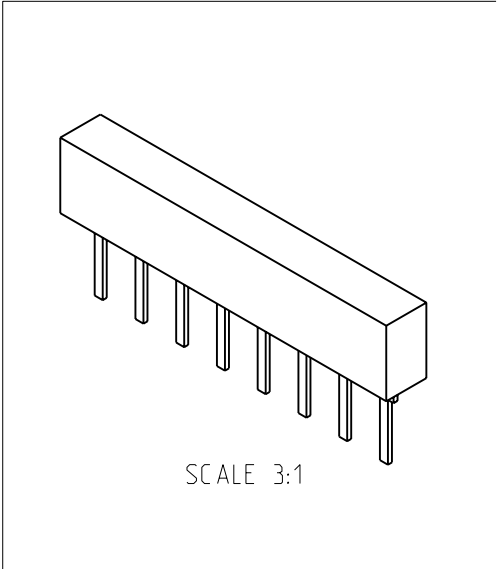

1. n = NUMBER OF PINS
2. FOR FURTHER INFORMATION SEE DATA SHEET FOR SERIES SIL, GENERAL PURPOSE RESISTOR NETWORKS

2009

RELEASED FOR PUBLICATION

THIS DRAWING IS UNPUBLISHED.

BY TYCO ELECTRONICS CORPORATION. ALL RIGHTS RESERVED.



DIMENSIONS: mm	DWN MAHARUDRA	22-OCT-09	MATERIAL	-	FINISH	-
	CHK ALLAN.P	22-OCT-09	Tyco Electronics Corporation Dorcan, Swindon, SN3 5HH			
TOLERANCES UNLESS OTHERWISE SPECIFIED:	APVD STEPHEN.P	22-OCT-09				
0 PLC ±0.2	PRODUCT SPEC	-	NAME GENERAL PURPOSE RESISTOR NETWORKS SIL08 RESISTOR NETWORKS			
1 PLC ±0.1	APPLICATION SPEC	-	SIZE	CAGE CODE	DRAWING NO	RESTRICTED TO
2 PLC ±-			A 4	00779	©= 1622805	-
3 PLC ±-			CUSTOMER DRAWING			
4 PLC ±-	WEIGHT	-	SCALE	6:1	SHEET 1 OF 1	REV BA
ANGLES ±5°						