

Assembly Instructions for - 37387

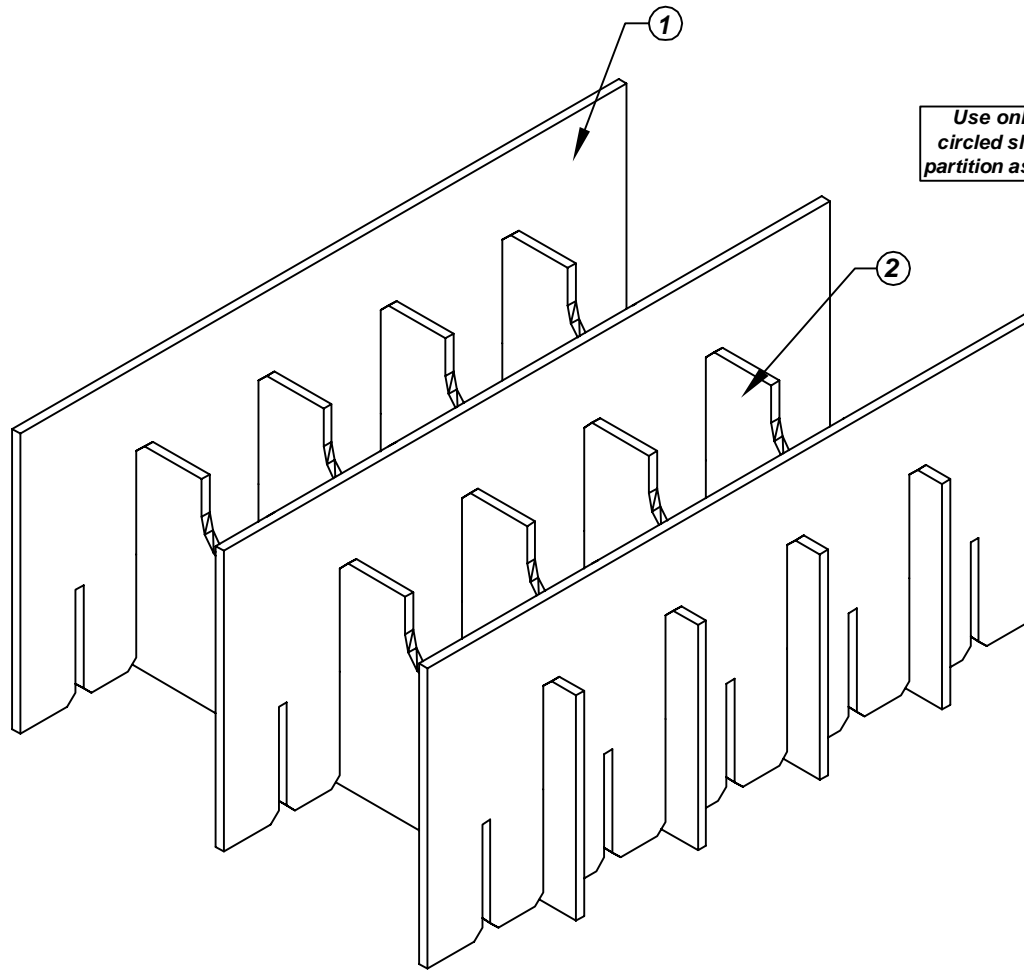

Use only the circled slots for partition assembly

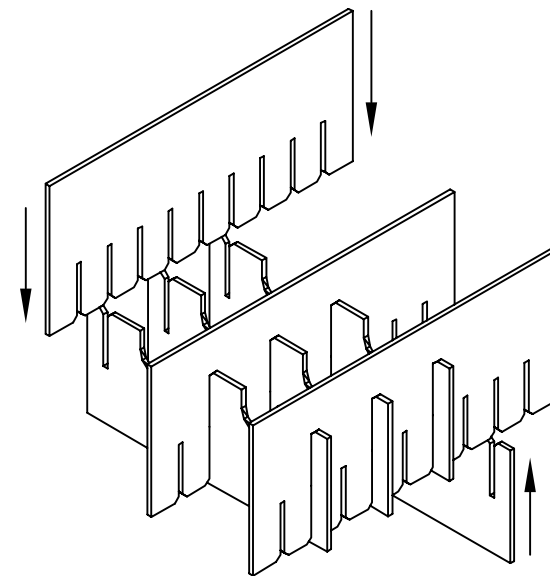
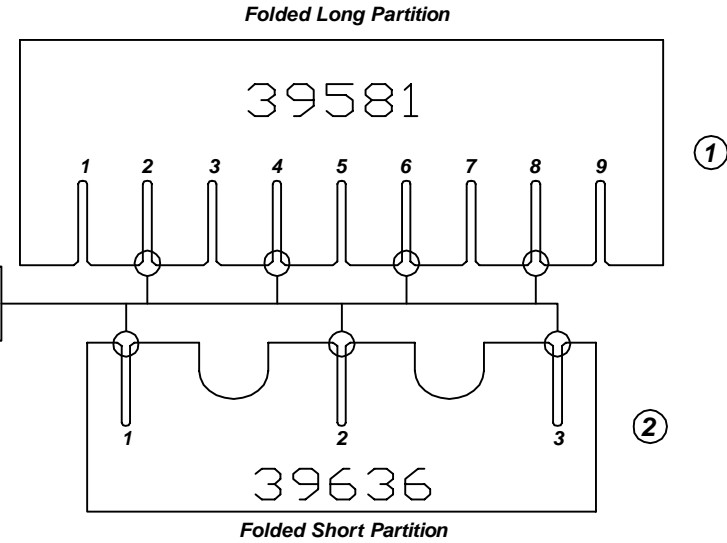

Made in America

F/N ①	Part # 39581	Dimensions: 16-1/4" x 18-5/8"	Description: 468-HLP-10 Long Partition	Qty: 3
F/N ②	Part # 39636	Dimensions: 12" x 14-3/4"	Description: 406/468-HSP Short Partition	Qty: 4

37387 - 10 Cell Inplant Handler Cell Size - 8" x 6-1/4" x 3-5/8"

Notes:
For use with the following storage container & lid:
37527 - Storage Container
37554 - Lid

PROTEKTIVE PAK
13520 MONTE VISTA AVENUE, CHINO, CA 91710
PHONE (909) 627-2578, FAX (909) 363-7331
ProtektivePak.com



DRAWING NUMBER
IPH-37387

DATE
Nov.
2007