

Coiltronics®

# High Frequency Inductor Catalog

Magnetics for Power Management

## Magnetics Products for Power Management

### Table of Contents

Inductor Series	Size (mm)	Page
FP0705	7 x 7 x 5	4
FP0708	7 x 8.5 x 7.2	7
FP0805	7.5 x 7.6 x 5	10
FP0807	7.4 x 7.6 x 7	13
FP1005	7 x 10.2 x 5	16
FP1006	8 x 10 x 6	19
FP1007	8 x 10.4 x 7	22
FP1105	8 x 11 x 5	25
FP1107	7.2 x 11 x 7.5	28
FP1109	11 x 11 x 9	31
FP1308	13 x 13.7 x 9	34
FP3	6.7 x 7.2 x 3	37
HCP0704	6.8 x 6.8 x 4.2	39
HCP0805	7.4 x 7.7 x 5	42
<b>Inductor Solder Profile (all Series)</b>		<b>45</b>
<b>Application Notes</b>		
High Frequency Inductors for Core Power Applications		46
Power Inductors Improve Reliability in High Temperature Designs		49
Inductor Selection for Switching Regulators		51
<b>Online Resources</b>		<b>55</b>

### Leading-Edge Technology

The Cooper Bussmann Coiltronics® brand specializes in standard and custom solutions offering the latest in state-of-the-art low-profile high power density magnetic components. In working closely with the industry leaders in chipset and core development, we remain at the forefront of innovation and new technology to deliver the optimal mix of packaging, high efficiency and unbeatable reliability. Our designs utilize high frequency, low core loss materials, new and custom core shapes in combination with innovative construction and packaging to provide designers with the highest performance parts available on the market.

### Market-Driven Products

The Coiltronics brand is the first choice in power inductor and transformer solutions to the ever-changing digital home, office and mobile electronics world. In support of this market, we specialize in inductors and transformers for DC-DC power conversion and switch-mode applications requiring high frequency. Our component solutions can be found in many products requiring power conversion including cellular telephones, digital cameras, MP3 players, notebook and desktop computers and peripherals and LCD displays across the consumer, communication, computer, industrial and automotive markets.

### Standard Products

The Coiltronics brand product line of power magnetics continually expands to satisfy shifts in technology and related market needs. Categories of Standard Products include:

- High frequency, high current inductors
- Shielded drum inductors
- Unshielded drum inductors
- Common-mode inductors
- Transformers
- Low-profile shielded drum inductors
- High current inductors
- Toroidal inductors
- Custom magnetics

### Custom-Engineered Capabilities

- Inductors and transformers for DC-DC converters and off-line switch mode power supplies (to 200 Watts at voltages up to 450Vac [640Vdc] and frequencies from 20kHz to 10MHz)
- Custom SMT inductors and transformers

Coiltronics products can provide you with custom designs from print through manufacture. Our design engineers can take your designated specifications or help you determine what the specifications should be. Either way, we'll get you the right power magnetic solution to your design challenge.

### Halogen Free

Cooper Bussmann is committed to meeting the anticipated requirements on the use of halogens. Currently in place is a *Halogen Free Initiative* for all Coiltronics® branded inductors and transformers. We are committed to phasing out the use of halogenated materials by the end of calendar year 2009. "Halogen free" is defined by homogeneous material per industry standard IPC (IEC 61249-2-21) with the following threshold limits: Chlorine (Cl) <900ppm, Bromine (Br) <900ppm and Chlorine (Cl) + Bromine (Br) <1500ppm.

### NEW High Frequency Inductors for Core Power Applications

New in this catalog are 12 Coiltronics® high frequency inductor series with a wide range of sizes, current range and DCR tolerance options. They utilize controlled DCR tolerance needed for DCR sensing circuits and are well suited for capturing the demands of core power and DCR current sensing applications. Their high saturation, low loss and wide temperature range core material make them ideally suited for the demands of core power purposes.

### Features:

- Halogen free
- Large variety of shapes and sizes
- Ferrite and powder iron core material models available
- Controlled DCR for DCR sensing circuits
- High current carrying capacity, low core losses
- RoHS compliant

### Standard Product Families:

FP0705, FP0708, FP0805, FP0807, FP1005, FP1006, FP1007, FP1105, FP1107, FP1109, HCP0704, HCP0805

Cooper Bussmann circuit protection solutions comply with major industrial standards and agency requirements such as: BS, IEC, DIN, UL, NEMA, SAE, CSA, CE, C-UL, etc. and are manufactured at facilities that are ISO 9000 certified. This catalog is intended to present product data and provide technical information that will help the end user with design application. Cooper Bussmann reserves the right, without notice, to change design or construction of any products and to discontinue or limit distribution of any products. Cooper Bussmann also reserves the right to change or update, without notice, any technical information contained in this catalog. Once a product has been selected, it should be tested by the user in all possible applications. Further, Cooper Bussmann takes no responsibility for errors or omissions contained in this catalog, or for misapplication of any Cooper Bussmann product. Extensive product information is available in the Cooper Bussmann product data sheets available online at [www.cooperbussmann.com](http://www.cooperbussmann.com).

Printed in USA

©2008 Cooper Bussmann

## Magnetics Products for Power Management

### Shielded Drum Inductors and Low-Profile Shielded Drum Inductors

The Coiltronics brand has one of the largest variety of shielded drum core inductors that utilize a magnetic shield reducing EMI effects and have the best power density versus size ratio on the market.

#### Features:

- Large variety of shapes and sizes
- Maximum power density
- Ultra low-profile (as low as 1.0mm in height)
- Dual winding: coupled inductor, SEPIC, flyback transformer, 1:1 Isolation transformer
- High current
- Magnetic shielding, reduced EMI
- Compact footprint

#### Standard Product Families:

Shielded Drum: DR, DRA, DRQ, DR124, DR1030, DR1040, DR1050, LDS0705.

#### Low-Profile Shielded Drum:

SD, SDQ, SD3110, SD3112, SD3114, SD3118, SD52, SD53, SD38, SDH3812, SD6020, SD6030, SD7030, SD8328, SD8350.

### High Current Inductors

The Coiltronics high current inductor product lines provide an optimal mix of innovative packaging, high efficiency and unbeatable reliability.

#### Features:

- Large variety of shapes and sizes
- Low-profile (as low as 3mm)
- Low DCR, high efficiency
- Designed for high current, low voltage applications
- Foil construction adds higher reliability factor than traditional magnet wire used for higher frequency circuits
- Gapped ferrite: maximum efficiency, low core loss
- High temperature powder iron: 155°C maximum temperature operation, organic binder eliminates thermal aging

#### Standard Product Families:

HC1, HC2LP, HC3, HC7, HC8, HC8LP, HC9, HCP0703, HCP1104, HCP1305, HCPT1309, HCF1305, FLAT-PAC™ (FP2), FLAT-PAC™ (FP3), FLAT-PAC™ (FP4), FLAT-PAC™ (FP1308), CPL.

### Unshielded Drum Core Inductors

Coiltronics magnetics offer a wide variety of unshielded drum core inductors in different shapes and sizes to fit all board space constraints.

#### Features:

- Multiple sizes available
- Miniature surface mount design
- Low-profile
- Small footprint
- Ferrite core material

#### Standard Product Families:

UNI-PAC™ (UP1B, 2B, 3B, 4B), UNI-PAC™ 0.4C (UP0.4C), UNI-PAC™ 2.8B (UP2.8B), UNI-PAC™ 2C (UP2C), LD.

### Toroid Inductors

Coiltronics® magnetics also offer a mixture of toroid constructed inductors available in surface mount, through hole, and dual winding platforms.

#### Features:

- Surface mount and through-hole mounting
- Maximum power density
- Dual winding: coupled inductor, SEPIC, flyback transformer, 1:1 isolation transformer
- Low EMI
- Variety of core materials: powder iron, MPP, gapped ferrite, amorphous

#### Standard Product Families:

ECONO-PAC™, OCTA-PAC®, OCTA-PAC® Plus, MICRO-PAC™, MICRO-PAC™ Plus, low cost power inductors (LCPI), current sense (CS).

### Common-Mode Inductors

Coiltronics magnetics offers a variety of surface mount and through hole inductors specifically for common-mode circuits.

#### Features:

- Variety of sizes
- Surface mount and through hole packages
- Wide inductance offering
- Ferrite core material

#### Standard Product Families:

Common mode inductor SMT (CMS), common mode inductor THT (CMT)

### Transformers

Coiltronics magnetics also offers a variety of standard transformers that increase versatility in design needs.

#### Features:

- Multi-configurable transformer/inductors
- Variety of sizes
- Multi-configurable power-over-ethernet/PD flyback and forward transformers
- Cold Cathode Fluorescent Lamp (CCFL) Transformers

#### Standard Product Families:

VERSA-PAC® (VP), VERSA-PAC® high inductance (VPH), Power-over-Ethernet/PD configurable transformer (PoE) flyback and forward, Cold Cathode Fluorescent Lamp (CCFL)

### Custom Magnetics

Coiltronics magnetics can be customized to meet your application needs. We specialize in designing product to specific requirements and new technology, as well as modifying our standard product platforms to meet your requirements.

Modifications to standard products are available.

All surface mount components are available in tape-and-reel packaging for pick-and-place utilization.

FLAT-PAC™ Series

HCP Series

Solder Profile

Application Notes  
- Core Power

Application Notes  
- High Temp.

Application Notes  
- Switching

## FLAT-PAC™ FP0705 Series



### Description

- Halogen free
- 125°C maximum total temperature operation
- 7.0 x 7.0 x 4.95mm surface mount package
- Ferrite core material, high current carrying capacity
- Low core losses
- Controlled DCR tolerance for sensing circuits
- Inductance range from 72nH to 220nH
- Current range from 20 to 65 amps, frequency range up to 2MHz
- RoHS compliant

### Applications

- Portable electronics
- Servers and workstations
- Data networking and storage systems
- Notebook and desktop computers
- Graphics cards and battery power systems
- Multi-phase regulators
- Voltage Regulator Module (VRM)
- DCR sensing

RoHS  
2002/95/EC

### Environmental Data

- Storage temperature range: -40°C to +125°C
- Operating temperature range: -40°C to +125°C (Range is application specific)
- Solder reflow temperature: J-STD-020D compliant

### Packaging

- Supplied in tape-and-reel packaging, 950 parts per reel, 13" diameter reel

### Product Specifications

Part Number	OCL <sup>1</sup> ± 10% (nH)	FLL <sup>2</sup> Min. (nH)	I <sub>rms</sub> <sup>3</sup> (Amps)	I <sub>sat</sub> <sup>1,4</sup> @ 25°C (Amps)	I <sub>sat</sub> <sup>2,5</sup> @ 125°C (Amps)	DCR (mΩ) @ 20°C	K-factor <sup>6</sup>
<b>R1 Version</b>							
FP0705R1-R07-R	72	51	43	65	50	0.25 ± 10%	826
FP0705R1-R10-R	105	75		44	36		826
FP0705R1-R12-R	120	86		37	30		826
FP0705R1-R15-R	150	108		30	24		826
FP0705R1-R18-R	180	130		25	20		826
FP0705R1-R22-R	220	158		20	16		826
<b>R2 Version</b>							
FP0705R2-R07-R	72	51	38	65	50	0.32 ± 9.4%	826
FP0705R2-R10-R	105	75		44	36		826
FP0705R2-R12-R	120	86		37	30		826
FP0705R2-R15-R	150	108		30	24		826
FP0705R2-R18-R	180	130		25	20		826
FP0705R2-R22-R	220	158		20	16		826
<b>R3 Version</b>							
FP0705R3-R07-R	72	51	32	65	50	0.46 ± 6.5%	826
FP0705R3-R10-R	105	75		44	36		826
FP0705R3-R12-R	120	86		37	30		826
FP0705R3-R15-R	150	108		30	24		826
FP0705R3-R18-R	180	130		25	20		826
FP0705R3-R22-R	220	158		20	16		826

1 Open Circuit Inductance (OCL) Test Parameters: 100kHz, 0.10V<sub>rms</sub>, 0.0Adc

2 Full Load Inductance (FLL) Test Parameters: 100kHz, 0.1V<sub>rms</sub>, I<sub>sat</sub><sup>1</sup>

3 I<sub>rms</sub>: DC current for an approximate temperature rise of 40°C without core loss. Derating is necessary for AC currents. PCB pad layout, trace thickness and width, air-flow and proximity of other heat generating components will affect the temperature rise. It is recommended the part temperature not exceed 125°C under worst case operating conditions verified in the end application.

4 I<sub>sat</sub><sup>1</sup>: Peak current for approximately 20% rolloff at +25°C.

5 I<sub>sat</sub><sup>2</sup>: Peak current for approximately 20% rolloff at +125°C.

6 K-factor: Used to determine B<sub>p-p</sub> for core loss (see graph). B<sub>p-p</sub> = K \* L \* ΔI \* 10<sup>-3</sup>, B<sub>p-p</sub>: (Gauss), K: (K-factor from table), L: (inductance in nH), ΔI (peak-to-peak ripple current in amps).

7 Part Number Definition: FP0705Rx-Rxx-R

• FP0705 = Product code and size

• Rxx= Inductance value in μH, R = decimal point

• Rx is the DCR indicator

• "-R" suffix = RoHS compliant

## FLAT-PAC™ FP0705 Series

**Dimensions - mm**    A = 7.0 Max.    B = 7.0 Max.    C = 4.95 Max.    D = 2.45 ± 0.2    E = 1.52 ± 0.2    F = 3.5 Typ.

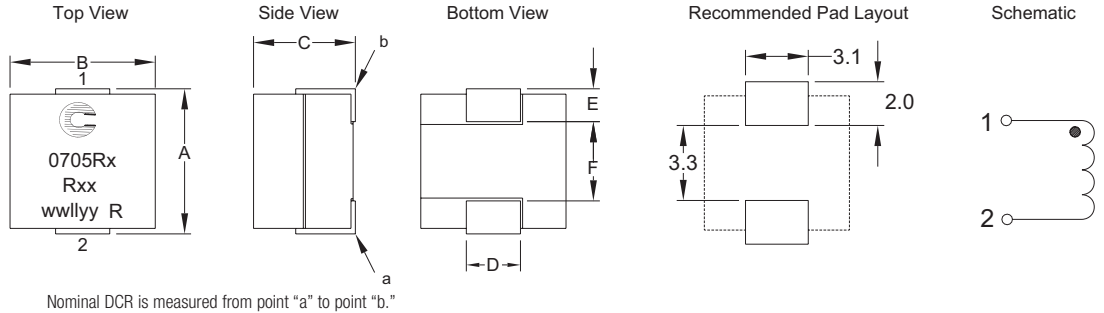

Part Marking: Coiltronics Logo    0705Rx (Rx = DCR indicator)    Rxx = inductance value in  $\mu\text{H}$  (R = decimal point)    wwllly = date code    R = revision level

## Packaging Information - mm

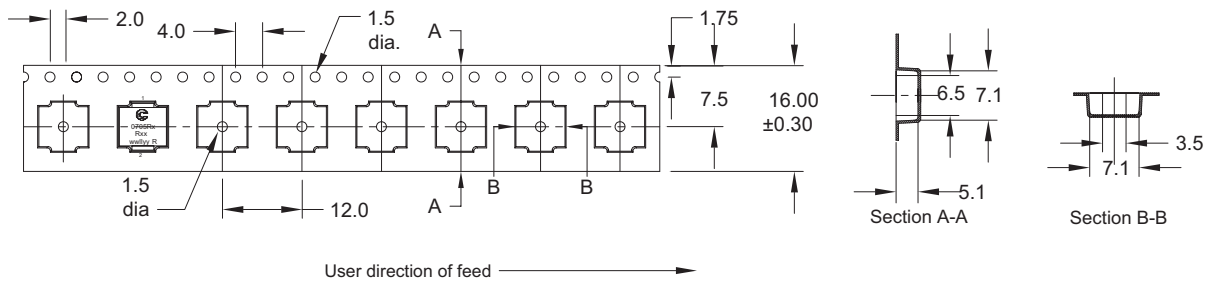

Supplied in tape-and-reel packaging, 950 parts per reel, 13" diameter reel.

## Temperature Rise vs. Total Loss

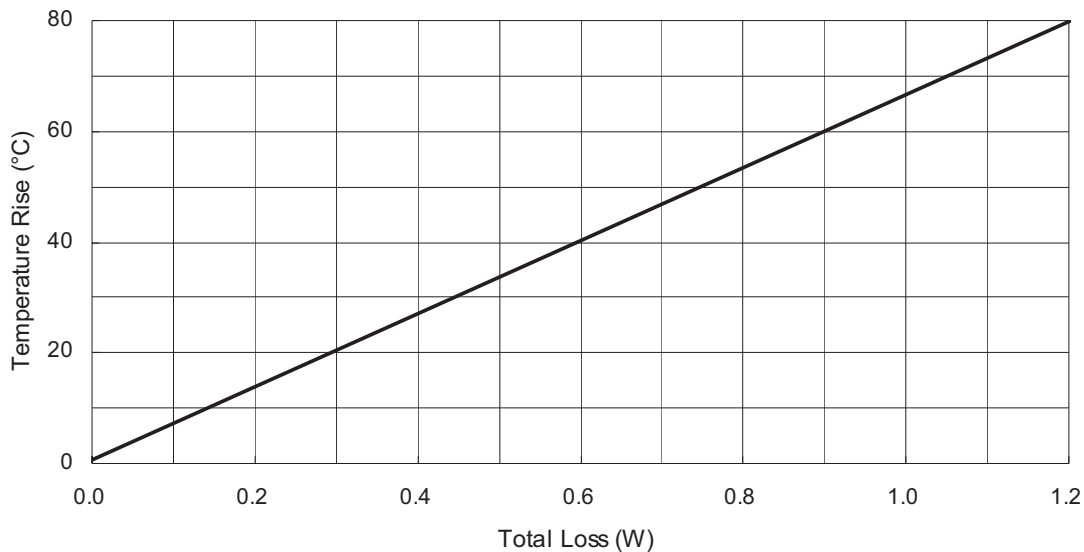

## FLAT-PAC™ FP0705 Series

### Inductance Characteristics

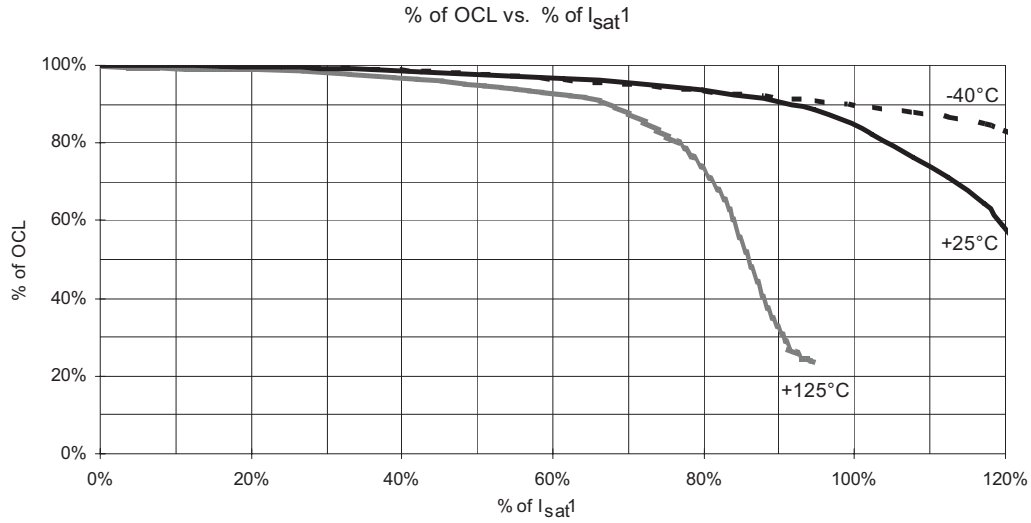

### Core Loss

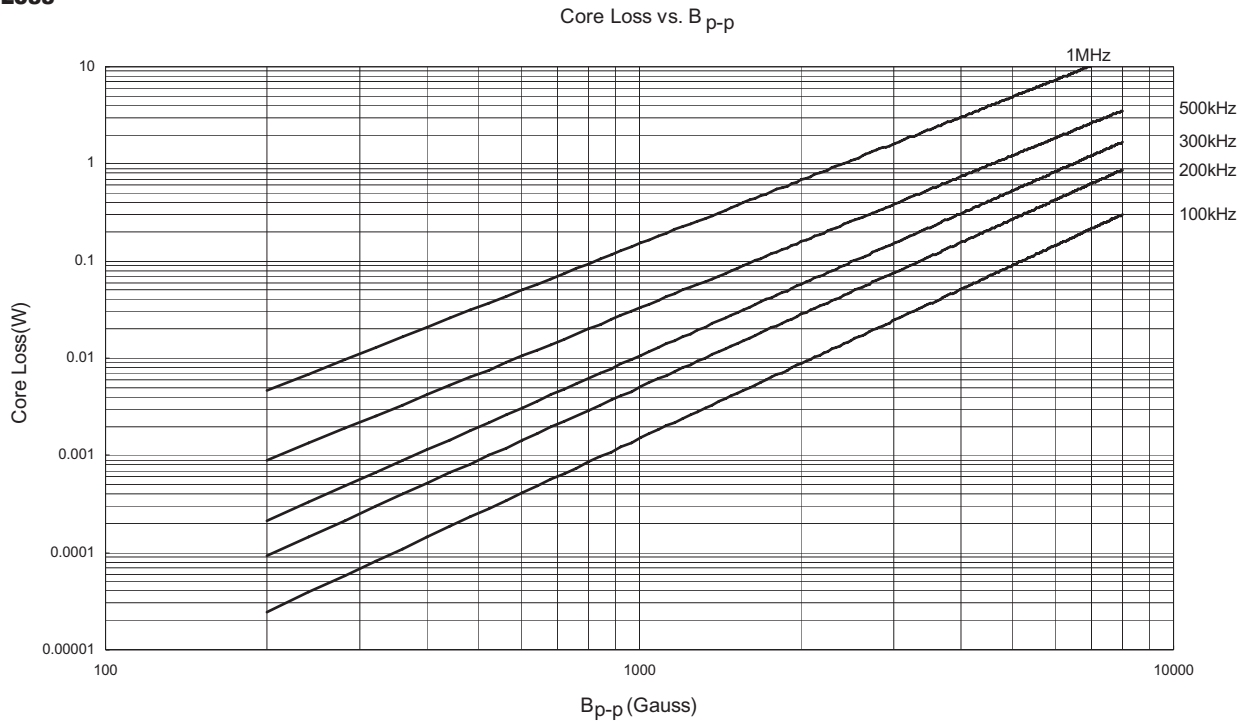

## FLAT-PAC™ FP0708 Series



SMD Device

### Description

- Halogen free
- 125°C maximum total temperature operation
- 8.5 x 7.0 x 7.2mm surface mount package
- Ferrite core material
- High current carrying capacity
- Low core losses
- Controlled DCR tolerance for sensing circuits
- Inductance range from 72nH to 190nH
- Current range from 37 to 90 amps
- Frequency range up to 2MHz
- RoHS compliant

### Applications

- Multi-phase regulators
- Voltage Regulator Module (VRM)
- Point of load modules
- Servers and workstations
- Data networking and storage systems
- Notebook and desktop computers
- Graphics cards and battery power systems
- DCR sensing



### Environmental Data

- Storage temperature range: -40°C to +125°C
- Operating temperature range: -40°C to +125°C (Range is application specific)
- Solder reflow temperature: J-STD-020D compliant

### Packaging

- Supplied in tape-and-reel packaging, 640 parts per reel, 13" diameter reel

Product Specifications							
Part Number	OCL <sup>1</sup> ± 10% (nH)	FLL <sup>2</sup> Min. (nH)	I <sub>rms</sub> <sup>3</sup> (Amps)	I <sub>sat</sub> <sup>4</sup> @ 25°C (Amps)	I <sub>sat</sub> <sup>5</sup> @ 125°C (Amps)	DCR (mΩ) @ 20°C	K-factor <sup>6</sup>
FP0708R1-R07-R	72	52	44	90	72	0.35 ± 8.6%	557
FP0708R1-R09-R	90	64		75	60		557
FP0708R1-R10-R	105	75		68	54		557
FP0708R1-R12-R	120	86		59	47		557
FP0708R1-R15-R	150	108		47	37		557
FP0708R1-R20-R	190	1.5		37	29		557

1 Open Circuit Inductance (OCL) Test Parameters: 100kHz, 0.10V<sub>rms</sub>, 0.0Adc

2 Full Load Inductance (FLL) Test Parameters: 100kHz, 0.1V<sub>rms</sub>, I<sub>sat</sub><sup>1</sup>

3 I<sub>rms</sub>: DC current for an approximate temperature rise of 40°C without core loss. Derating is necessary for AC currents. PCB pad layout, trace thickness and width, air-flow and proximity of other heat generating components will affect the temperature rise. It is recommended the part temperature not exceed 125°C under worst case operating conditions verified in the end application.

4 I<sub>sat</sub><sup>1</sup>: Peak current for approximately 20% rolloff at +25°C.

5 I<sub>sat</sub><sup>2</sup>: Peak current for approximately 20% rolloff at +125°C.

6 K-factor: Used to determine B<sub>p-p</sub> for core loss (see graph). B<sub>p-p</sub> = K · L · ΔI · 10<sup>-3</sup>, B<sub>p-p</sub>: (Gauss), K: (K-factor from table), L: (inductance in nH), ΔI (peak-to-peak ripple current in amps).

7 Part Number Definition: FP0705Rx-Rxx-R

• FP0708 = Product code and size

• Rxx= Inductance value in μH, R = decimal point

• Rx is the DCR indicator

• "-R" suffix = RoHS compliant

## FLAT-PAC™ FP0708 Series

**Dimensions - mm**    A = 7.0 Max.    B = 8.5 Max.    C = 7.2 Max.    D = 2.1 ± 0.15    E = 1.52 ± 0.2    F = 3.6 Typ.

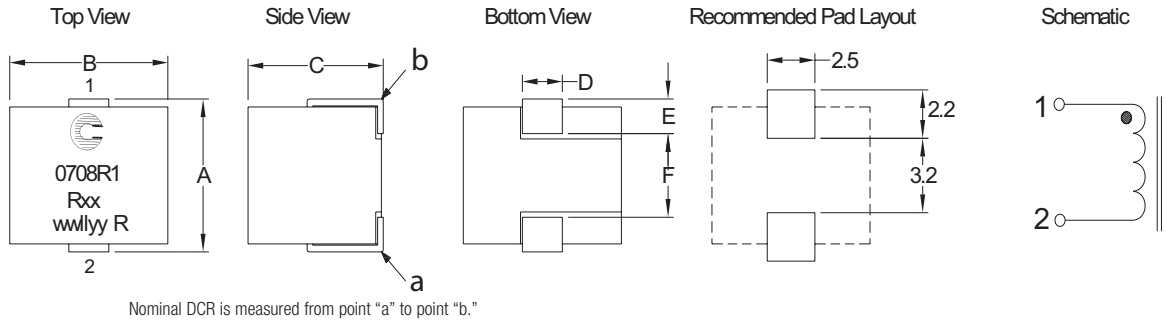

Part Marking: Coiltronics Logo    0705Rx (Rx = DCR indicator)    Rxx = inductance value in  $\mu\text{H}$  (R = decimal point)    wwllly = date code    R = revision level

## Packaging Information - mm

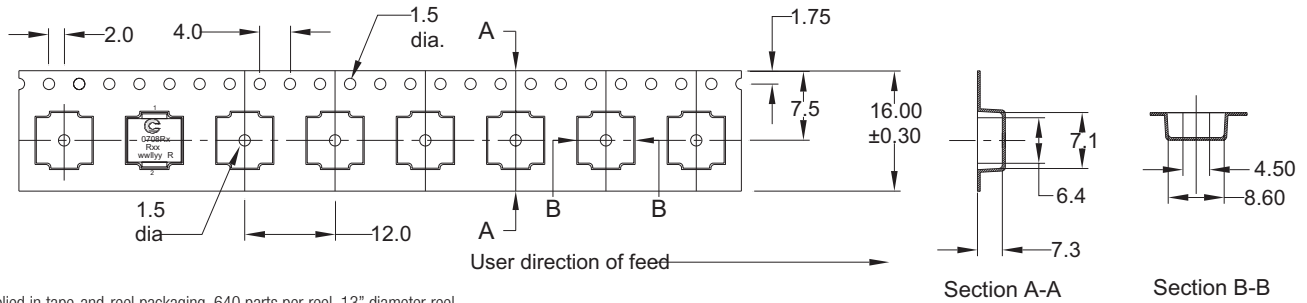

Supplied in tape-and-reel packaging, 640 parts per reel, 13" diameter reel.

## Temperature Rise vs. Total Loss

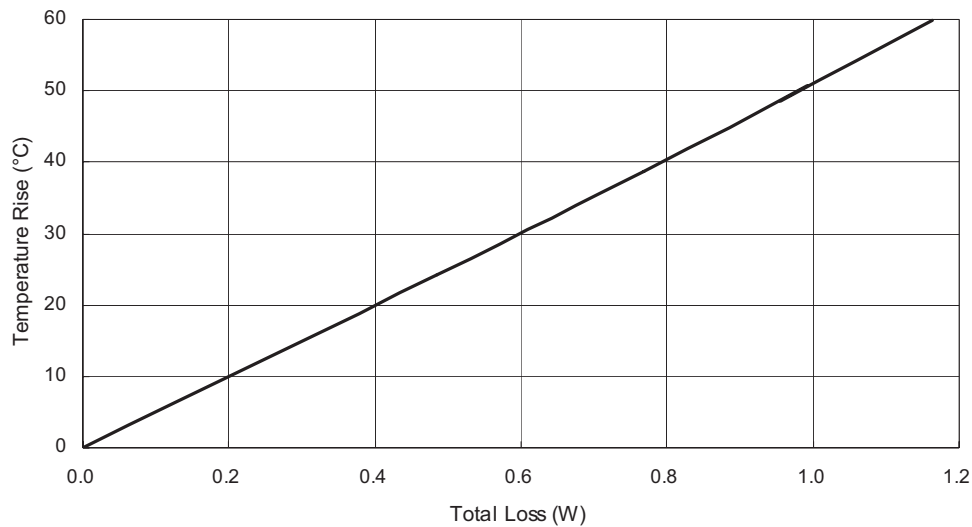



FLAT-PAC™ FP0708 Series

Inductance Characteristics

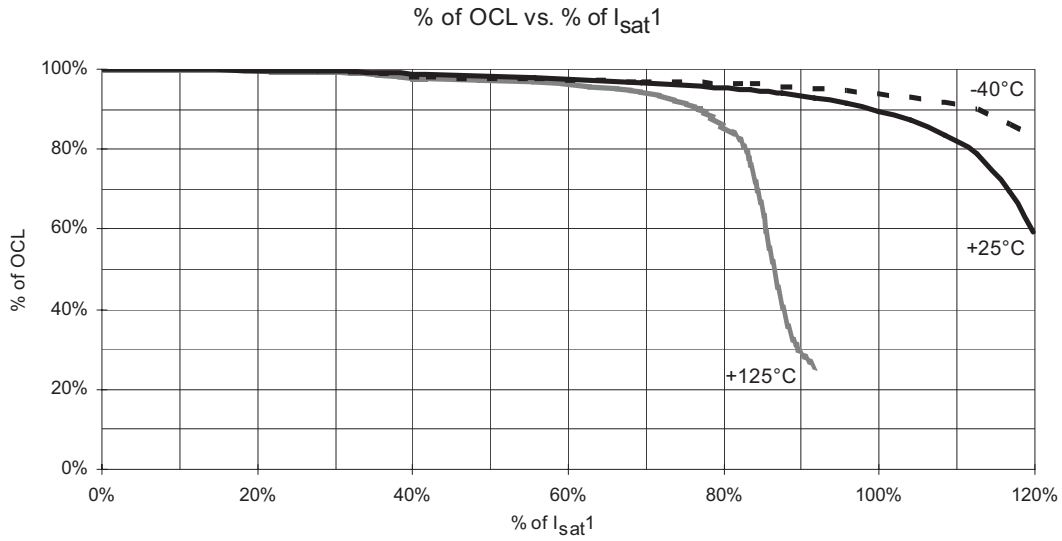

Core Loss

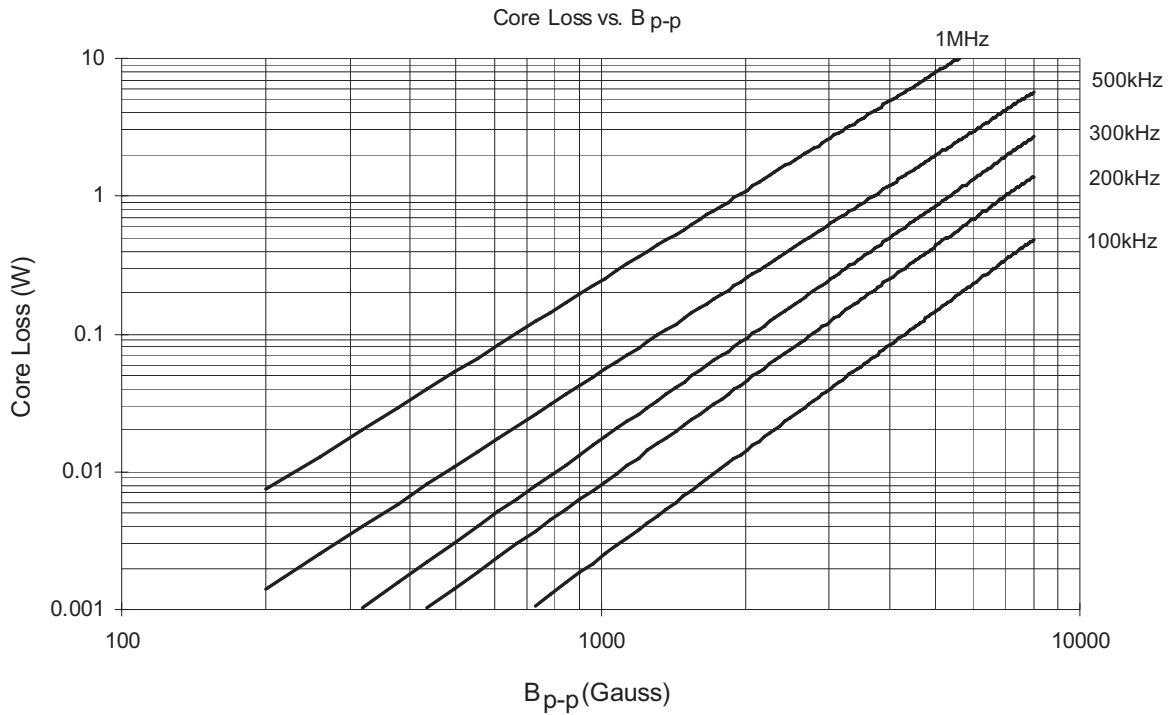

FLAT-PAC™ Series

## FLAT-PAC™ FP0805 Series

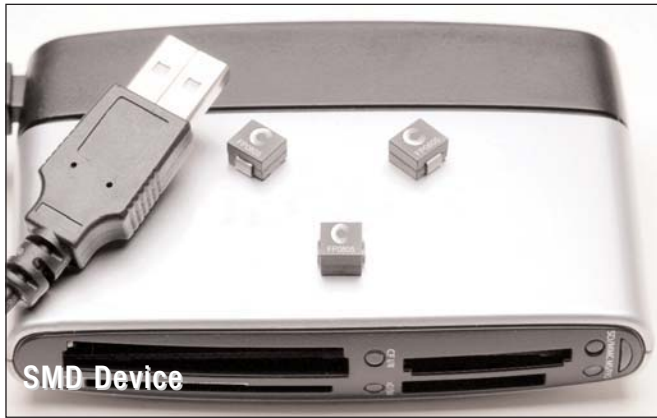

### Description

- Halogen free
- 125°C maximum total temperature operation
- 7.5 x 7.6 x 5mm surface mount package
- Ferrite core material
- High current carrying capacity, low core losses
- Controlled DCR tolerance for sensing circuits
- Inductance range from 32nH to 200nH
- Current range from 20 to 110 amps
- Frequency range up to 2MHz
- RoHS compliant

### Applications

- Multi-phase regulators
- Voltage Regulator Module (VRM)
- Point-of-load modules
- Desktop and server VRMs and EVRDs
- Data networking and storage systems
- Notebook regulators
- Graphics cards and battery power systems
- DCR sensing

RoHS  
2002/95/EC

### Environmental Data

- Storage temperature range: -40°C to +125°C
- Operating temperature range: -40°C to +125°C  
(Range is application specific)
- Solder reflow temperature: J-STD-020D compliant

### Packaging

- Supplied in tape-and-reel packaging, 950 parts per reel, 13" diameter reel

Product Specifications							
Part Number <sup>7</sup>	OCL <sup>1</sup> ± 10% (nH)	FLL <sup>2</sup> Min. (nH)	I <sub>rms</sub> <sup>3</sup> (Amps)	I <sub>sat</sub> <sup>14</sup> @ 25°C (Amps)	I <sub>sat</sub> <sup>25</sup> @ 125°C (Amps)	DCR (mΩ) @ 20°C	K-factor <sup>6</sup>
FP0805R1-R03-R	32	23	65	110	95	0.17 ± 17%	823.6
FP0805R1-R06-R	58	42		83	61		823.6
FP0805R1-R07-R	72	52		67	49		823.6
FP0805R1-R10-R	100	72		50	35		823.6
FP0805R1-R20-R	200	144		20	16		823.6

1 Open Circuit Inductance (OCL) Test Parameters: 100kHz, 0.10V<sub>rms</sub>, 0.0Adc

2 Full Load Inductance (FLL) Test Parameters: 100kHz, 0.1V<sub>rms</sub>, I<sub>sat</sub><sup>1</sup>

3 I<sub>rms</sub>: DC current for an approximate temperature rise of 40°C without core loss. Derating is necessary for AC currents. PCB pad layout, trace thickness and width, air-flow and proximity of other heat generating components will affect the temperature rise. It is recommended the part temperature not exceed 125°C under worst case operating conditions verified in the end application.

4 I<sub>sat</sub><sup>1</sup>: Peak current for approximately 20% rolloff at +25°C.

5 I<sub>sat</sub><sup>2</sup>: Peak current for approximately 20% rolloff at +125°C.

6 K-factor: Used to determine B<sub>p-p</sub> for core loss (see graph). B<sub>p-p</sub> = K \* L \* ΔI \* 10<sup>-3</sup>, B<sub>p-p</sub>: (Gauss), K: (K-factor from table), L: (inductance in nH), ΔI (peak-to-peak ripple current in amps).

7 Part Number Definition: FP0805Rx-Rxx-R

• FP0805 = Product code and size

• Rxx= Inductance value in μH, R = decimal point

• Rx is the DCR indicator

• "-R" suffix = RoHS compliant

FLAT-PAC™ FP0805 Series

Dimensions - mm

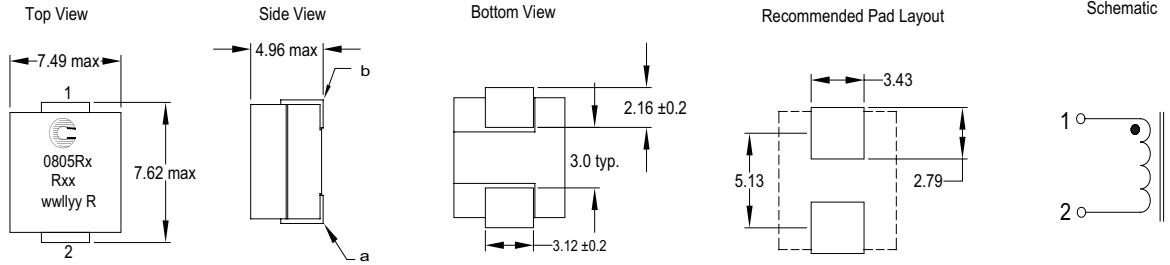

The nominal DCR is measured from point "a" to point "b."

Part Marking: Coiltronics Logo    0805Rx (Rx = DCR Indicator)    Rxx = Inductance value in  $\mu\text{H}$ . (R = Decimal point)    wwllyy = Date code    R = Revision level

Packaging Information - mm

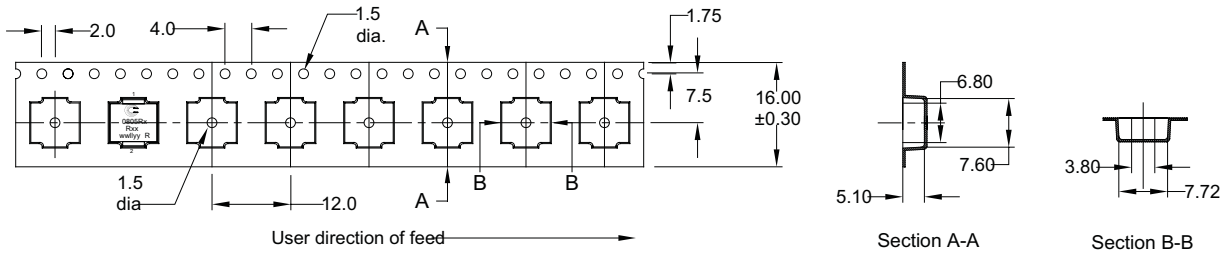

Supplied in tape-and-reel packaging, 950 parts per reel, 13" diameter reel.

Temperature Rise vs. Total Loss

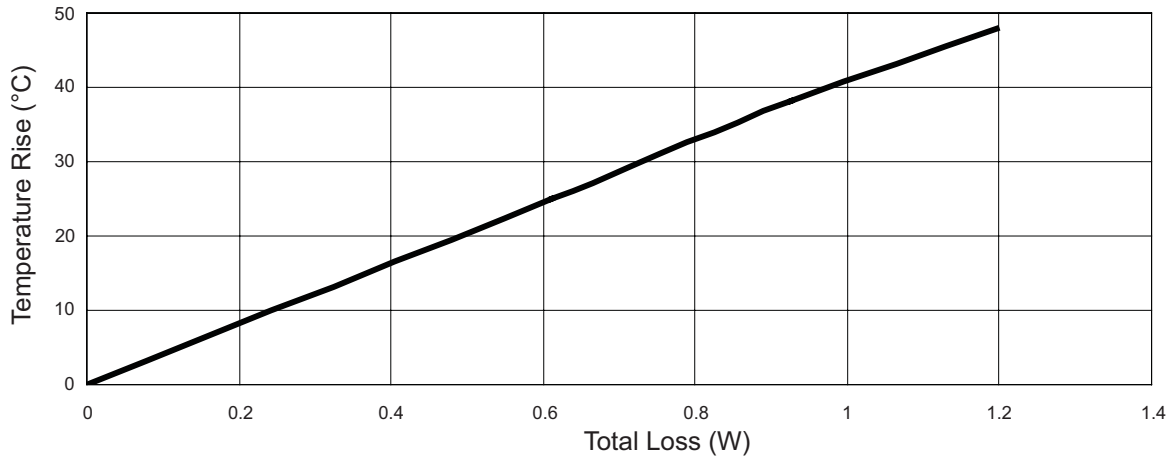

FLAT-PAC™ FP0805 Series

Core Loss

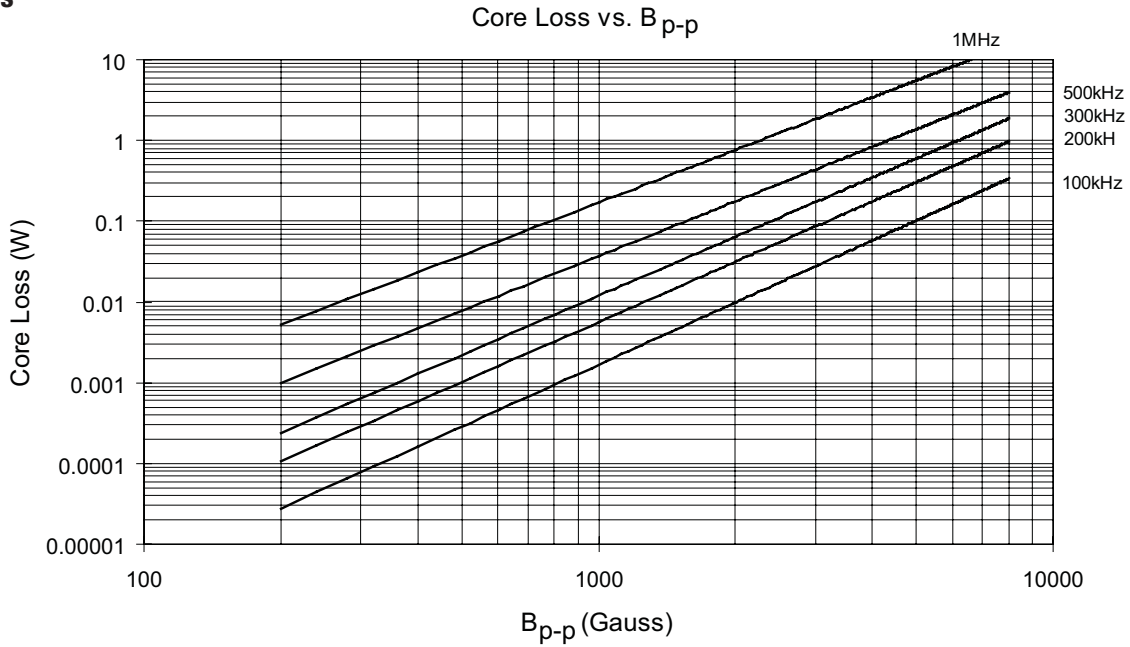

Inductance Characteristics

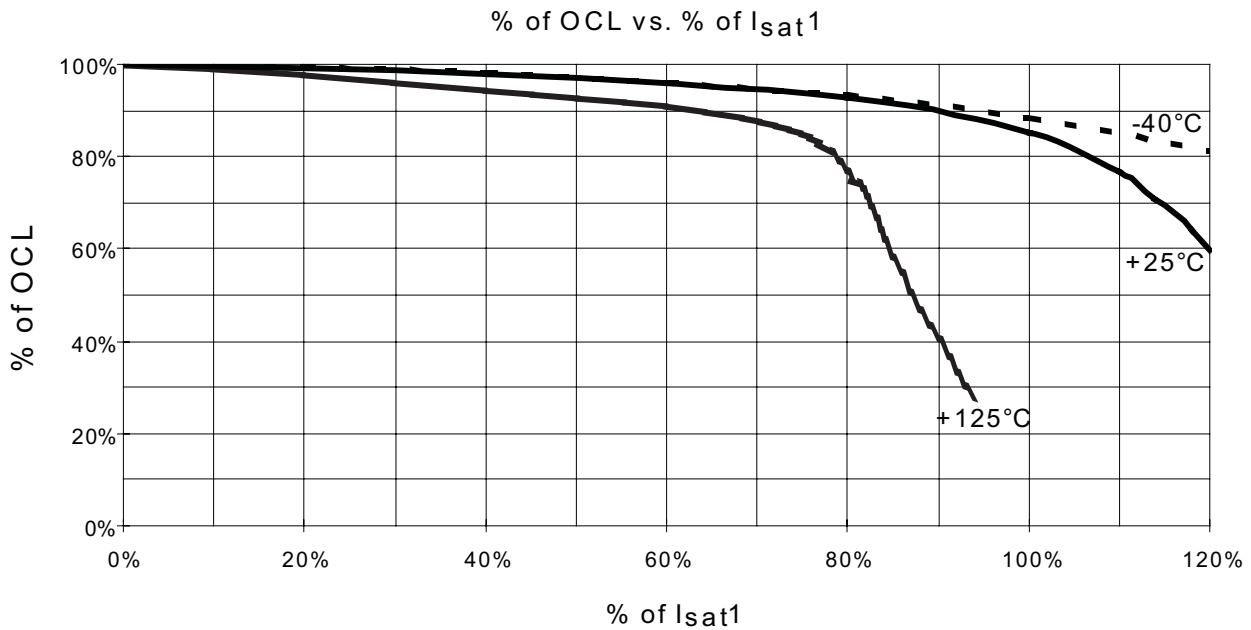

## FLAT-PAC™ FP0807 Series



**SMD Device**

### Description:

- Halogen free
- 125°C maximum total temperature operation
- 7.4 x 7.6 x 7.0mm surface mount package
- Ferrite core material
- High current carrying capacity, low core losses
- Controlled DCR tolerance for sensing circuits
- Inductance range from 70nH to 220nH
- Current range from 35 amps to 108 amps
- Frequency range up to 2MHz
- RoHS compliant

### Applications:

- Multi-phase regulators
- Voltage Regulator Module (VRM)
- Desktop and server VRMs and EVRDs
- Notebook regulators
- Data networking and storage systems
- Graphics cards and battery power systems
- Point-of-load modules
- DCR sensing



### Environmental Data:

- Storage temperature range: -40°C to +125°C
- Operating temperature range: -40°C to +125°C (Range is application specific)
- Solder reflow temperature: J-STD-020D compliant

### Packaging:

- Supplied in tape-and-reel packaging, 600 parts per reel, 13" diameter reel

FLAT-PAC™ Series

### Product Specifications

Part Number <sup>7</sup>	OCL <sup>1</sup> ± 10% (nH)	FLL <sup>2</sup> Min. (nH)	I <sub>rms</sub> <sup>3</sup> (Amps)	I <sub>sat</sub> <sup>14</sup> @ 25°C (Amps)	I <sub>sat</sub> <sup>25</sup> @ 125°C (Amps)	DCR (mΩ) @ 20°C	K-factor <sup>6</sup>
FP0807R1-R07-R	70	50	49	108	79	0.50 ± 6%	520
FP0807R1-R10-R	100	72		77	55		520
FP0807R1-R12-R	120	86		66	48		520
FP0807R1-R16-R	160	115		48	36		520
FP0807R1-R18-R	180	129		42	32		520
FP0807R1-R20-R	200	144		38	28		520
FP0807R1-R22-R	220	158		35	25		520

1 Open Circuit Inductance (OCL) Test Parameters: 100kHz, 0.10V<sub>rms</sub>, 0.0Adc

2 Full Load Inductance (FLL) Test Parameters: 100kHz, 0.1V<sub>rms</sub>, I<sub>sat</sub><sup>1</sup>

3 I<sub>rms</sub>: DC current for an approximate temperature rise of 40°C without core loss. Derating is necessary for AC currents. PCB pad layout, trace thickness and width, air-flow and proximity of other heat generating components will affect the temperature rise. It is recommended the part temperature not exceed 125°C under worst case operating conditions verified in the end application.

4 I<sub>sat</sub><sup>1</sup>: Peak current for approximately 20% rolloff at +25°C.

5 I<sub>sat</sub><sup>2</sup>: Peak current for approximately 20% rolloff at +125°C.

6 K-factor: Used to determine B<sub>p-p</sub> for core loss (see graph). B<sub>p-p</sub> = K \* L \* ΔI \* 10<sup>-3</sup>, B<sub>p-p</sub>: (Gauss),

K: (K-factor from table), L: (inductance in nH), ΔI (peak-to-peak ripple current in amps).

7 Part Number Definition: FP0807Rx-Rxx-R

• FP0807 = Product code and size

• Rxx= Inductance value in μH, R = decimal point

• Rx is the DCR indicator

• "-R" suffix = RoHS compliant

## FLAT-PAC™ FP0807 Series

### Dimensions - mm

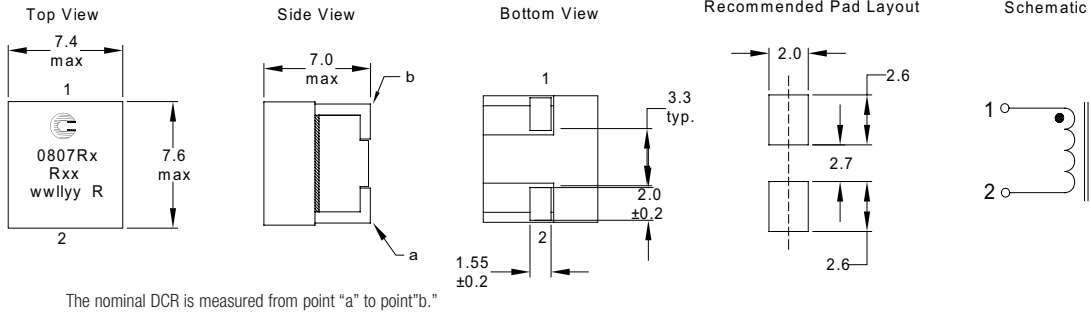

Part Marking: Coiltronics Logo    0807Rx (Rx = DCR Indicator)    Rxx = Inductance value in  $\mu\text{H}$ . (R = Decimal point)    wwllly = Date code    R = Revision level

### Packaging Information - mm

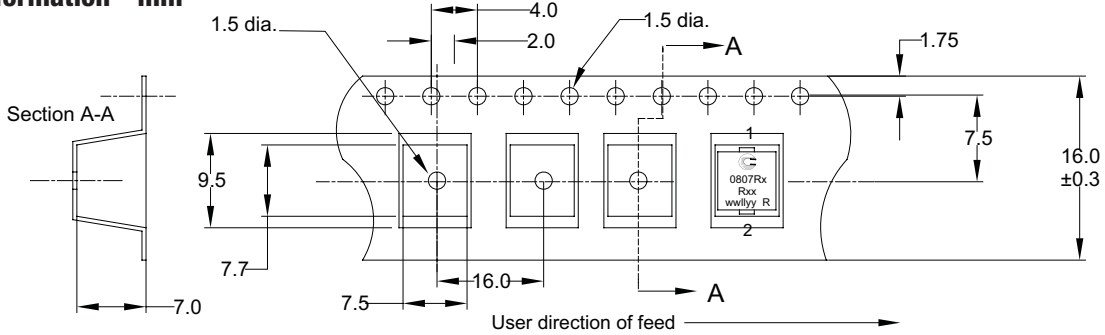

Supplied in tape-and-reel packaging, 600 parts per reel, 13" diameter reel.

### Temperature Rise vs. Total Loss

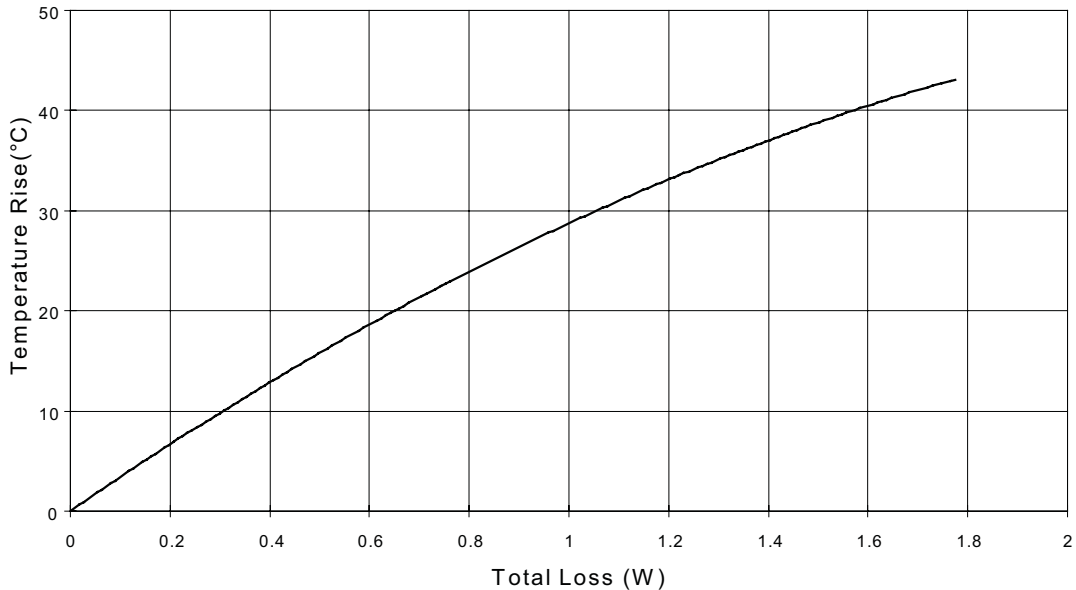

**FLAT-PAC™ FP0807 Series**

**Core Loss**

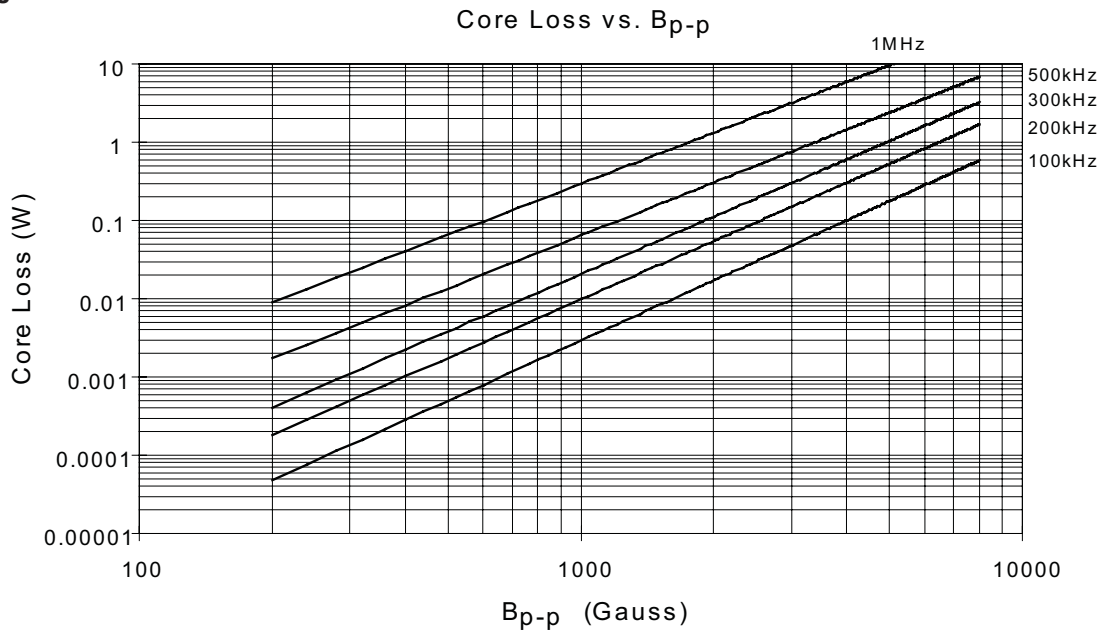

FLAT-PAC™ Series

**Inductance Characteristics**

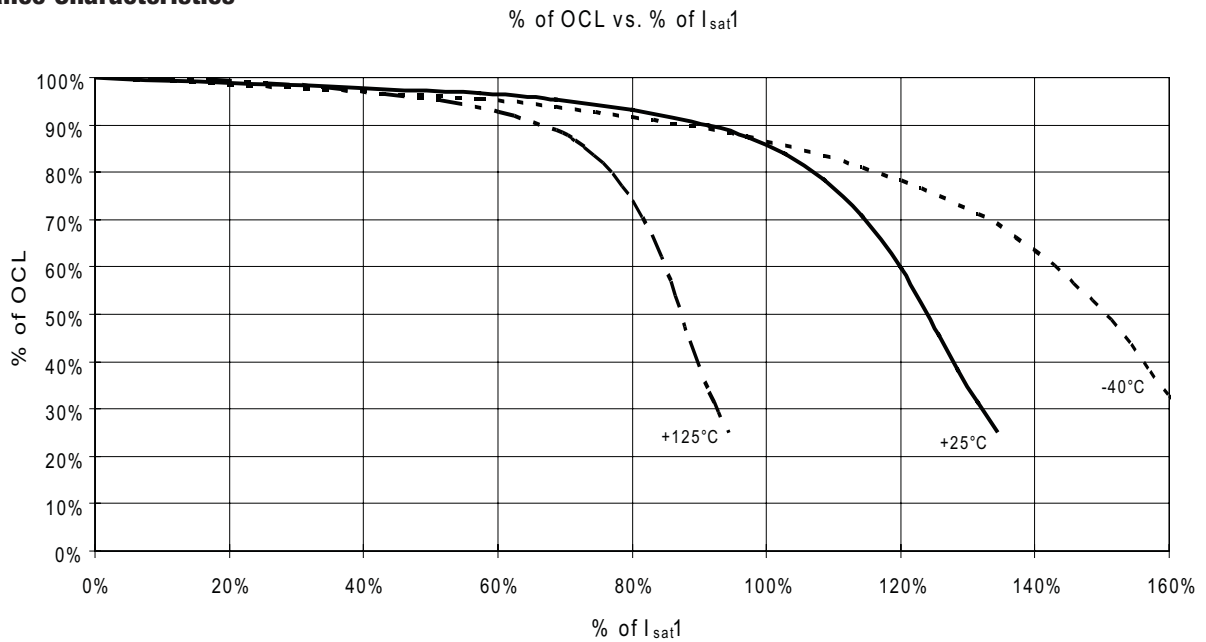

## FLAT-PAC™ FP1005 Series



### Description

- Halogen free
- 125°C maximum total temperature operation
- 10.2 x 7.0 x 4.95mm surface mount package
- Ferrite core material
- High current carrying capacity, low core losses
- Controlled DCR tolerance for sensing circuits
- Inductance range from 85nH to 220nH
- Current range from 33 to 90 amps
- Frequency range up to 2MHz
- RoHS compliant

### Applications

- Multi-phase regulators
- Voltage Regulator Module (VRM)
- Point-of-load modules
- Desktop and server VRMs and EVRDs
- Data networking and storage systems
- Notebook regulators
- Graphics cards and battery power systems
- DCR sensing

RoHS  
2002/95/EC

### Environmental Data

- Storage temperature range: -40°C to +125°C
- Operating temperature range: -40°C to +125°C  
(Range is application specific)
- Solder reflow temperature: J-STD-020D compliant

### Packaging

- Supplied in tape-and-reel packaging, 950 parts per reel, 13" diameter reel

### Product Specifications

Part Number <sup>7</sup>	OCL <sup>1</sup> ± 10% (nH)	FLL <sup>2</sup> Min. (nH)	I <sub>rms</sub> <sup>3</sup> (Amps)	I <sub>sat</sub> <sup>14</sup> @ 25°C (Amps)	I <sub>sat</sub> <sup>25</sup> @ 125°C (Amps)	DCR (mΩ) @ 20°C	K-factor <sup>6</sup>
R1 Version							
FP1005R1-R08-R	85	61	53	90	64	0.39 ± 7.7%	536
FP1005R1-R10-R	100	72		73	57		536
FP1005R1-R12-R	120	86		60	48		536
FP1005R1-R15-R	150	108		47	37		536
FP1005R1-R22-R	220	158		33	26		536
R2 Version							
FP1005R2-R08-R	85	61	50	90	64	0.47 ± 6.7%	536
FP1005R2-R10-R	100	72		73	57		536
FP1005R2-R12-R	120	86		60	48		536
FP1005R2-R15-R	150	108		47	37		536
FP1005R2-R22-R	220	158		33	26		536
R3 Version							
FP1005R3-R08-R	85	61	45	90	64	0.55 ± 5.4%	536
FP1005R3-R10-R	100	72		73	57		536
FP1005R3-R12-R	120	86		60	48		536
FP1005R3-R15-R	150	108		47	37		536
FP1005R3-R22-R	220	158		33	26		536

1 Open Circuit Inductance (OCL) Test Parameters: 100kHz, 0.10V<sub>rms</sub>, 0.0A<sub>dc</sub>

2 Full Load Inductance (FLL) Test Parameters: 100kHz, 0.1V<sub>rms</sub>, I<sub>sat</sub><sup>1</sup>

3 I<sub>rms</sub>: DC current for an approximate temperature rise of 40°C without core loss. Derating is necessary for AC currents. PCB pad layout, trace thickness and width, air-flow and proximity of other heat-generating components will affect the temperature rise. It is recommended the part temperature not exceed 125°C under worst case operating conditions verified in the end application.

4 I<sub>sat</sub><sup>1</sup>: Peak current for approximately 20% rolloff at +25°C.

5 I<sub>sat</sub><sup>2</sup>: Peak current for approximately 20% rolloff at +125°C.

6 K-factor: Used to determine B<sub>p-p</sub> for core loss (see graph). B<sub>p-p</sub> = K \* L \* ΔI \* 10<sup>-3</sup>, B<sub>p-p</sub>: (Gauss), K: (K-factor from table), L: (inductance in nH), ΔI (peak-to-peak ripple current in amps).

7 Part Number Definition: FP1005Rx-Rxx-R

• FP1005 = Product code and size

• Rxx= Inductance value in μH, R = decimal point

• Rx is the DCR indicator

• "-R" suffix = RoHS compliant



FLAT-PAC™ FP1005 Series

Dimensions - mm

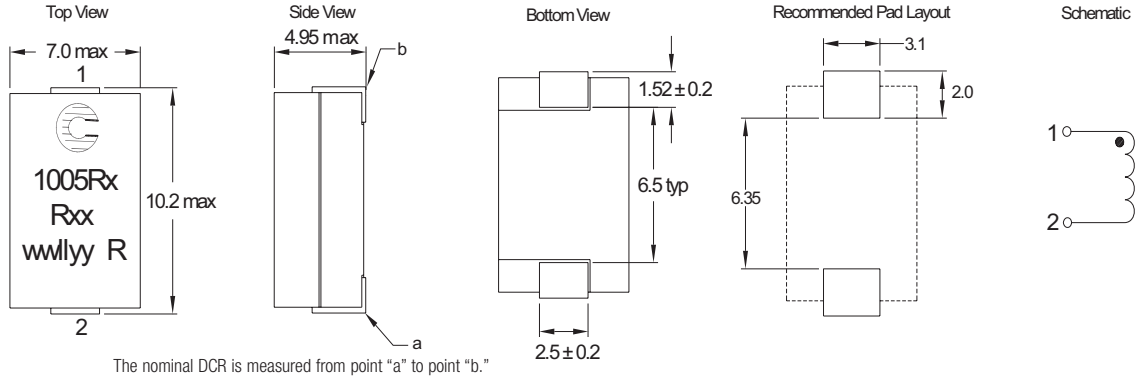

Part Marking: Coiltronics Logo    1005Rx (Rx = DCR indicator)    Rxx = Inductance value in  $\mu\text{H}$  (R = Decimal point)    wwlyy = Date code    R = Revision level

Packaging Information - mm

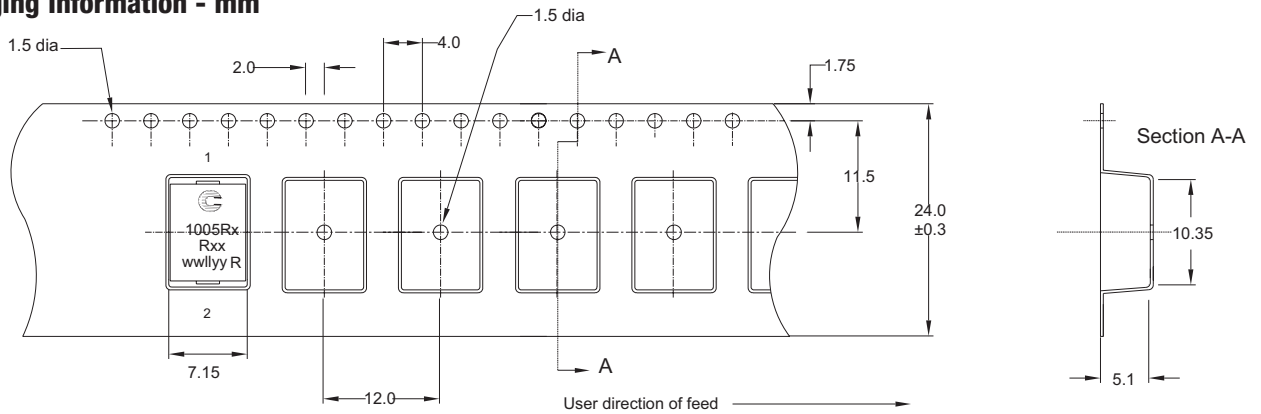

Supplied in tape-and-reel packaging, 950 parts per reel, 13" diameter reel.

Temperature Rise vs. Total Loss

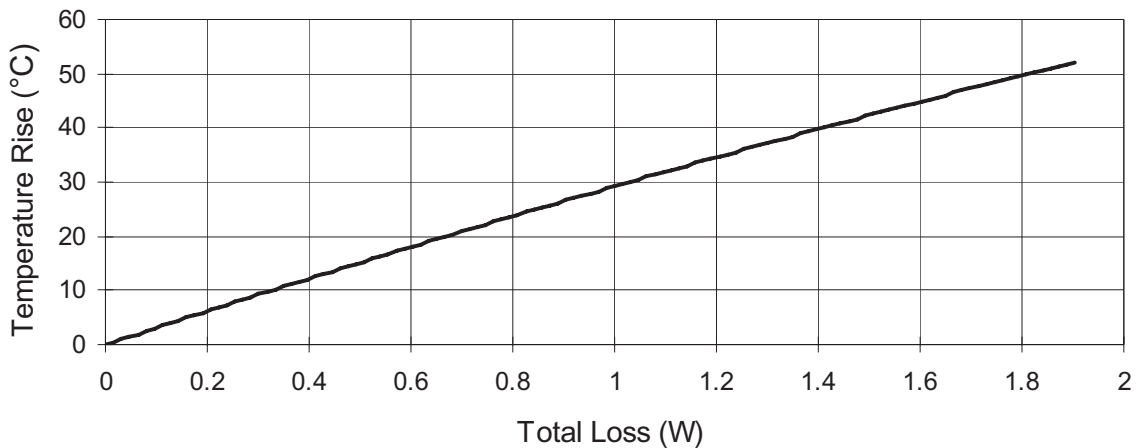

## FLAT-PAC™ FP1005 Series

### Core Loss

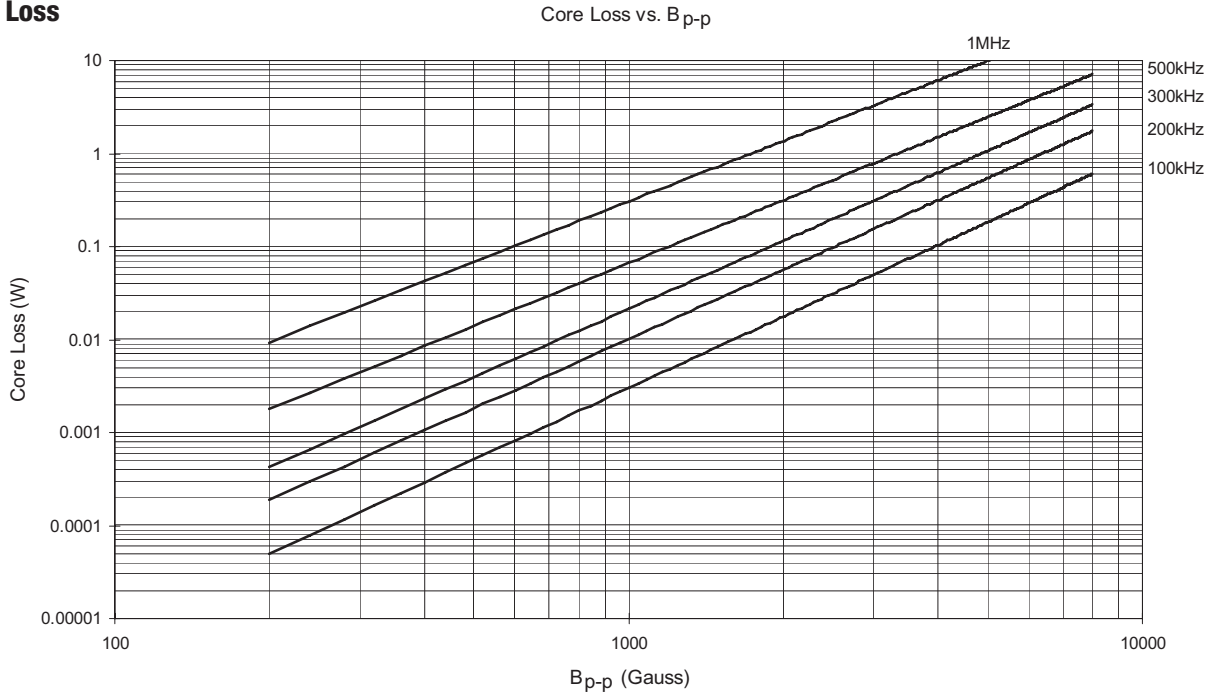

### Inductance Characteristics

% of OCL vs. % of  $I_{sat1}$

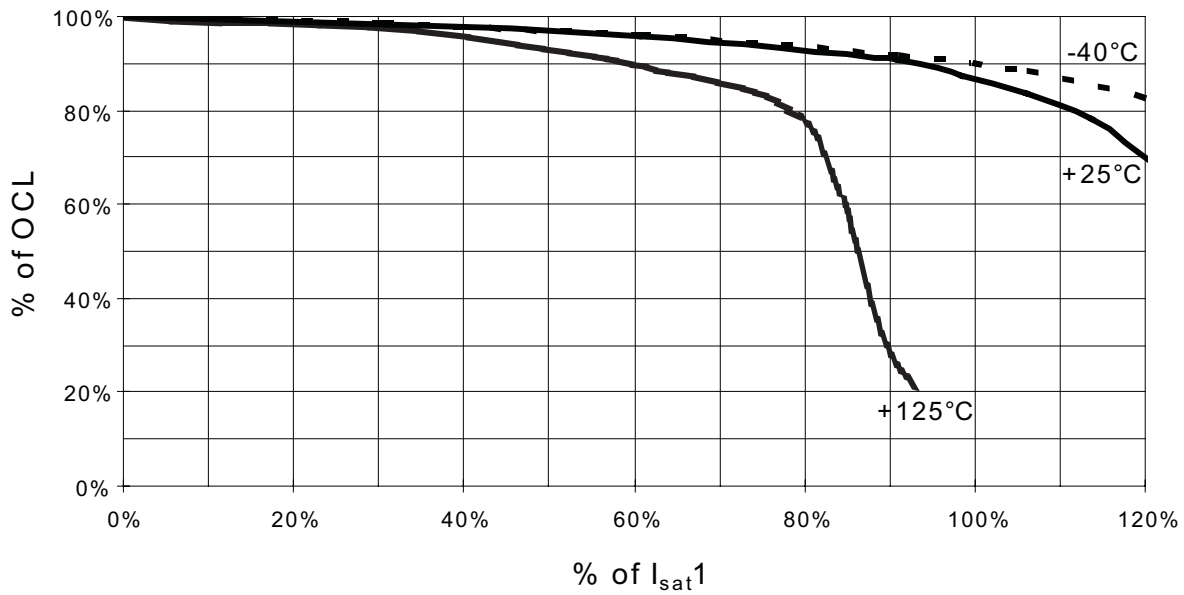

## FLAT-PAC™ FP1006 Series



### Description

- Halogen free
- 125°C maximum total temperature operation
- 10.2 x 8.0 x 6.0mm surface mount package
- Ferrite core material
- High current carrying capacity, low core losses
- Controlled DCR tolerance for sensing circuits
- Inductance range from 85nH to 220nH
- Current range from 38 to 100 amps
- Frequency range up to 2MHz
- RoHS compliant

### Applications

- Multi-phase regulators
- Voltage Regulator Module (VRM)
- Point-of-load modules
- Desktop and server VRMs and EVRDs
- Data networking and storage systems
- Notebook regulators
- Graphics cards and battery power systems
- DCR sensing

### Environmental Data

- Storage temperature range: -40°C to +125°C
- Operating temperature range: -40°C to +125°C (Range is application specific)
- Solder reflow temperature: J-STD-020D compliant

### Packaging

- Supplied in tape-and-reel packaging, 850 parts per reel, 13" diameter reel

Product Specifications							
Part Number <sup>7</sup>	OCL <sup>1</sup> ± 10% (nH)	FLL <sup>2</sup> Min. (nH)	I <sub>rms</sub> <sup>3</sup> (Amps)	I <sub>sat</sub> <sup>14</sup> @ 25°C (Amps)	I <sub>sat</sub> <sup>25</sup> @ 125°C (Amps)	DCR (mΩ) @ 20°C	K-factor <sup>6</sup>
R1 Version							
FP1006R1-R08-R	85	61	53	100	70	0.27 ± 12%	454
FP1006R1-R10-R	100	72		85	64		454
FP1006R1-R12-R	120	86		71	53		454
FP1006R1-R16-R	160	115		55	40		454
FP1006R1-R22-R	220	158		38	28		454
R2 Version							
FP1006R2-R08-R	85	61	45	100	70	0.36 ± 8.6%	454
FP1006R2-R10-R	100	72		85	64		454
FP1006R2-R12-R	120	86		71	53		454
FP1006R2-R16-R	160	115		55	40		454
FP1006R2-R22-R	220	158		38	28		454

1 Open Circuit Inductance (OCL) Test Parameters: 100kHz, 0.10V<sub>rms</sub>, 0.0Adc

2 Full Load Inductance (FLL) Test Parameters: 100kHz, 0.1V<sub>rms</sub>, I<sub>sat</sub><sup>1</sup>

3 I<sub>rms</sub>: DC current for an approximate temperature rise of 40°C without core loss. Derating is necessary for AC currents. PCB pad layout, trace thickness and width, air-flow and proximity of other heat generating components will affect the temperature rise. It is recommended the part temperature not exceed 125°C under worst case operating conditions verified in the end application.

4 I<sub>sat</sub><sup>1</sup>: Peak current for approximately 20% rolloff at +25°C.

5 I<sub>sat</sub><sup>2</sup>: Peak current for approximately 20% rolloff at +125°C.

6 K-factor: Used to determine B<sub>p-p</sub> for core loss (see graph). B<sub>p-p</sub> = K \* L \* ΔI \* 10<sup>-3</sup>, B<sub>p-p</sub>: (Gauss), K: (K-factor from table), L: (inductance in nH), ΔI (peak-to-peak ripple current in amps).

7 Part Number Definition: FP1006Rx-Rxx-R

• FP1006 = Product code and size

• Rxx= Inductance value in μH, R = decimal point

• Rx is the DCR indicator

• "-R" suffix = RoHS compliant

## FLAT-PAC™ FP1006 Series

### Dimensions - mm

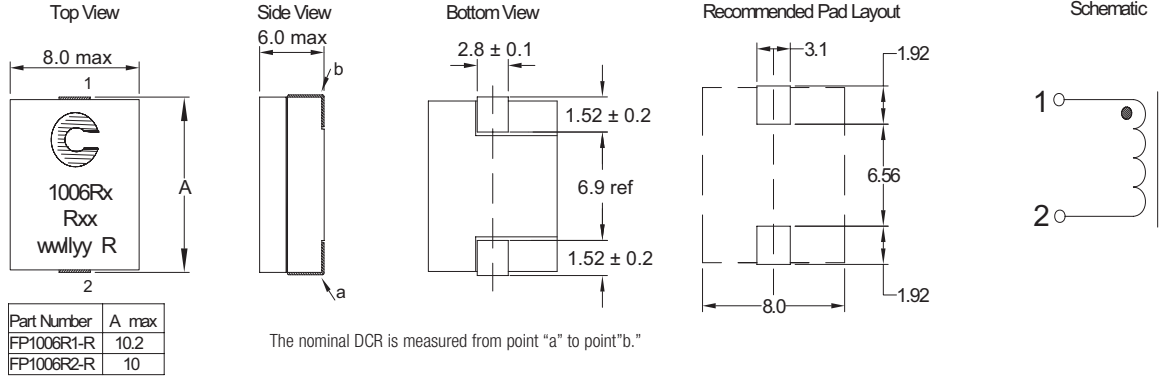

Part Marking: Coiltronics Logo    1006Rx (Rx = DCR Indicator)    Rxx = Inductance value in  $\mu\text{H}$ . (R = Decimal point)    wwlyyy = Date code    R = Revision level

### Packaging Information - mm

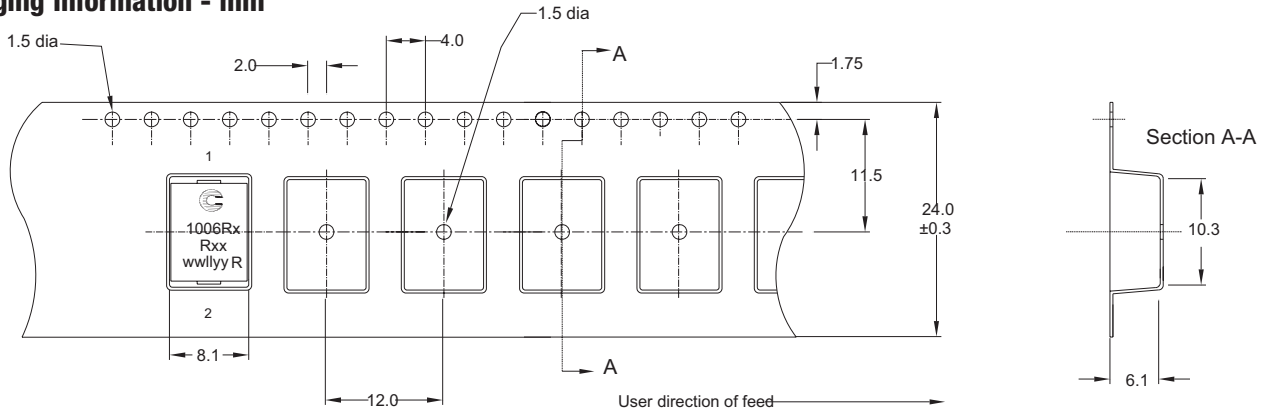

### Temperature Rise vs. Total Loss

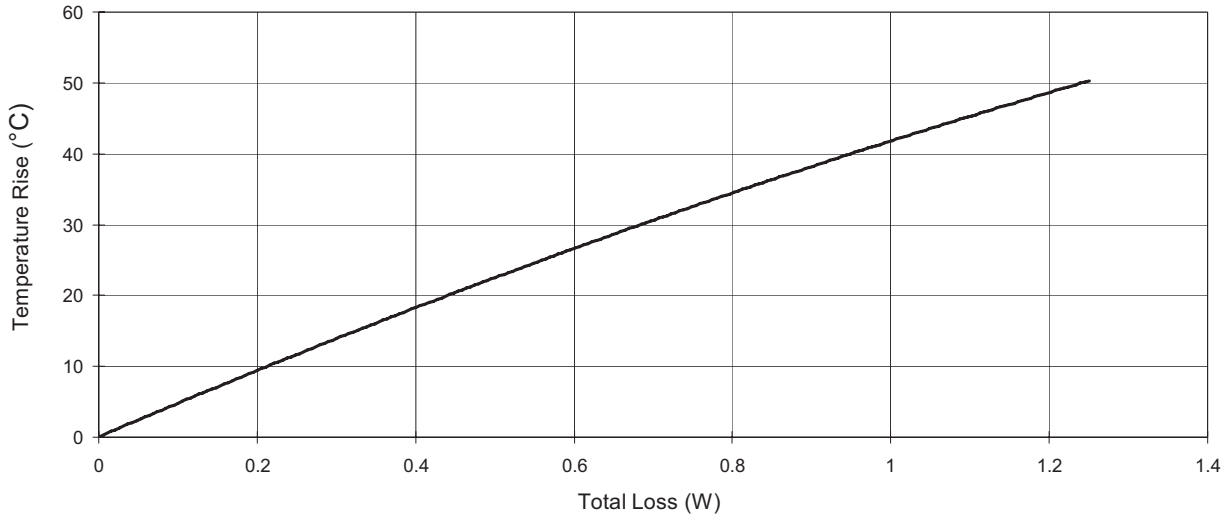

FLAT-PAC™ FP1006 Series

Core Loss

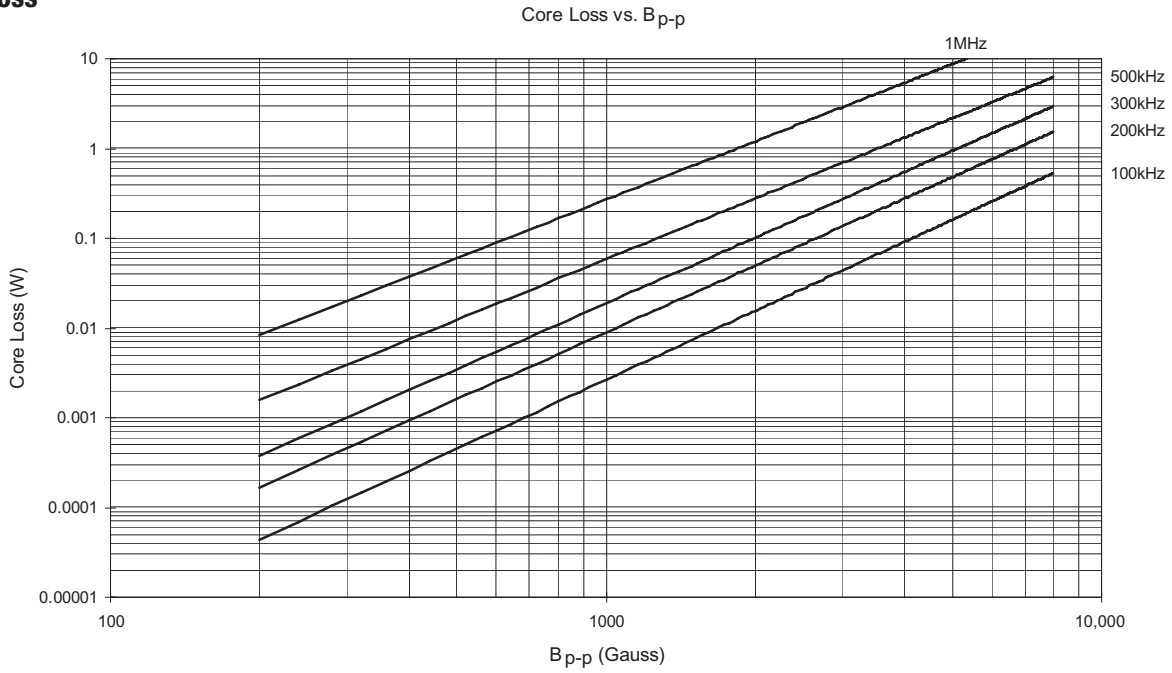

FLAT-PAC™ Series

Inductance Characteristics

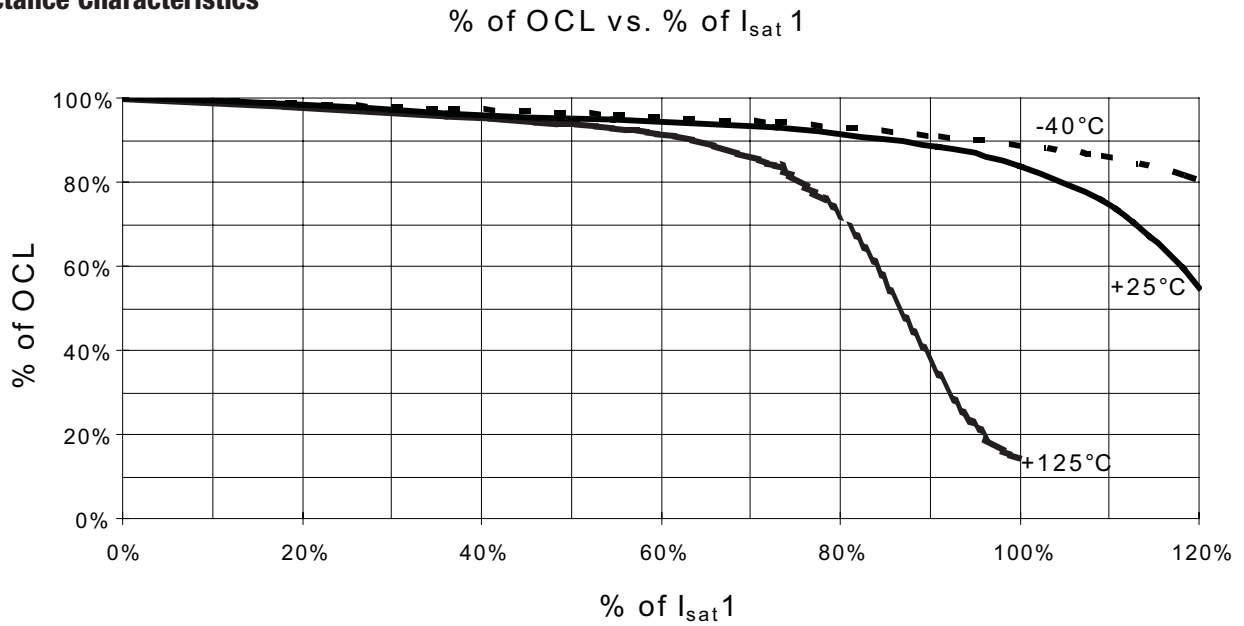

## FLAT-PAC™ FP1007 Series



SMD Device

### Applications:

- Multi-phase regulators
- Voltage Regulator Module (VRM)
- Desktop and server VRMs and EVRDs
- Notebook regulators
- Data networking and storage systems
- Graphics cards and battery power systems
- Point-of-load modules
- DCR sensing



### Environmental Data:

- Storage temperature range: -40°C to +125°C
- Operating temperature range: -40°C to +125°C (Range is application specific)
- Solder reflow temperature: J-STD-020D compliant

### Packaging:

- Supplied in tape-and-reel packaging on 13" diameter reel
- FP1007R1 700 parts per reel
- FP1007R2 750 parts per reel

### Description:

- Halogen free
- 125°C maximum total temperature operation
- 8.0 x 10.41 x 7.0mm surface mount package
- Ferrite core material
- High current carrying capacity, low core losses
- Controlled DCR tolerance for sensing circuits
- Inductance range from 120nH to 300nH
- Current range from 32 to 81 amps
- Frequency range up to 2MHz
- RoHS compliant

### Product Specifications

Part Number <sup>7</sup>	OCL <sup>1</sup> ± 10% (nH)	FLL <sup>2</sup> Min. (nH)	I <sub>rms</sub> <sup>3</sup> (Amps)	I <sub>sat</sub> <sup>14</sup> @ 25°C (Amps)	I <sub>sat</sub> <sup>25</sup> @ 125°C (Amps)	DCR (mΩ) @ 20°C	K-factor <sup>6</sup>
R1 Version							
FP1007R1-R12-R	120	86	60	81	65	0.29 ± 10%	371
FP1007R1-R14-R	140	100		72	56		371
FP1007R1-R17-R	170	122		58	46		371
FP1007R1-R22-R	215	155		50	36		371
FP1007R1-R30-R	300	216		32	26		371
R2 Version							
FP1007R2-R12-R	120	86	51	81	65	0.48 ± 8%	368
FP1007R2-R14-R	140	100		72	56		368
FP1007R2-R17-R	170	122		58	46		368
FP1007R2-R22-R	215	155		50	36		368
FP1007R2-R30-R	300	216		32	26		368

1 Open Circuit Inductance (OCL) Test Parameters: 100kHz, 0.10V<sub>rms</sub>, 0.0Adc

2 Full Load Inductance (FLL) Test Parameters: 100kHz, 0.1V<sub>rms</sub>, I<sub>sat</sub><sup>1</sup>

3 I<sub>rms</sub>: DC current for an approximate temperature rise of 40°C without core loss. Derating is necessary for AC currents. PCB pad layout, trace thickness and width, air-flow and proximity of other heat generating components will affect the temperature rise. It is recommended the part temperature not exceed 125°C under worst case operating conditions verified in the end application.

4 I<sub>sat</sub><sup>1</sup>: Peak current for approximately 20% rolloff at +25°C.

5 I<sub>sat</sub><sup>2</sup>: Peak current for approximately 20% rolloff at +125°C.

6 K-factor: Used to determine B<sub>p-p</sub> for core loss (see graph). B<sub>p-p</sub> = K \* L \* ΔI \* 10<sup>-3</sup>, B<sub>p-p</sub>: (Gauss), K: (K-factor from table), L: (inductance in nH), ΔI (peak-to-peak ripple current in amps).

7 Part Number Definition: FP1007Rx-Rxx-R

• FP1007 = Product code and size

• Rxx= Inductance value in μH, R = decimal point

• Rx is the DCR indicator

• "-R" suffix = RoHS compliant

## FLAT-PAC™ FP1007 Series

### Dimensions - mm

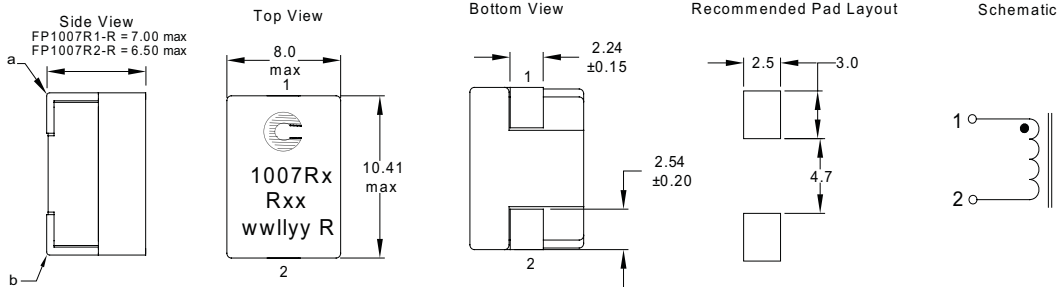

The nominal DCR is measured from point "a" to point "b."

Part Marking: Coiltronics Logo    1007Rx (Rx = DCR Indicator)    Rxx = Inductance value in  $\mu\text{H}$ . (R = Decimal point)    wwlyy = Date code    R = Revision level

### Packaging Information - mm

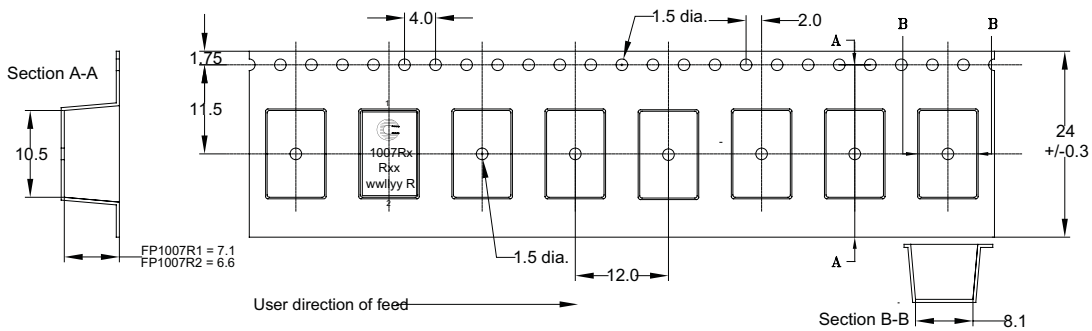

Supplied in tape-and-reel packaging, on 13" diameter reel; FP1007R1 700 parts, FP1007R2 750 parts

### Temperature Rise vs. Total Loss

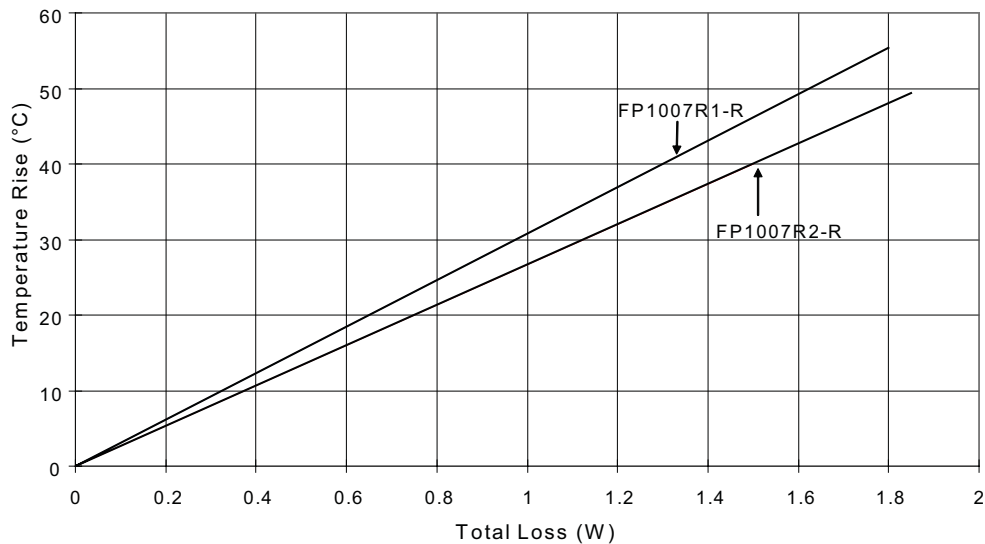

FLAT-PAC™ FP1007 Series

Core Loss

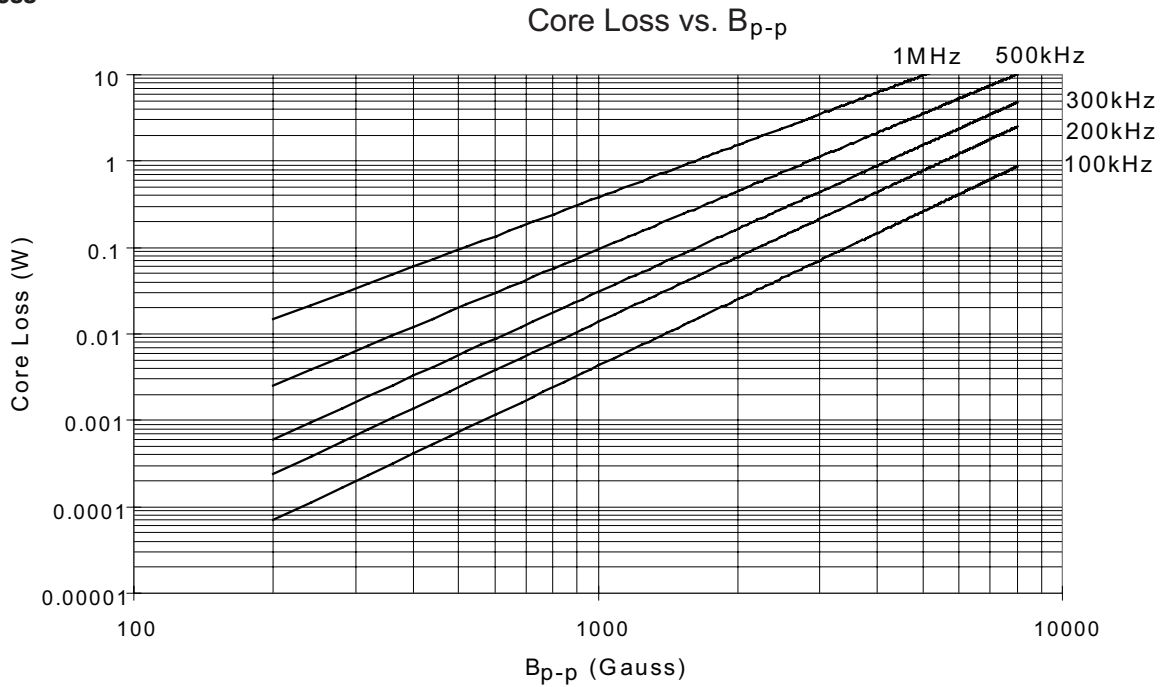

Inductance Characteristics

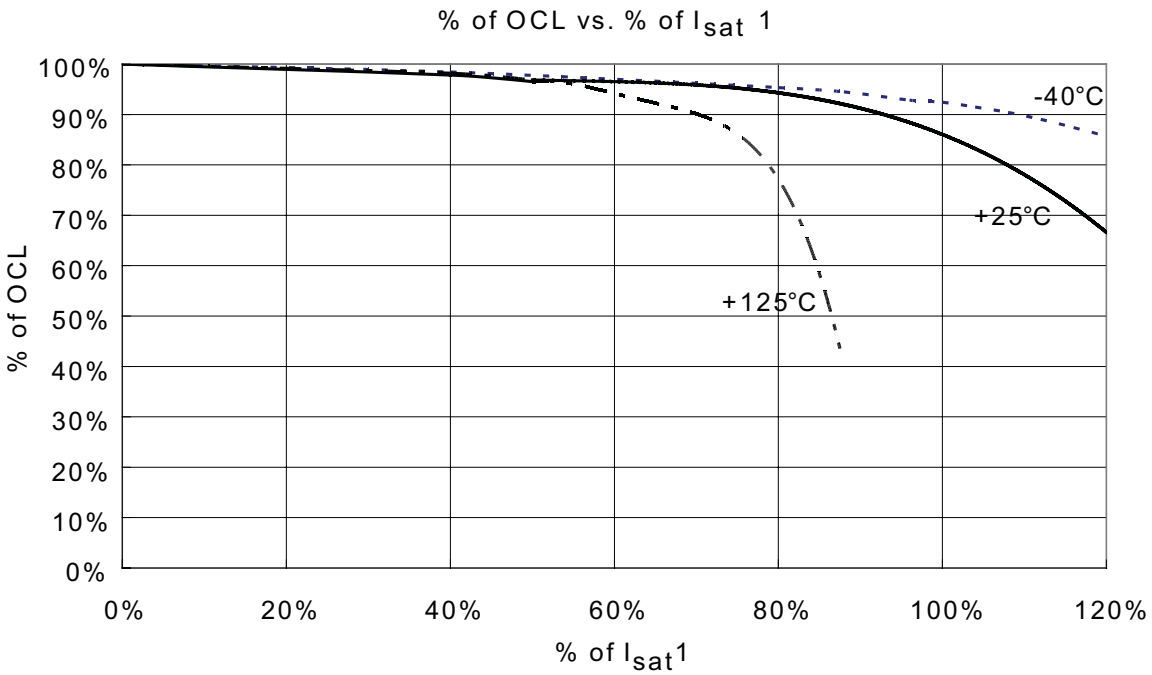



## FLAT-PAC™ FP1105 Series

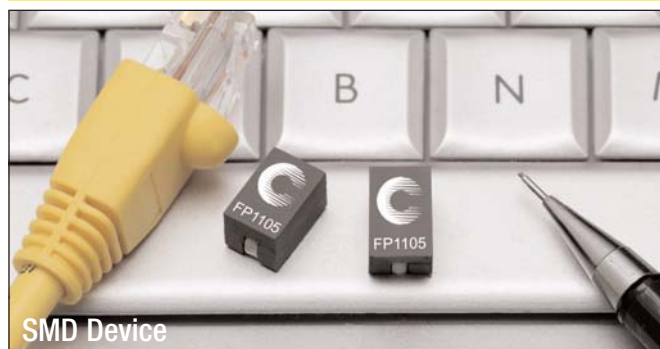

FLAT-PAC™ Series

### Description

- Halogen free
- 125°C maximum total temperature operation
- 11.0 x 8.0 x 4.90mm surface mount package
- Ferrite core material
- High current carrying capacity
- Low core losses
- Controlled DCR tolerance for sensing circuits
- Inductance range from 101nH to 226nH
- Current range from 39 to 81 amps
- Frequency range up to 2MHz
- RoHS compliant

### Applications

- Multi-phase regulators
- Voltage Regulator Module (VRM)
- Portable electronics
- Servers and workstations
- Data networking and storage systems
- Notebook and desktop computers
- Graphics cards and battery power systems
- DCR sensing

### Environmental Data

- Storage temperature range: -40°C to +125°C
- Operating temperature range: -40°C to +125°C (Range is application specific)
- Solder reflow temperature: J-STD-020D compliant

### Packaging

- Supplied in tape-and-reel packaging, 900 parts per reel, 13" diameter reel

### Product Specifications

Part Number	OCL <sup>1</sup> ± 10% (nH)	FLL <sup>2</sup> Min. (nH)	I <sub>rms</sub> <sup>3</sup> (Amps)	I <sub>sat</sub> <sup>14</sup> @ 25°C (Amps)	I <sub>sat</sub> <sup>25</sup> @ 125°C (Amps)	DCR (mΩ) @ 20°C	K-factor <sup>6</sup>
FP1105R1-R10-R	100	72	46	81	63	0.35 ± 8.6%	467
FP1105R1-R12-R	120	86		66	50		467
FP1105R1-R15-R	150	109		54	42		467
FP1105R1-R20-R	192	138		42	34		467
FP1105R1-R22-R	226	163		39	28		467

1 Open Circuit Inductance (OCL) Test Parameters: 100kHz, 0.10V<sub>rms</sub>, 0.0A<sub>dc</sub>

2 Full Load Inductance (FLL) Test Parameters: 100kHz, 0.1V<sub>rms</sub>, I<sub>sat</sub><sup>1</sup>

3 I<sub>rms</sub>: DC current for an approximate temperature rise of 40°C without core loss. Derating is necessary for AC currents. PCB pad layout, trace thickness and width, air-flow and proximity of other heat generating components will affect the temperature rise. It is recommended the part temperature not exceed 125°C under worst case operating conditions verified in the end application.

4 I<sub>sat</sub><sup>1</sup>: Peak current for approximately 20% rolloff at +25°C.

5 I<sub>sat</sub><sup>2</sup>: Peak current for approximately 20% rolloff at +125°C.

6 K-factor: Used to determine B<sub>p-p</sub> for core loss (see graph). B<sub>p-p</sub> = K \* L \* ΔI \* 10<sup>-3</sup>, B<sub>p-p</sub>: (Gauss), K: (K-factor from table), L: (inductance in nH), ΔI (peak-to-peak ripple current in amps).

7 Part Number Definition: FP1105Rx-Rxx-R

• FP1105 = Product code and size

• Rxx= Inductance value in μH, R = decimal point

• Rx is the DCR indicator

• "-R" suffix = RoHS compliant

## FLAT-PAC™ FP1105 Series

**Dimensions - mm**    A = 11.0 Max.    B = 8.0 Max.    C = 4.9 Max.    D = 2.4 ± 0.2    E = 2.3 ± 0.3    F = 6.2 Typ.

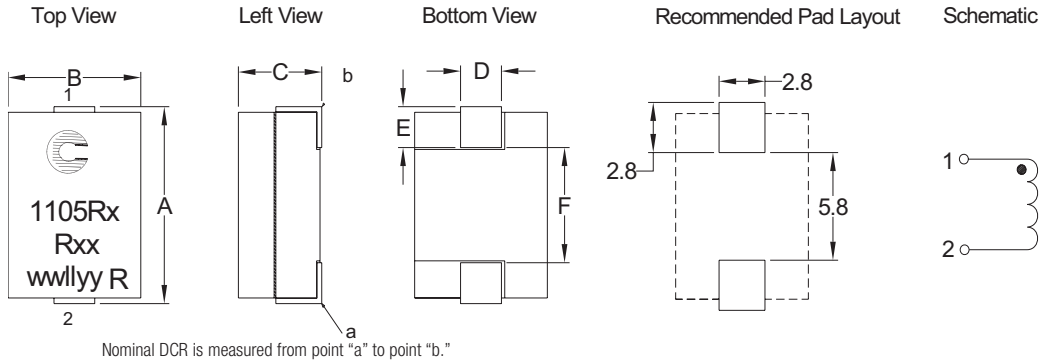

Part Marking: Coiltronics Logo    1105Rx (Rx = DCR indicator)    Rxx = inductance value in  $\mu\text{H}$  (R = decimal point)    wwlyy = date code    R = revision level

## Packaging Information - mm

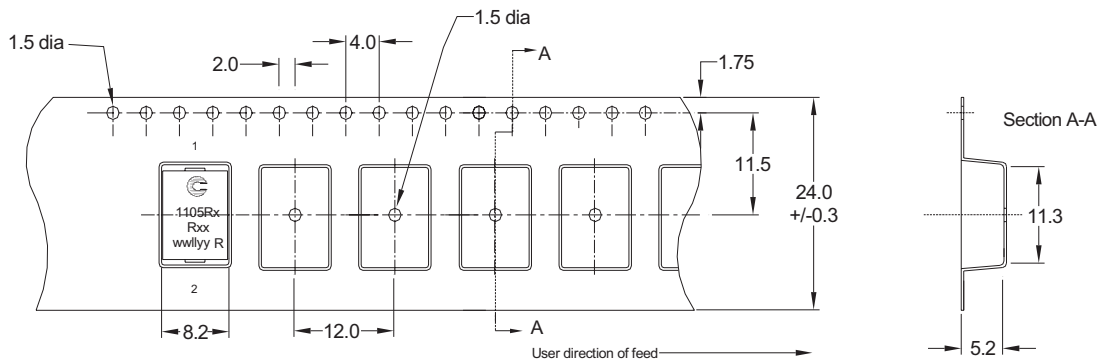

Supplied in tape-and-reel packaging, 900 parts per reel, 13" diameter reel.

## Temperature Rise vs. Total Loss

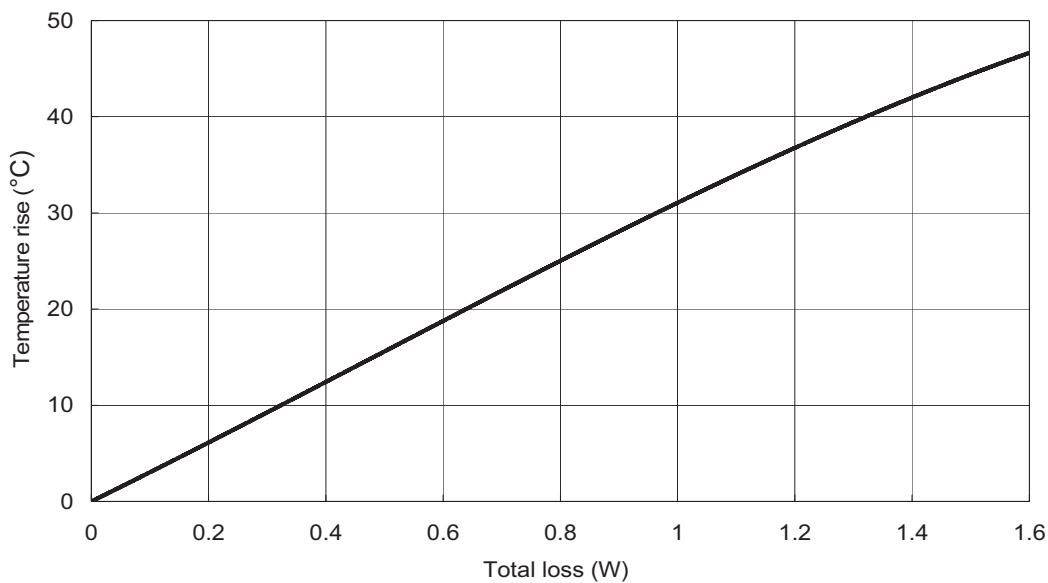

FLAT-PAC™ FP1105 Series

Core Loss

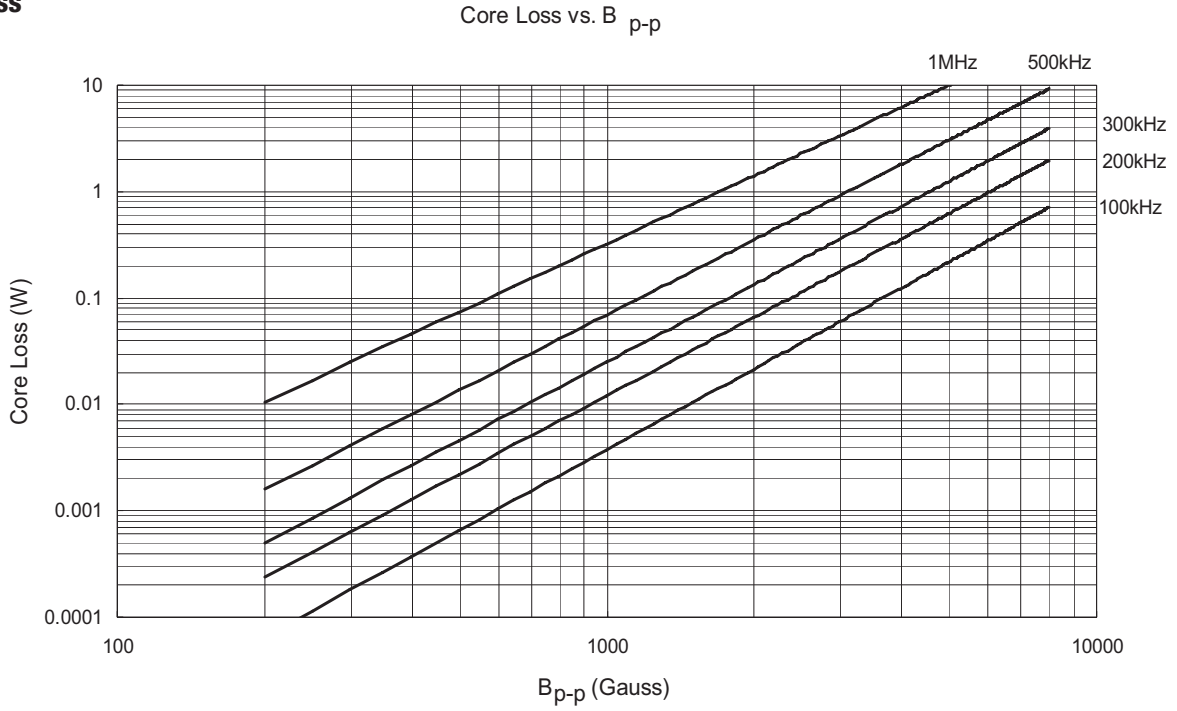

FLAT-PAC™ Series

Inductance Characteristics

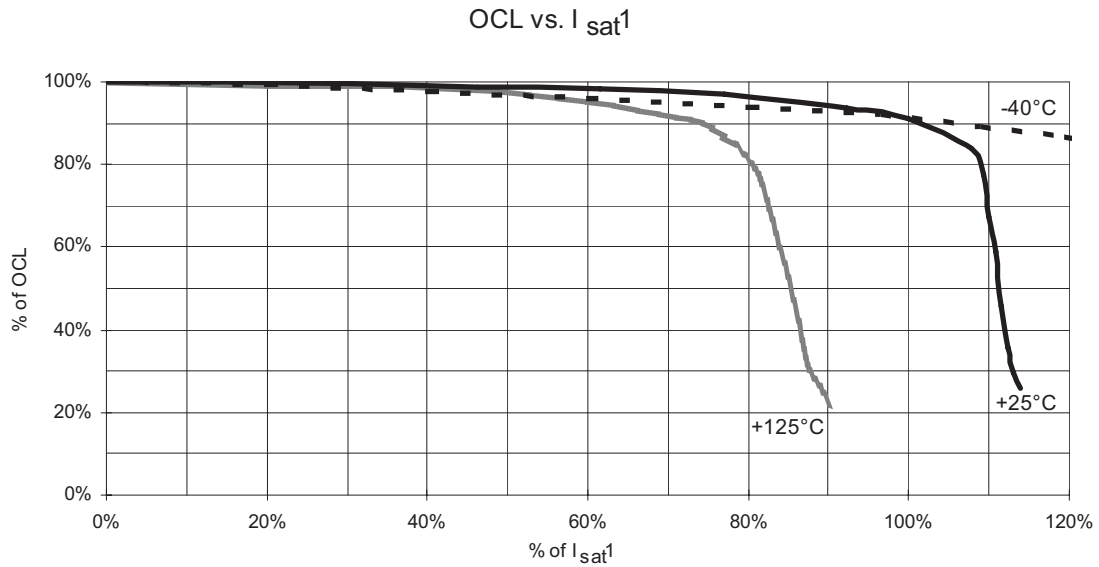

## FLAT-PAC™ FP1107 Series



### Description:

- Halogen free
- 125°C maximum total temperature operation
- 7.2 x 11.0 x 7.5mm surface mount package
- Ferrite core material
- High current carrying capacity, low core losses
- Controlled DCR tolerance for sensing circuits
- Inductance range from 70nH to 510nH
- Current range from 18 to 140 amps
- Frequency range up to 2MHz
- RoHS compliant

### Applications:

- Multi-phase regulators
- Voltage Regulator Module (VRM)
- Desktop and server VRMs and EVRDs
- Data networking and storage systems
- Notebook regulators
- Graphics cards and battery power systems
- Point-of-load modules
- DCR sensing



### Environmental Data:

- Storage temperature range: -40°C to +125°C
- Operating temperature range: -40°C to +125°C (Range is application specific)
- Solder reflow temperature: J-STD-020D compliant

### Packaging:

- Supplied in tape-and-reel packaging, 640 parts per reel, 13" diameter reel

### Product Specifications

Part Number <sup>7</sup>	OCL <sup>1</sup> ± 10% (nH)	FLL <sup>2</sup> Min. (nH)	I <sub>rms</sub> <sup>3</sup> (Amps)	I <sub>sat</sub> <sup>14</sup> @ 25°C (Amps)	I <sub>sat</sub> <sup>25</sup> @ 125°C (Amps)	DCR (mΩ) @ 20°C	K-factor <sup>6</sup>
R1 Version							
FP1107R1-R07-R	70	50	55	140	123	0.29 ± 10%	361.1
FP1107R1-R12-R	120	86		90	72		361.1
FP1107R1-R15-R	150	108		70	56		361.1
FP1107R1-R23-R	230	166		45	36		361.1
FP1107R1-R30-R	300	217		35	28		361.1
FP1107R1-R40-R	400	288		25	20		361.1
FP1107R1-R51-R	510	364		18	14.5		361.1
R2 Version							
FP1107R2-R07-R	70	50	42	140	123	0.47 ± 6.4%	363.3
FP1107R2-R12-R	120	86		90	72		363.3
FP1107R2-R15-R	150	108		70	56		363.3
FP1107R2-R23-R	230	166		45	36		363.3
FP1107R2-R30-R	300	217		35	28		363.3
FP1107R2-R40-R	400	288		25	20		363.3
FP1107R2-R51-R	510	364		18	14.5		363.3

1 Open Circuit Inductance (OCL) Test Parameters: 100kHz, 0.10V<sub>rms</sub>, 0.0Adc

2 Full Load Inductance (FLL) Test Parameters: 100kHz, 0.1V<sub>rms</sub>, I<sub>sat</sub><sup>1</sup>

3 I<sub>rms</sub>: DC current for an approximate temperature rise of 40°C without core loss. Derating is necessary for AC currents. PCB pad layout, trace thickness and width, air-flow and proximity of other heat generating components will affect the temperature rise. It is recommended the part temperature not exceed 125°C under worst case operating conditions verified in the end application.

4 I<sub>sat</sub><sup>1</sup>: Peak current for approximately 20% rolloff at +25°C.

5 I<sub>sat</sub><sup>2</sup>: Peak current for approximately 20% rolloff at +125°C.

6 K-factor: Used to determine B<sub>p-p</sub> for core loss (see graph). B<sub>p-p</sub> = K \* L \* ΔI \* 10<sup>-3</sup>, B<sub>p-p</sub>: (Gauss), K: (K-factor from table), L: (inductance in nH), ΔI (peak-to-peak ripple current in amps).

7 Part Number Definition: FP1107Rx-Rxx-R

- FP1107 = Product code and size
- Rx is the DCR indicator
- Rxx= Inductance value in μH, R = decimal point
- "-R" suffix = RoHS compliant

FLAT-PAC™ FP1107 Series

Dimensions - mm

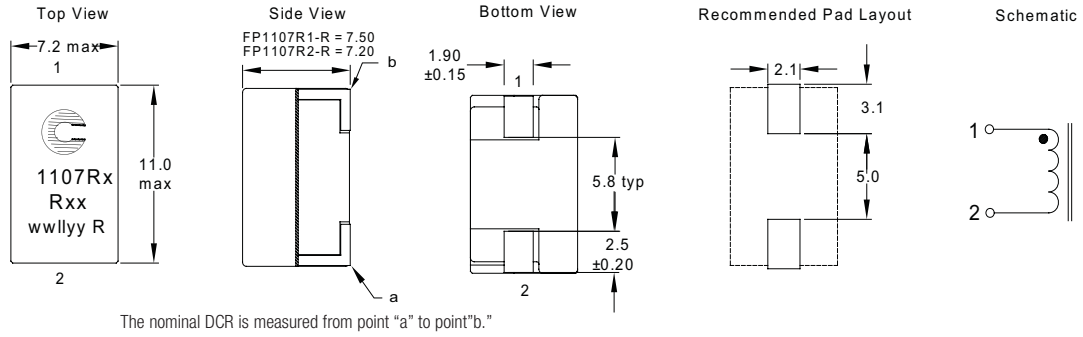

Part Marking: Coiltronics Logo    1107Rx (Rx = DCR Indicator)    Rxx = Inductance value in  $\mu\text{H}$ . (R = Decimal point)    wwlyy = Date code    R = Revision level

Packaging Information - mm

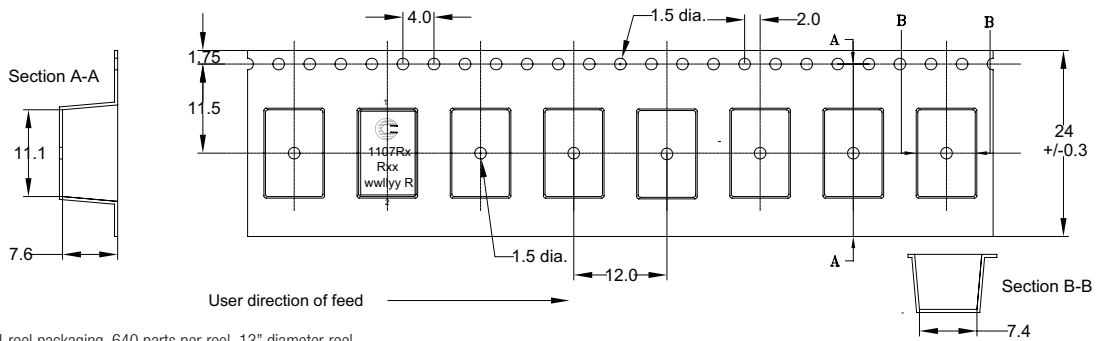

Supplied in tape-and-reel packaging, 640 parts per reel, 13" diameter reel.

Temperature Rise vs. Total Loss

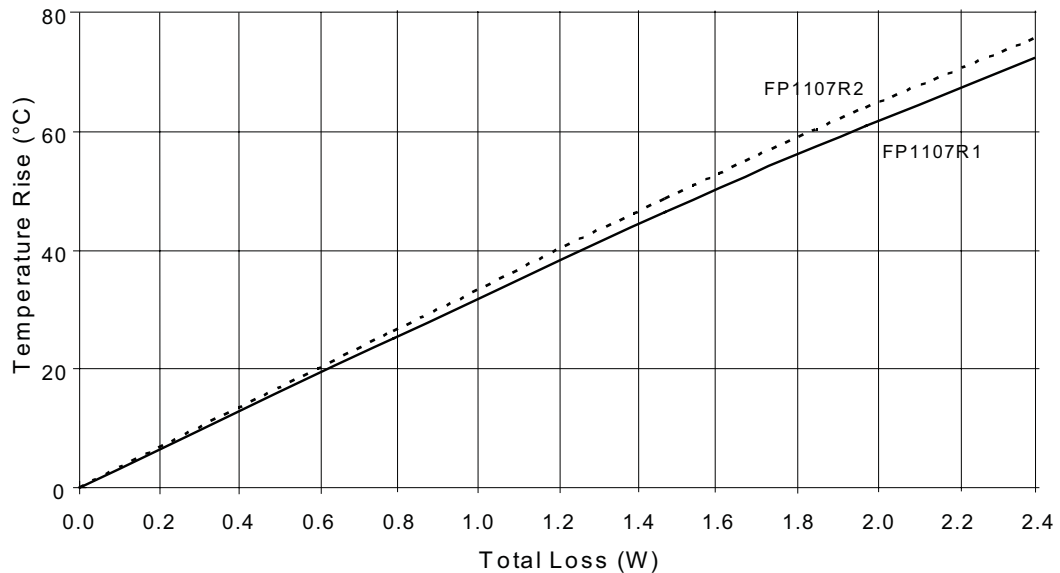

FLAT-PAC™ Series

FLAT-PAC™ FP1107 Series

Core Loss

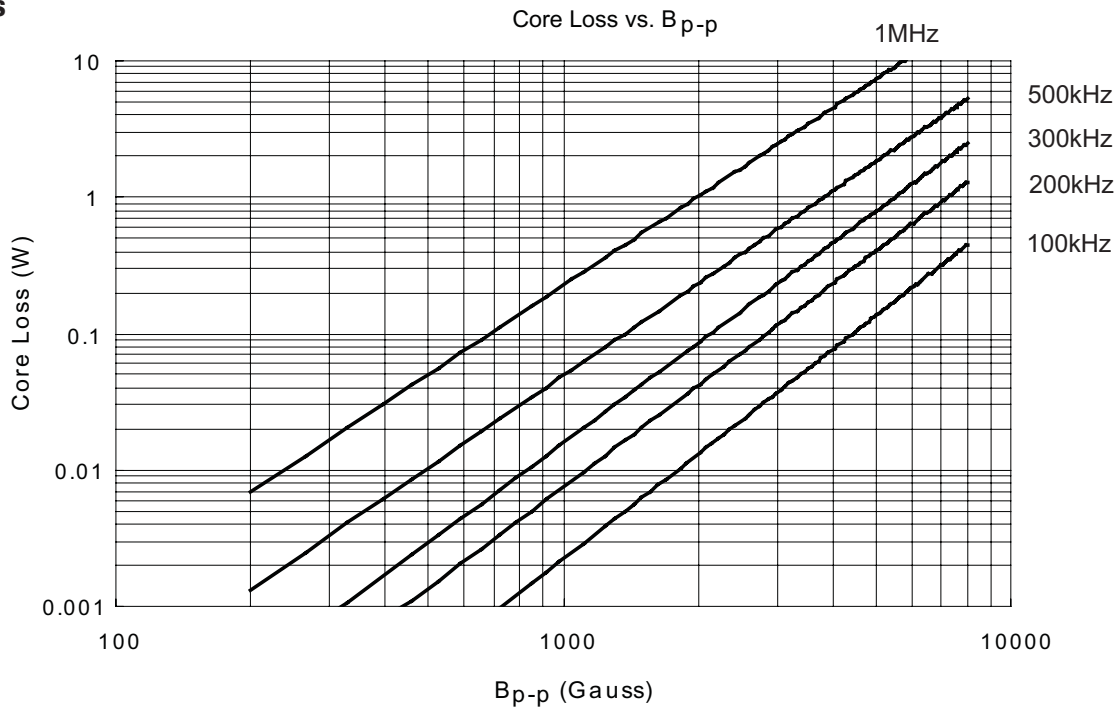

Inductance Characteristics

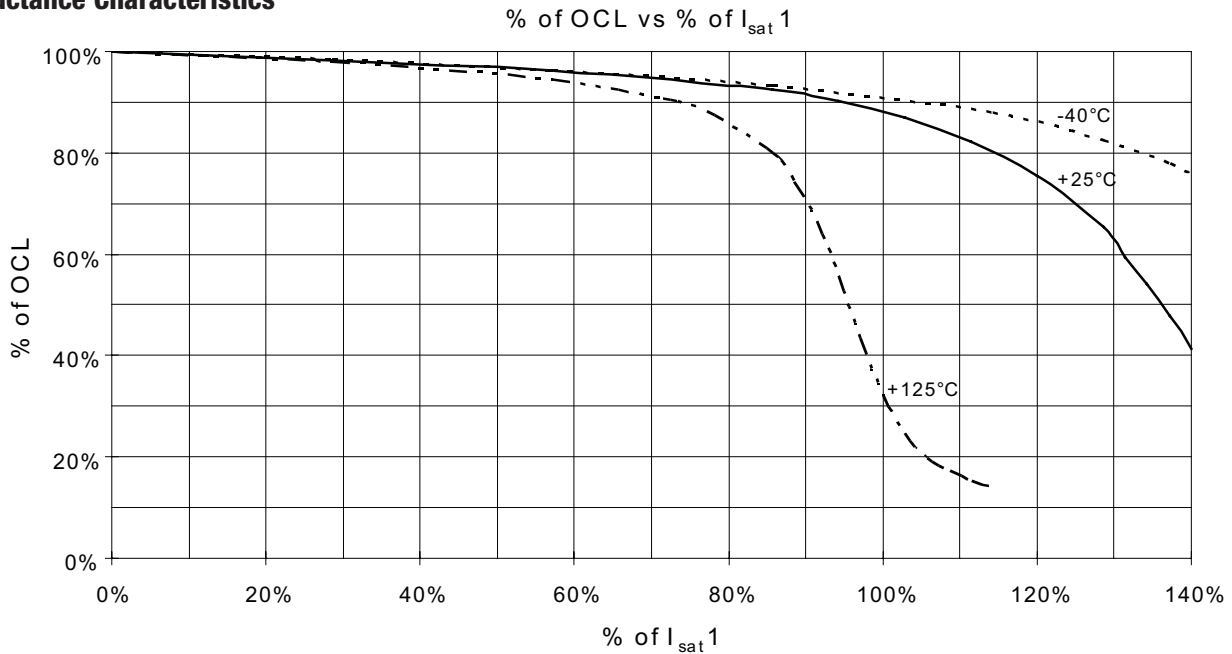

## FLAT-PAC™ FP1109 Series



**SMD Device**

### Applications:

- Multi-phase regulators
- Voltage Regulator Module (VRM)
- Desktop and server VRMs and EVRDs
- Data networking and storage systems
- Notebook regulators
- Graphics cards and battery power systems
- Point-of-load modules
- DCR sensing



FLAT-PAC™ Series

### Environmental Data:

- Storage temperature range: -40°C to +125°C
- Operating temperature range: -40°C to +125°C (Range is application specific)
- Solder reflow temperature: J-STD-020D compliant

### Packaging:

- Supplied in tape-and-reel packaging, 350 parts per reel, 13" diameter reel

### Description:

- Halogen free
- 125°C maximum total temperature operation
- 11.2 x 11.2 x 9.0mm surface mount package
- Ferrite core material
- High current carrying capacity, low core losses
- Controlled DCR tolerance for sensing circuits
- Inductance range from 205nH to 950nH
- Current range from 11.5 to 69 amps
- Frequency range up to 2MHz
- RoHS compliant

Product Specifications							
Part Number <sup>7</sup>	OCL <sup>1</sup> ± 10% (nH)	FLL <sup>2</sup> Min. (nH)	I <sub>rms</sub> <sup>3</sup> (Amps)	I <sub>sat</sub> <sup>14</sup> @ 25°C (Amps)	I <sub>sat</sub> <sup>25</sup> @ 125°C (Amps)	DCR (mΩ) @ 20°C	K-factor <sup>6</sup>
FP1109-R20-R	205	122	35	69	52	0.42 ±10%	233
FP1109-R23-R	247	147		55	41		233
FP1109-R27-R	270	160		51	38		233
FP1109-R33-R	311	185		44	33		233
FP1109-R47-R	463	275		27	20		233
FP1109-R58-R	548	325		22.5	17		233
FP1109-1R0-R	950	565		11.5	8.5		233

1 Open Circuit Inductance (OCL) Test Parameters: 100kHz, 0.10V<sub>rms</sub>, 0.0Adc

2 Full Load Inductance (FLL) Test Parameters: 100kHz, 0.1V<sub>rms</sub>, I<sub>sat</sub><sup>1</sup>

3 I<sub>rms</sub>: DC current for an approximate temperature rise of 40°C without core loss. Derating is necessary for AC currents. PCB pad layout, trace thickness and width, air-flow and proximity of other heat generating components will affect the temperature rise. It is recommended the part temperature not exceed 125°C under worst case operating conditions verified in the end application.

4 I<sub>sat</sub><sup>1</sup>: Peak current for approximately 30% rolloff at +25°C.

5 I<sub>sat</sub><sup>2</sup>: Peak current for approximately 30% rolloff at +125°C.

6 K-factor: Used to determine B<sub>p-p</sub> for core loss (see graph). B<sub>p-p</sub> = K \* L \* ΔI \* 10<sup>-3</sup>, B<sub>p-p</sub>: (Gauss), K: (K-factor from table), L: (inductance in nH), ΔI (peak-to-peak ripple current in amps).

7 Part Number Definition: FP1109-xxx-R

- FP1109 = Product code and size
- xxx= Inductance value in μH, R = decimal point. If no "R" is present, then third character = # of zeros
- "-R" suffix = RoHS compliant

## FLAT-PAC™ FP1109 Series

### Dimensions - mm

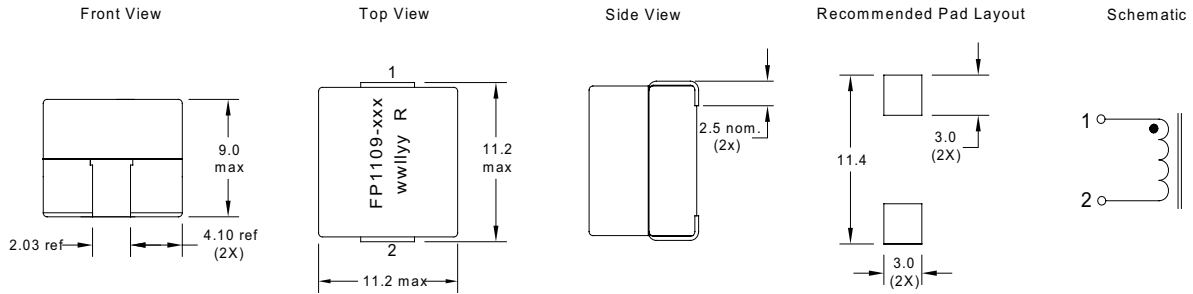

Part Marking: FP1109

xxx = Inductance value in  $\mu\text{H}$ . (R = Decimal point). If no "R" is present, then last character is # of zeros

wwllyy = Date code

R = Revision level

### Packaging Information - mm

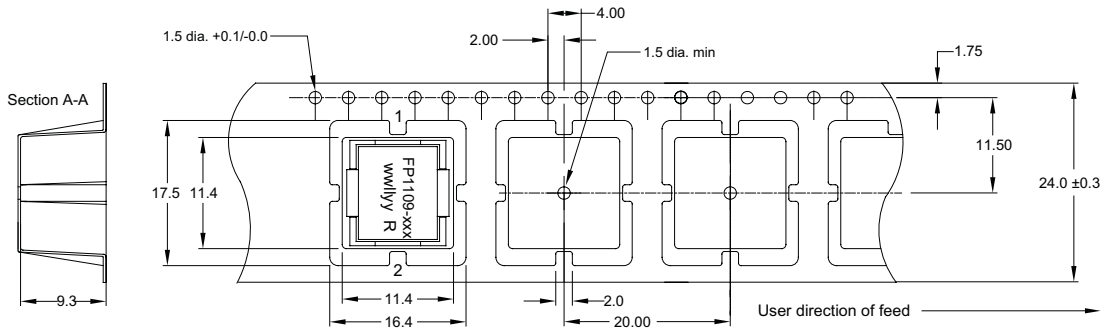

Supplied in tape-and-reel packaging, 350 parts per reel, 13" diameter reel.

### Temperature Rise vs. Total Loss

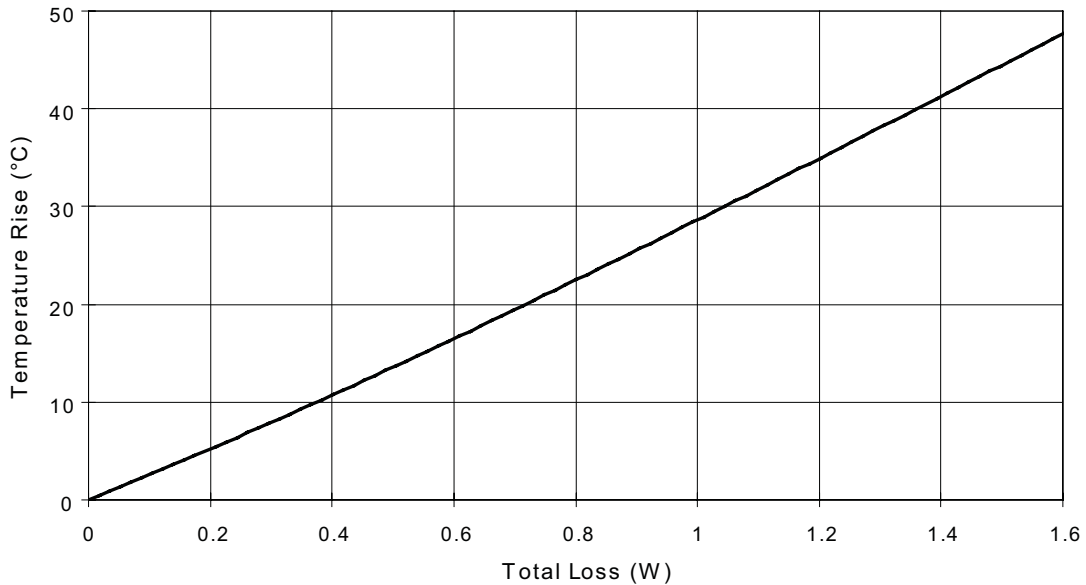



FLAT-PAC™ FP1109 Series

Core Loss

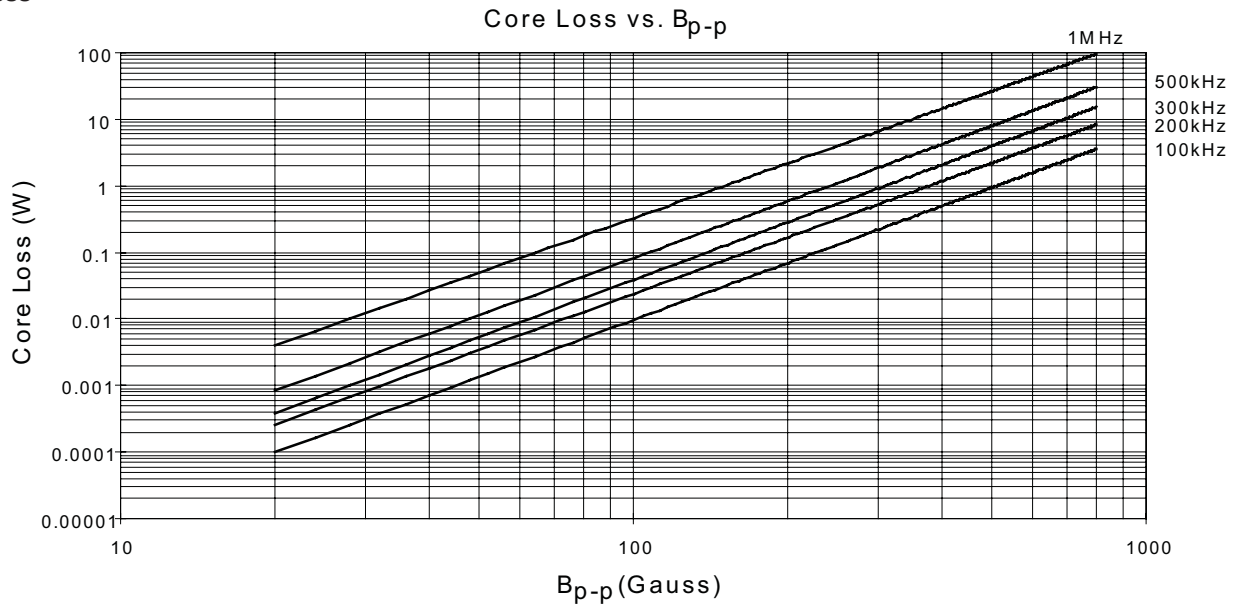

Inductance Characteristics

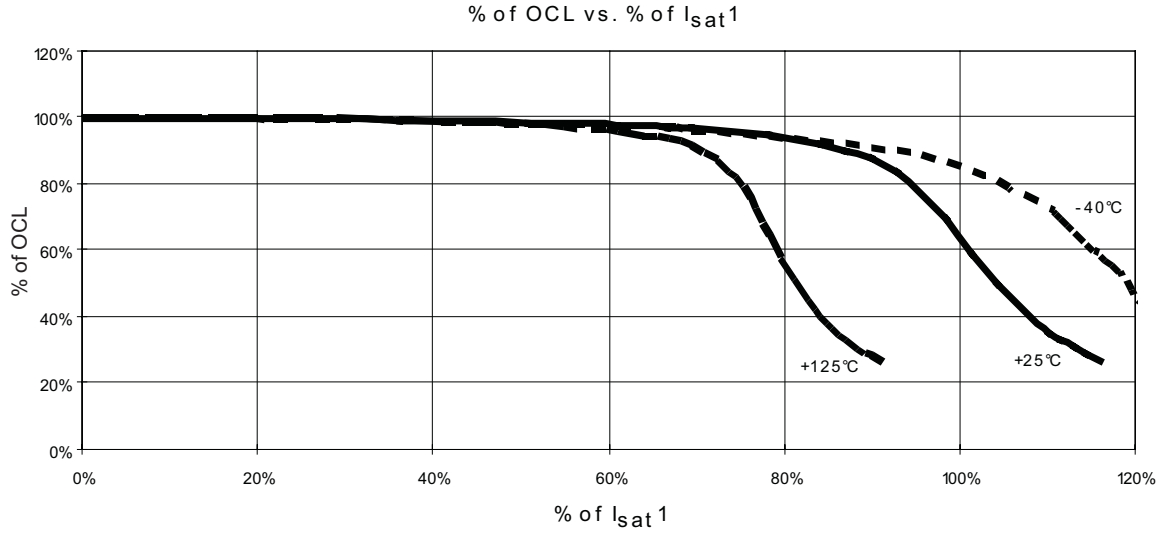

FLAT-PAC™ Series

## FLAT-PAC™ FP1308 Series

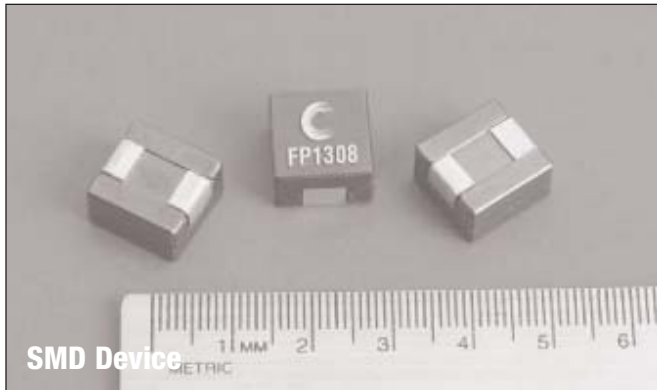

### Description

- 125°C maximum total operating temperature
- 12.9 x 13.7 x 8.0mm surface mount package
- High current handling capability, compact footprint
- Ferrite core material
- Inductance range from 0.110μH to 0.440μH
- Current range from 32 to 120 amps
- Frequency range up to 2MHz

### Applications

- Voltage regulator modules (VRMs) for servers and microprocessors
- Multi-phase buck inductors
- High frequency, high current switching power supplies



### Environmental Data

- Storage temperature range: -40°C to +125°C
- Operating temperature range: -40°C to +125°C (range is application specific)
- Solder reflow temperature: +260°C max. for 10 seconds maximum

### Packaging

- Supplied in tape-and-reel packaging, 400 parts per 13" diameter reel

### Product Specifications

Part Number <sup>5</sup>	Rated Inductance (μH)	OCL <sup>1</sup> ± 10% (μH)	I <sub>rms</sub> <sup>2</sup> (Amps)	I <sub>sat</sub> <sup>3</sup> (Amps)	DCR (mΩ) @ 25°C Typical	DCR (mΩ) @ 25°C Max	K-factor <sup>4</sup>
FP1308-R11-R	0.110	0.110	68	120	0.20	0.24	21.330
FP1308-R21-R	0.210	0.210	68	72	0.20	0.24	21.333
FP1308-R26-R	0.260	0.260	68	60	0.20	0.24	21.335
FP1308-R32-R	0.320	0.320	68	45	0.20	0.24	21.340
FP1308-R44-R	0.440	0.440	68	32	0.20	0.24	21.366

1 Open Circuit Inductance (OCL) Test Parameters: 100kHz, 0.10V<sub>rms</sub>, 0.0Adc

2 I<sub>rms</sub>: DC current for an approximate temperature rise of 40°C without core loss. Derating is necessary for AC currents. PCB pad layout, trace thickness and width, air-flow and proximity of other heat generating components will affect the temperature rise. It is recommended the part temperature not exceed 125°C under worst case operating conditions verified in the end application.

3 I<sub>sat</sub>: Peak current for approximately 20% rolloff at +25°C.

4 K-factor: Used to determine B<sub>p-p</sub> for core loss (see graph). B<sub>p-p</sub> = K \* L \* ΔI. B<sub>p-p</sub> (mT); K: (K-factor from table), L: (inductance in μH), ΔI (peak-to-peak ripple current in amps).

5 Part Number Definition: FP1308-xxx-R

• FP1308 = Product code and size

• xxx= Inductance value in μH, R = decimal point. If no "R" is present, then third character = # of zeros.

• "-R" suffix = RoHS compliant

FLAT-PAC™ FP1308 Series

Dimensions - mm

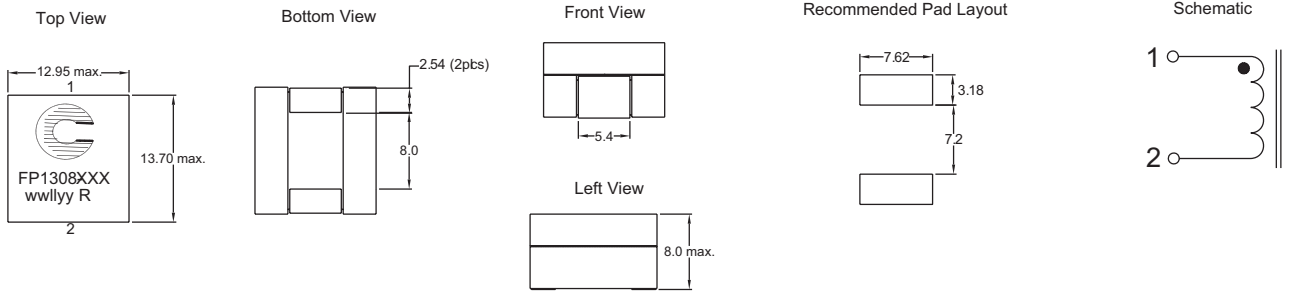

Part Marking: FP1308      xxx = Inductance value in  $\mu\text{H}$ . (R = Decimal point). If no "R" is present, then last character is # Of zeros      wwillyy = Date code      R = Revision level

Packaging Information - mm

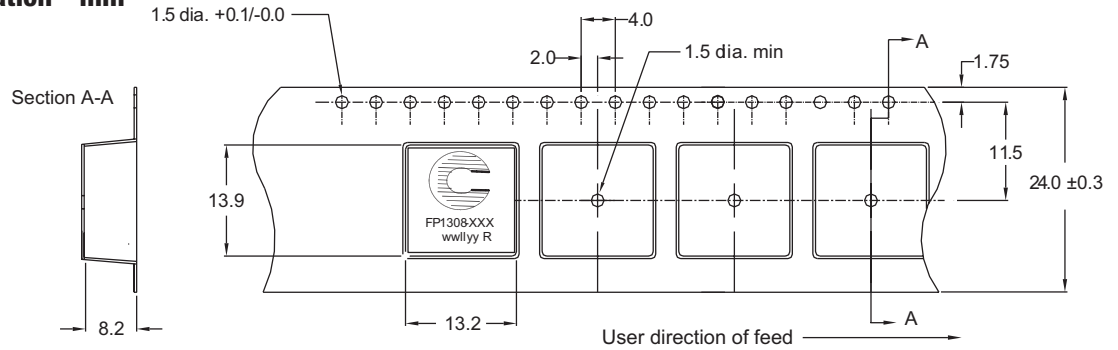

Supplied in tape-and-reel packaging, 400 parts per reel, 13" diameter reel.

Temperature Rise vs. Total Loss

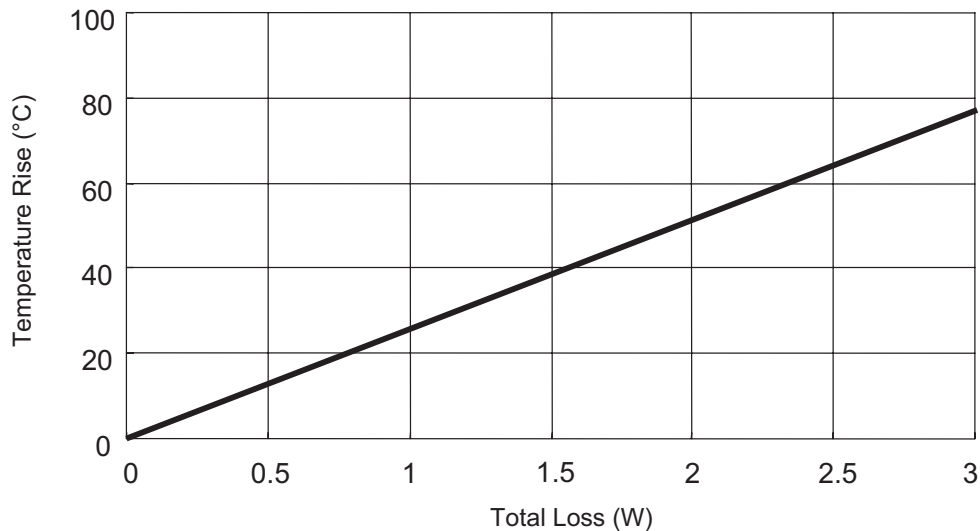

FLAT-PAC™ FP1308 Series

Core Loss

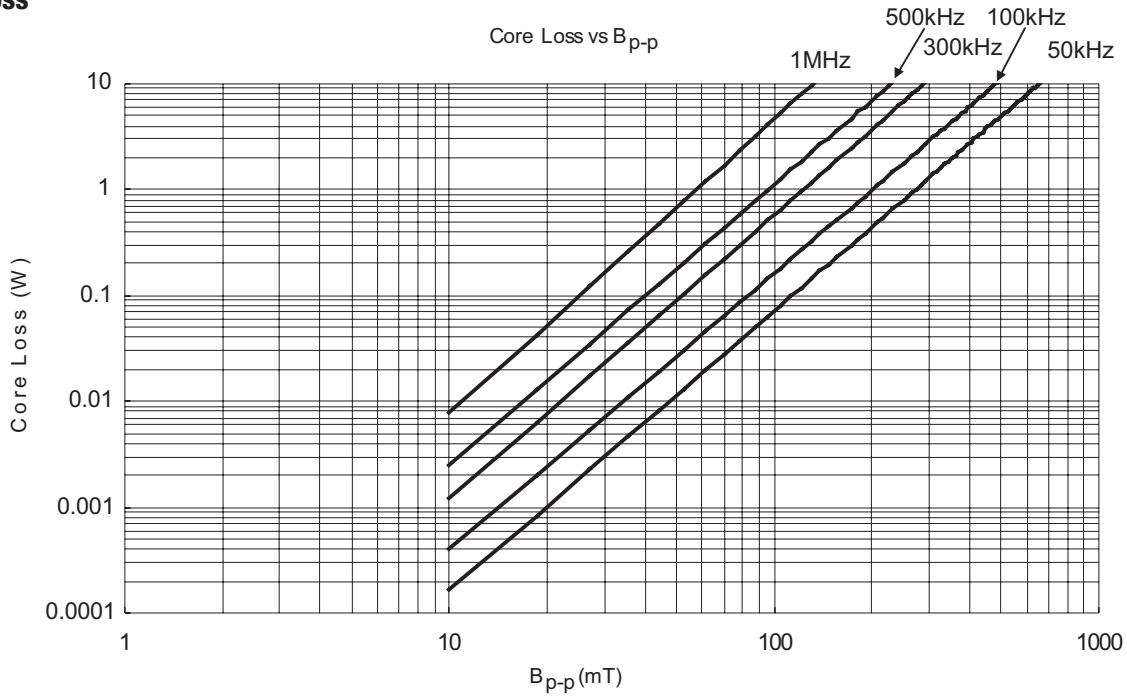

Inductance Characteristics

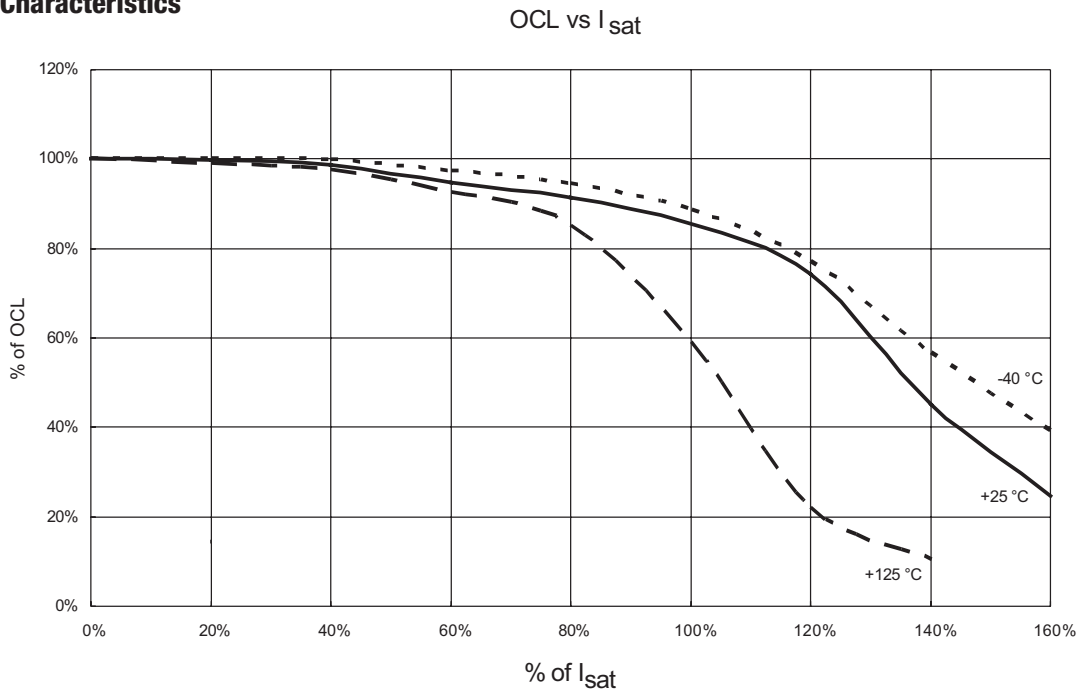

## FLAT-PAC™ FP3 Series

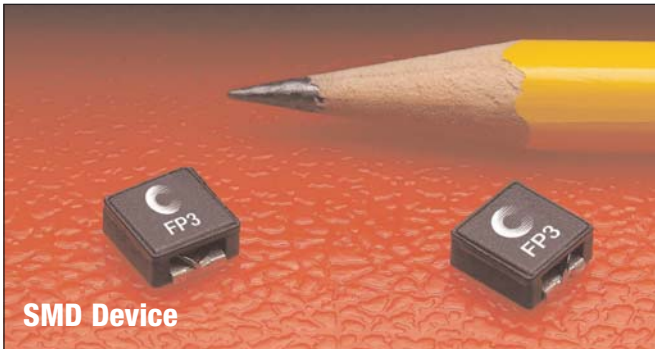

### Applications

- Computers and portable power devices
- Energy storage applications
- DC-DC converters
- Input - output filter application



### Environmental Data

- Storage temperature range: -40°C to +155°C
- Operating ambient temperature range: -40°C to +155°C (Range is application specific)
- Solder reflow temperature: +260°C max. for 10 seconds max.

### Packaging

- Units supplied in tape-and-reel packaging, 1700 parts per reel, 13" diameter reel

### Description

- 155°C maximum total temperature operation
- Low-profile high current inductors
- Inductance range 0.1µH to 15µH
- Design utilizes high temperature powder iron material with a non-organic binder to eliminate thermal aging
- Current rating up to 34.7A<sub>dc</sub> (higher peak currents may be attained with a greater rolloff, see rolloff curve)
- Frequency range up to 2MHz

Product Specifications							
Part Number	Rated Inductance µH	OCL <sup>1</sup> µH ± 15%	I <sub>rms</sub> <sup>2</sup> Amps	I <sub>sat</sub> <sup>3</sup> Amps Approx. 10%	I <sub>sat</sub> <sup>4</sup> Amps Approx. 15%	DCR (mΩ) @ 20°C (Max.)	K-factor <sup>5</sup>
FP3-R10-R	0.10	0.10	19.0	27	34.7	1.21	803
FP3-R20-R	0.20	0.22	15.3	16	20.8	1.88	482
FP3-R47-R	0.47	0.44	10.9	11.6	14.9	3.67	344
FP3-R68-R	0.68	0.72	9.72	9.0	11.6	4.63	268
FP3-1R0-R	1.00	1.10	6.26	7.4	9.5	11.2	219
FP3-1R5-R	1.50	1.50	5.78	6.2	8.0	13.1	185
FP3-2R0-R	2.00	2.00	5.40	5.4	6.9	15.0	161
FP3-3R3-R	3.30	3.20	3.63	4.3	5.5	30.0	127
FP3-4R7-R	4.70	4.70	3.23	3.5	4.2	40.0	105
FP3-8R2-R	8.20	8.5	2.91	2.6	3.4	74.0	78
FP3-100-R	10.0	10.9	2.30	2.3	3.0	101	69
FP3-150-R	15.0	14.9	2.22	2.0	2.5	127	59

1 OCL (Open Circuit Inductance) Test parameters: 100kHz, 0.1V<sub>rms</sub>, 0.0A<sub>dc</sub>

2 DC current for an approximate ΔT of 40°C without core loss. Derating is necessary for AC currents. PCB layout, trace thickness and width, air-flow, and proximity of other heat generating components will affect the temperature rise. It is recommended that the temperature of the part not exceed 155°C under worst case operating conditions verified in the end application.

3 I<sub>sat</sub> Amps Peak for approximately 10% rolloff @ 20°C

4 I<sub>sat</sub> Amps Peak for approximately 15% rolloff @ 20°C

5 K-factor: Used to determine B<sub>p-p</sub> for core loss (see graph). B<sub>p-p</sub> = K \* L \* ΔI B<sub>p-p</sub>: (Gauss), K: (K factor from table), L: (Inductance in µH), ΔI (Peak to peak ripple current in Amps).

### Dimensions - mm

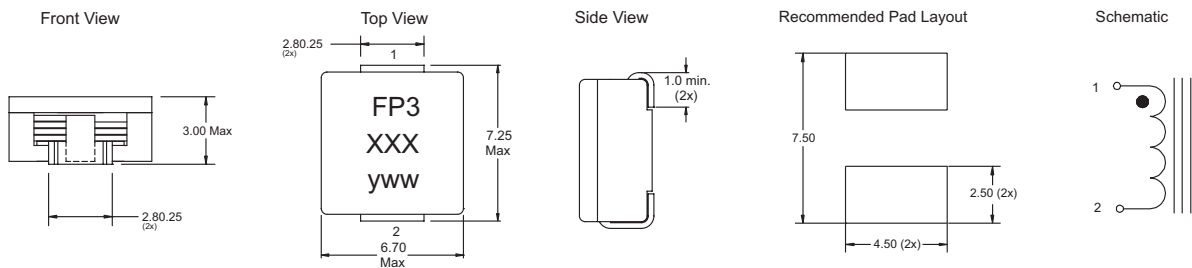

## FLAT-PAC™ FP3 Series

### Packaging Information - mm

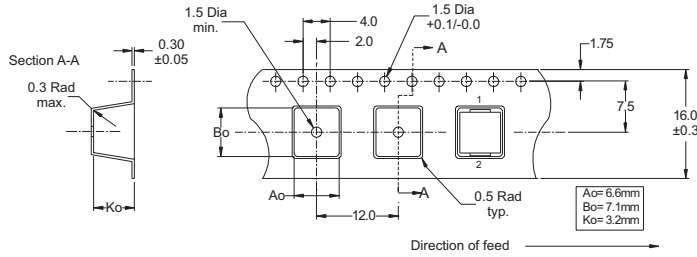

xxx = Inductance value      yyw = Date code

### Temperature Rise vs. Total Loss

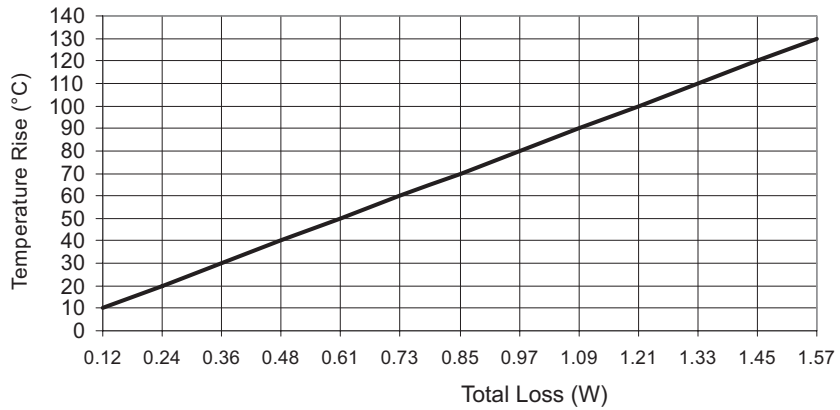

### Core Loss

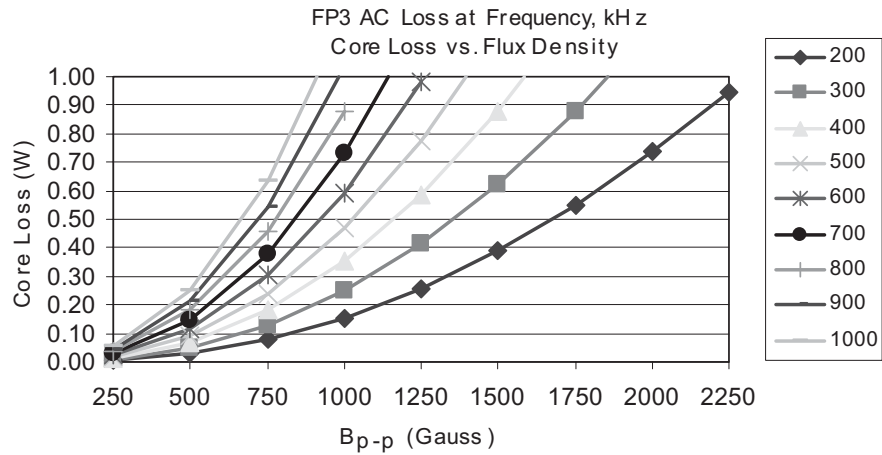

### Inductance Characteristics

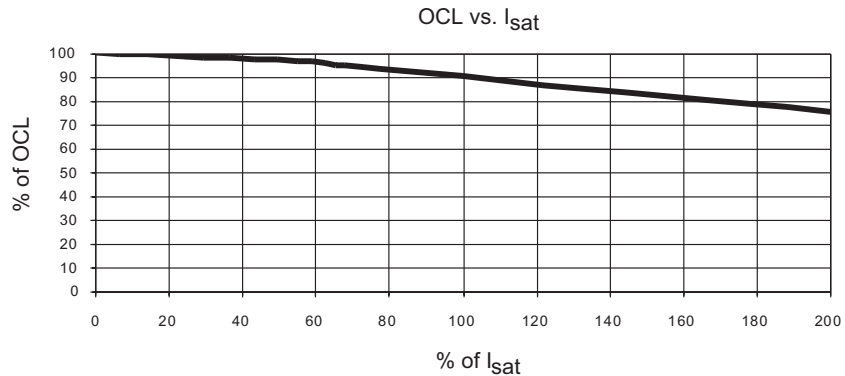

## HCP0704 Series

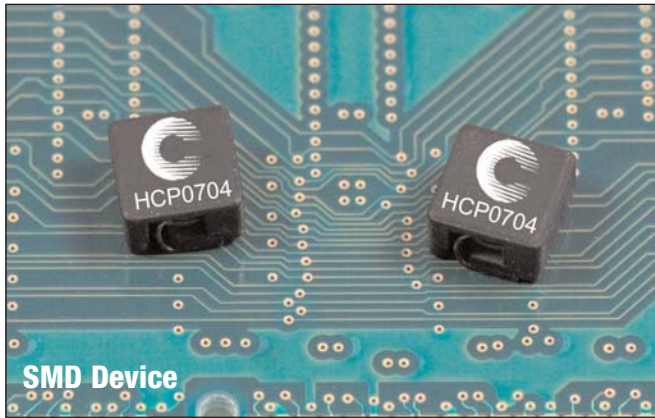

### Description:

- Halogen free
- 155°C maximum total temperature operation
- 6.8 x 6.8 x 4.2mm surface mount package
- Powder iron core material
- Magnetically shielded, low EMI
- High temperature core material eliminates thermal aging issues
- High current carrying capacity, low core losses
- Controlled DCR tolerance for sensing circuits
- Inductance range from 0.40μH to 4.7μH
- Current range from 5.0 to 27 amps
- Frequency range up to 2MHz
- RoHS compliant

### Applications:

- Voltage Regulator Module (VRM)
- Multi-phase regulators
- Desktop and servers
- Base station equipment
- Notebook regulators
- Data networking and storage systems
- Point-of-load modules
- Battery power systems
- DCR sensing



### Environmental Data:

- Storage temperature range: -40°C to +155°C
- Operating temperature range: -40°C to +155°C (Range is application specific)
- Solder reflow temperature: J-STD-020D compliant

### Packaging:

- Supplied in tape-and-reel packaging, 1000 parts per reel, 13" diameter reel

HCP Series

### Product Specifications

Part Number <sup>6</sup>	OCL <sup>1</sup> ± 25% (μH)	FLL <sup>2</sup> Min. (μH)	I <sub>rms</sub> <sup>3</sup> (Amps)	I <sub>sat</sub> <sup>4</sup> @ 25°C (Amps)	DCR (mΩ) @ 20°C	K-factor <sup>5</sup>
HCP0704-R40-R	0.40	0.28	17	27	3.2 ±10%	383.1
HCP0704-R60-R	0.50	0.42	14	21	4.5 ±10%	313.5
HCP0704-1R0-R	1.00	0.7	12	17	6.2 ±10%	265.3
HCP0704-1R8-R	1.80	1.26	8.5	13	11.0 ±10%	202.8
HCP0704-2R3-R	2.30	1.56	7.5	11.5	16.5 ±10%	164.2
HCP0704-3R3-R	3.30	2.31	6.0	9.5	25.0 ±10%	149.9
HCP0704-4R7-R	4.70	3.29	5.0	8.0	29.5 ±10%	127.7

1 Open Circuit Inductance (OCL) Test Parameters: 100kHz, 0.10V<sub>rms</sub>, 0.0Adc

2 Full Load Inductance (FLL) Test Parameters: 100kHz, 0.1V<sub>rms</sub>, I<sub>sat</sub><sup>1</sup>

3 I<sub>rms</sub>: DC current for an approximate temperature rise of 40°C without core loss. Derating is necessary for AC currents. PCB pad layout, trace thickness and width, air-flow and proximity of other heat generating components will affect the temperature rise. It is recommended the part temperature not exceed 125°C under worst case operating conditions verified in the end application.

4 I<sub>sat</sub>: Peak current for approximately 20% rolloff at +25°C.

5 K-factor: Used to determine B<sub>p-p</sub> for core loss (see graph). B<sub>p-p</sub> = K • L • ΔI : (Gauss), K: (K-factor from table), L: (inductance in μH), ΔI (peak-to-peak ripple current in amps).

6 Part Number Definition: HCP0704-xxx-R

- HCP0704 = Product code and size
- xxx= Inductance value in μH, R = decimal point. If no "R" is present, then third character = # of zeros
- "-R" suffix = RoHS compliant

## HCP0704 Series

### Dimensions - mm

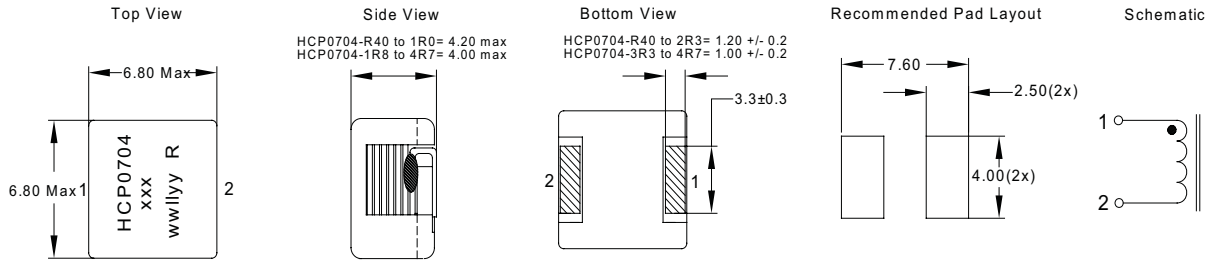

The nominal DCR test point is in the middle of the terminal

Part Marking: HCP0704      xxx = Inductance value in  $\mu\text{H}$ . (R = Decimal point). If no "R" is present, then last character is # of zeros      wwlyy = Date code      R = Revision level

### Packaging Information - mm

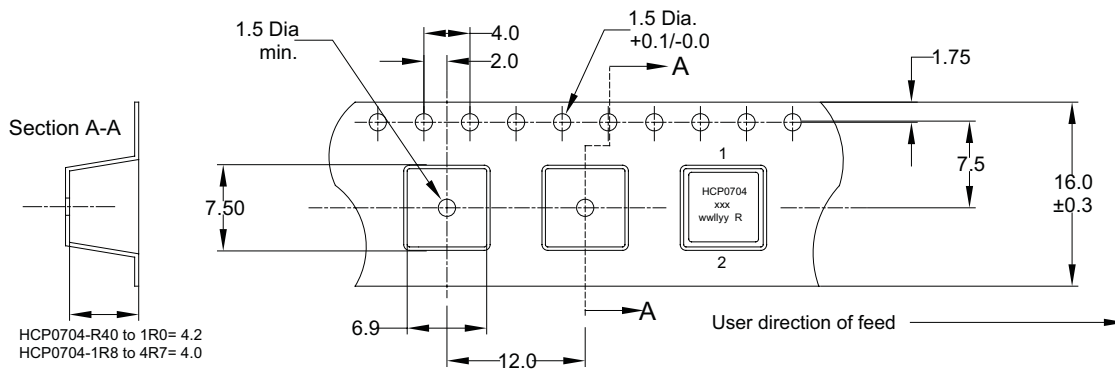

Supplied in tape-and-reel packaging, 1000 parts per reel, 13" diameter reel.

### Temperature Rise vs. Total Loss

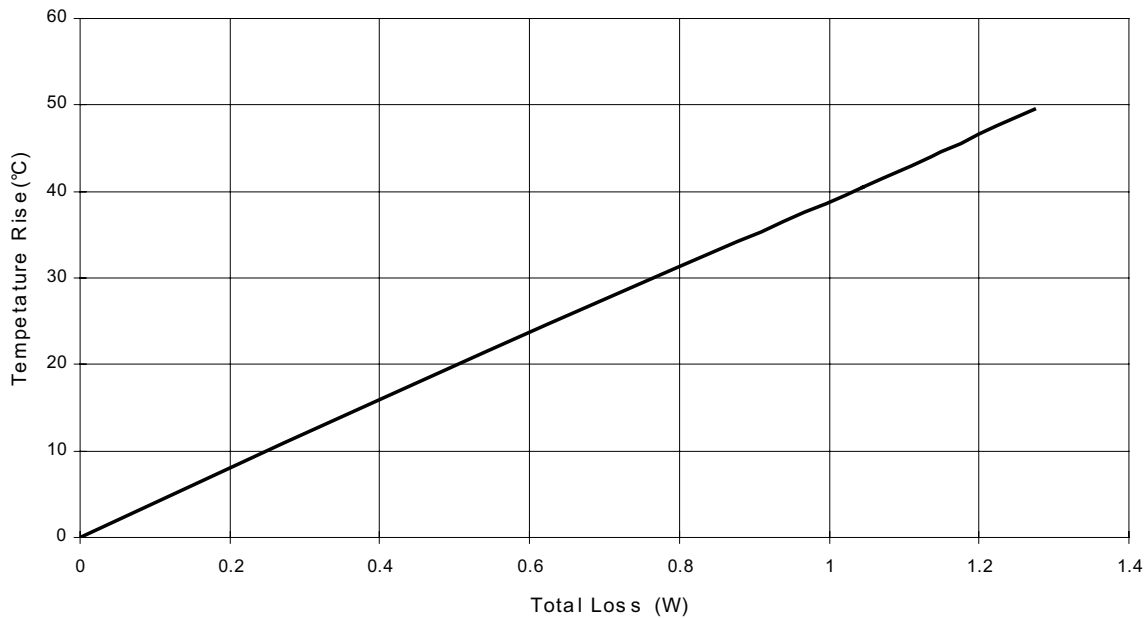



HCP0704 Series

Core Loss

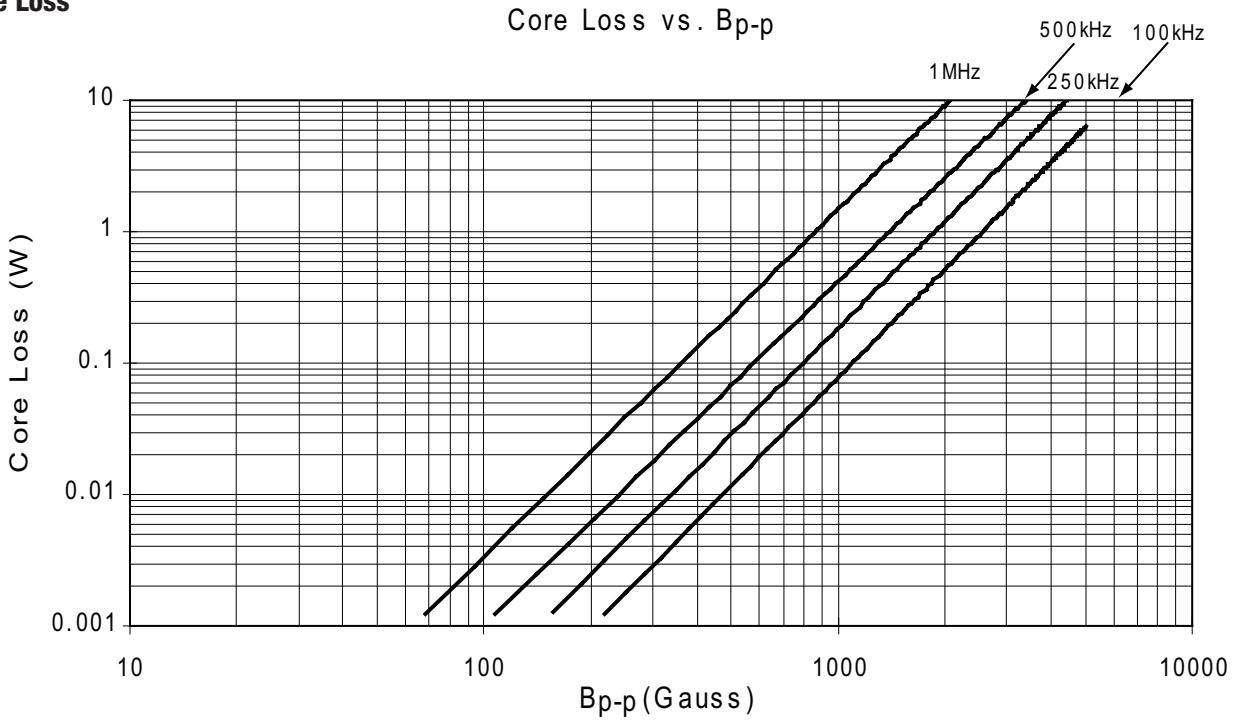

Inductance Characteristics

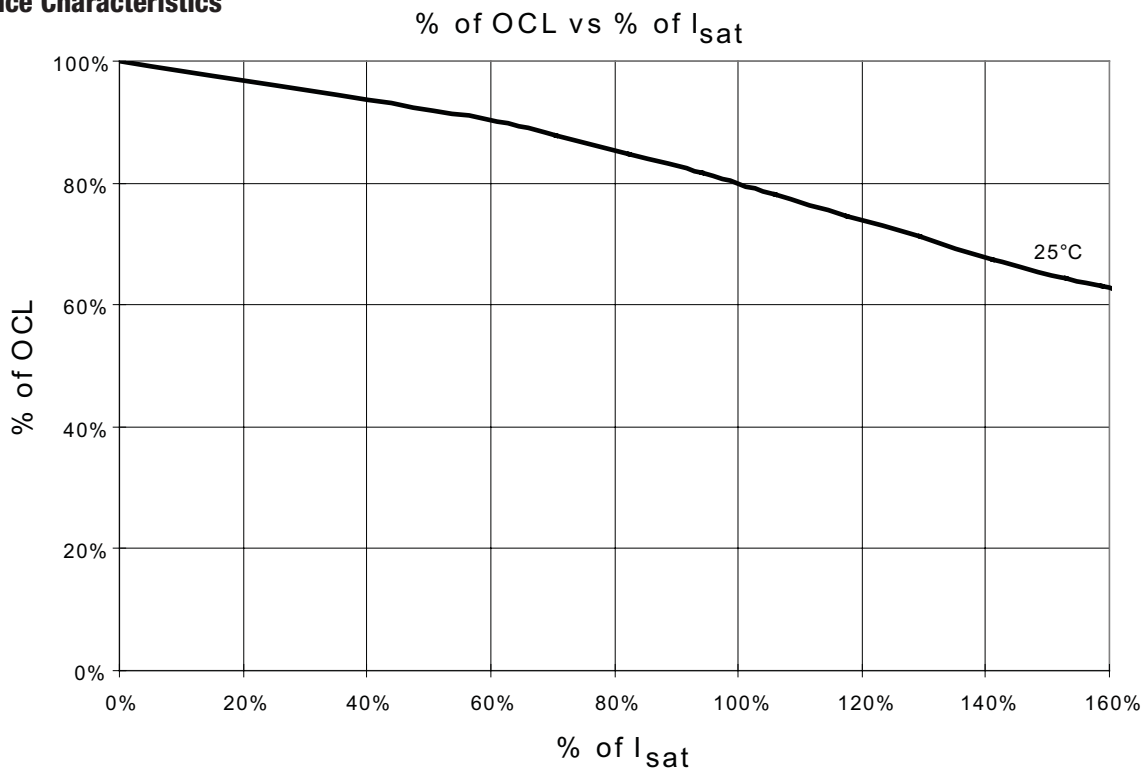

HCP Series

## HCP0805 Series



### Description:

- Halogen free
- 125°C maximum total temperature operation
- 7.6 x 7.9 x 5.0mm surface mount package
- Powder iron core material
- Magnetically shielded, low EMI
- High current carrying capacity, low core losses
- Controlled DCR tolerance for sensing circuits
- Inductance range from 0.40µH to 2.2µH
- Current range from 10.0 to 32 amps
- Frequency range up to 2MHz
- RoHS compliant

### Applications:

- Voltage Regulator Module (VRM)
- Multi-phase regulators
- Desktop and servers
- Base station equipment
- Notebook regulators
- Data networking and storage systems
- Point-of-load modules
- Battery power systems
- DCR sensing

RoHS  
2002/95/EC

### Environmental Data:

- Storage temperature range: -40°C to +125°C
- Operating temperature range: -40°C to +125°C (Range is application specific)
- Solder reflow temperature: J-STD-020D compliant

### Packaging:

- Supplied in tape-and-reel packaging, 700 parts per 13" diameter reel

Product Specifications						
Part Number <sup>6</sup>	OCL <sup>1</sup> ± 20% (µH)	FLL <sup>2</sup> Min. (µH)	I <sub>rms</sub> <sup>3</sup> (Amps)	I <sub>sat</sub> <sup>4</sup> @ 25°C (Amps)	DCR (mΩ) @ 20°C	K-factor <sup>5</sup>
HCP0805-R40-R	0.40	0.26	20	32	3.1 ±6.0%	376.0
HCP0805-R68-R	0.68	0.44	17.5	25	4.5 ±6.0%	292.0
HCP0805-1R0-R	1.00	0.64	14.5	22	5.8 ±6.0%	239.0
HCP0805-1R5-R	1.50	0.96	13.3	18	6.8 ±6.0%	202.0
HCP0805-2R2-R	2.20	1.41	10	14	11.2 ±6.0%	175.0

1 Open Circuit Inductance (OCL) Test Parameters: 100kHz, 0.10V<sub>rms</sub>, 0.0A<sub>dc</sub>

2 Full Load Inductance (FLL) Test Parameters: 100kHz, 0.1V<sub>rms</sub>, I<sub>sat</sub><sup>1</sup>

3 I<sub>rms</sub>: DC current for an approximate temperature rise of 40°C without core loss. Derating is necessary for AC currents. PCB pad layout, trace thickness and width, air-flow and proximity of other heat generating components will affect the temperature rise. It is recommended the part temperature not exceed 125°C under worst case operating conditions verified in the end application.

4 I<sub>sat</sub>: Peak current for approximately 20% rolloff at +25°C.

5 K-factor: Used to determine B<sub>p-p</sub> for core loss (see graph). B<sub>p-p</sub> = K \* L \* ΔI. B<sub>p-p</sub>: (Gauss), K: (K-factor from table), L: (inductance in µH), ΔI (peak-to-peak ripple current in amps).

6 Part Number Definition: HCP0805-xxx-R

- HCP0805 = Product code and size
- xxx= Inductance value in µH, R = decimal point. If no "R" is present, then third character = # of zeros.
- "-R" suffix = RoHS compliant

## HCP0805 Series

### Dimensions - mm

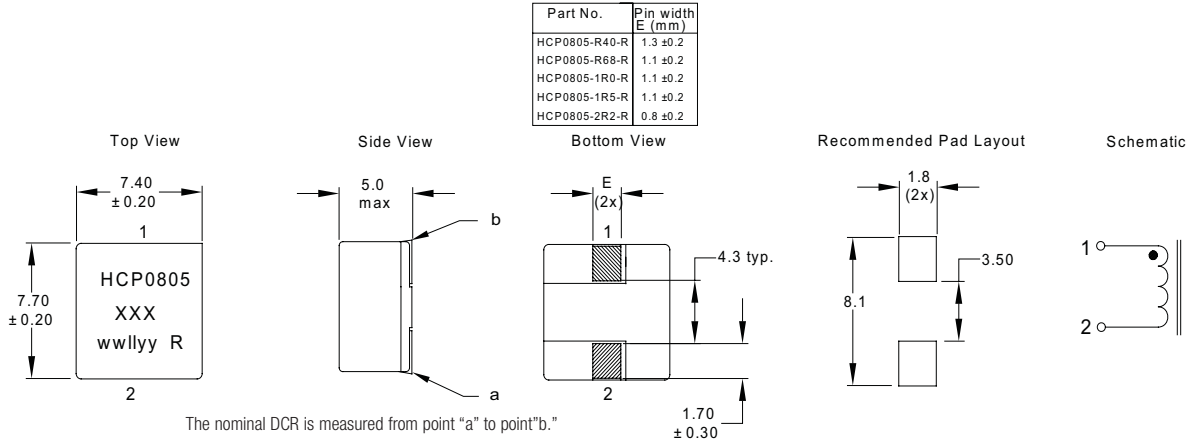

Part Marking: HCP0805      xxx = Inductance value in  $\mu\text{H}$ . (R = Decimal point). If no "R" is present, then last character is # of zeros      wwlllyy = Date code      R = Revision level

### Packaging Information - mm

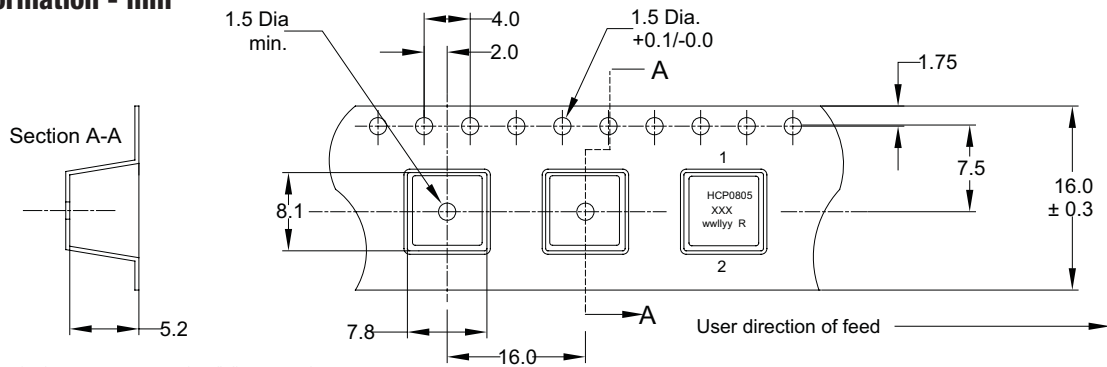

Supplied in tape-and-reel packaging, 700 parts per reel, 13" diameter reel.

### Temperature Rise vs. Total Loss

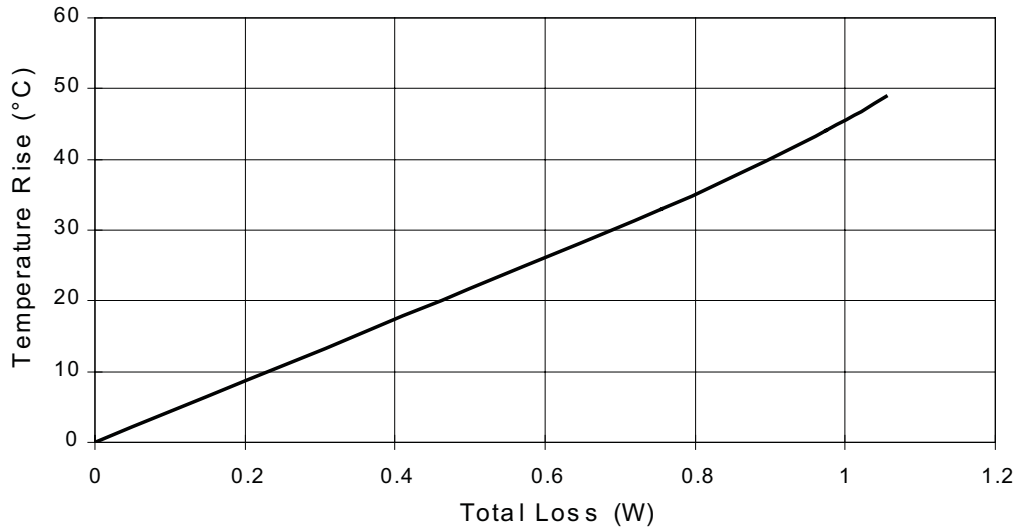

HCP0805 Series

Core Loss

Core Loss vs.  $B_{p-p}$

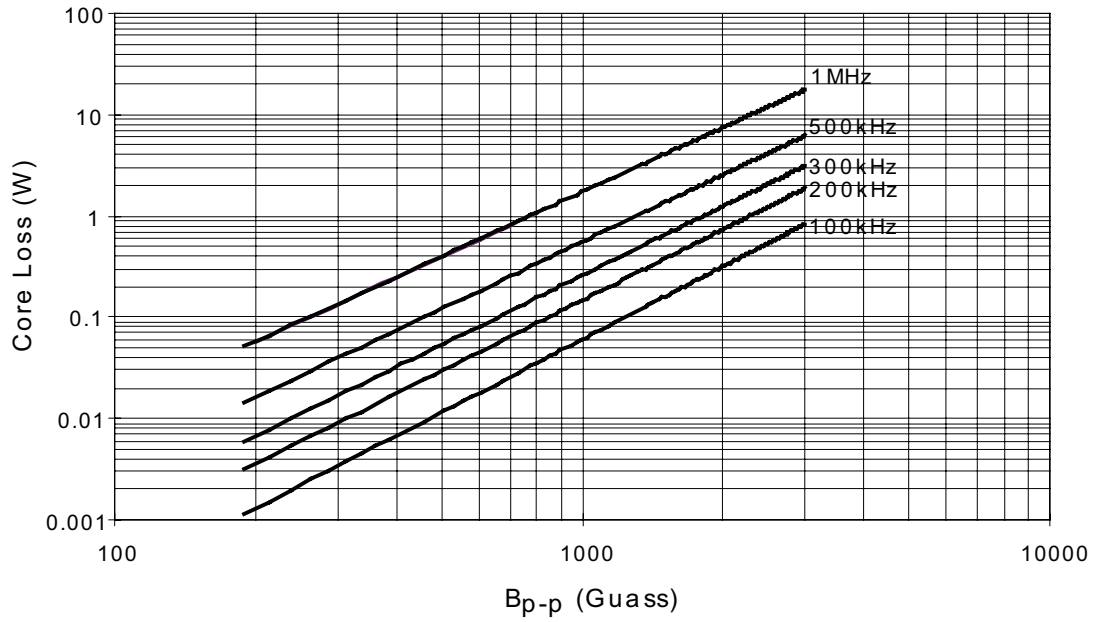

Inductance Characteristics

% of OCL vs. % of  $I_{sat}$

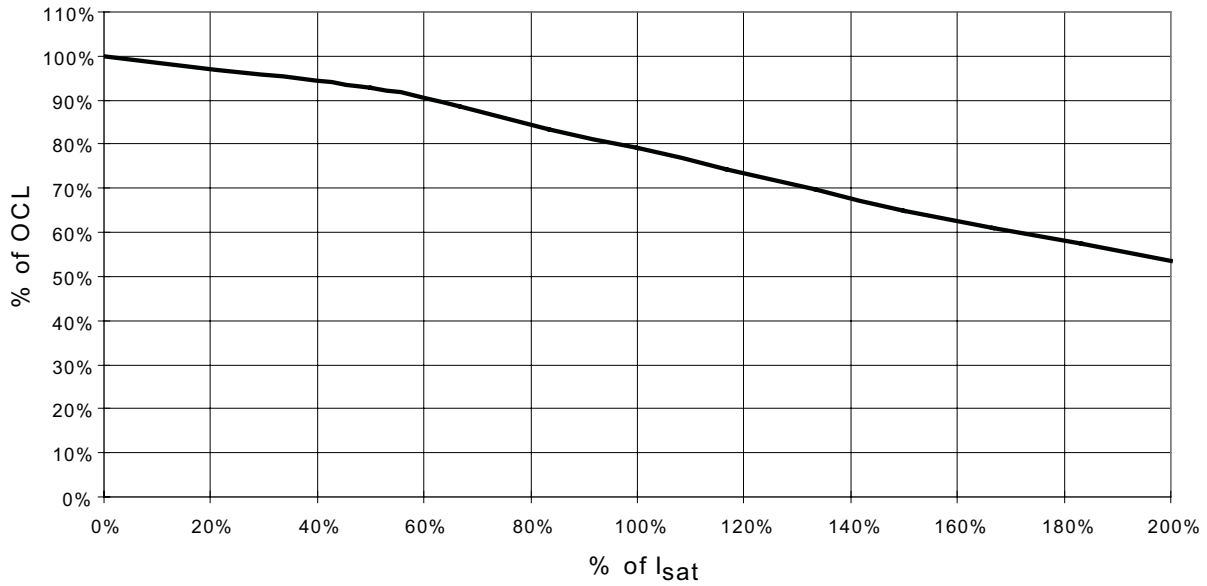

Solder Reflow Profile for FLAT-PAC™ FP Series and HCP Series Inductors

Solder Reflow Profile

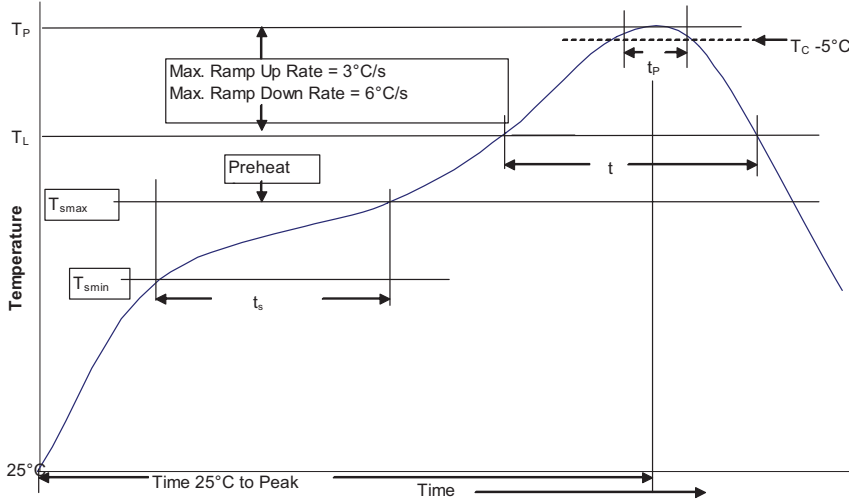

Table 1 - Standard SnPb Solder ( $T_c$ )

Package Thickness	Volume $<350$ mm <sup>3</sup>	Volume $\geq 350$ mm <sup>3</sup>
$<2.5$ mm	235°C	220°C
$\geq 2.5$ mm	220°C	220°C

Table 2 - Lead (Pb) Free Solder ( $T_c$ )

Package Thickness	Volume $<350$ mm <sup>3</sup>	Volume 350 - 2000 mm <sup>3</sup>	Volume $>2000$ mm <sup>3</sup>
$<1.6$ mm	260°C	260°C	260°C
1.6 - 2.5mm	260°C	250°C	245°C
$>2.5$ mm	250°C	245°C	245°C

Reference JDEC J-STD-020D

Profile Feature	Standard SnPb Solder	Lead (Pb) Free Solder
Preheat and Soak	<ul style="list-style-type: none"> <li>Temperature min. (<math>T_{smin}</math>)</li> <li>Temperature max. (<math>T_{smax}</math>)</li> <li>Time (<math>T_{smin}</math> to <math>T_{smax}</math>) (<math>t_s</math>)</li> </ul>	<ul style="list-style-type: none"> <li>150°C</li> <li>200°C</li> <li>60-120 Seconds</li> </ul>
Average ramp up rate $T_{smax}$ to $T_p$	3°C/ Second Max.	3°C/ Second Max.
Liquidous temperature ( $T_L$ )	183°C	217°C
Time at liquidous ( $t_L$ )	60-150 Seconds	60-150 Seconds
Peak package body temperature ( $T_p$ )*	Table 1	Table 2
Time ( $t_p$ )** within 5 °C of the specified classification temperature ( $T_c$ )	20 Seconds**	30 Seconds**
Average ramp-down rate ( $T_p$ to $T_{smax}$ )	6°C/ Second Max.	6°C/ Second Max.
Time 25°C to Peak Temperature	6 Minutes Max.	8 Minutes Max.

\* Tolerance for peak profile temperature ( $T_p$ ) is defined as a supplier minimum and a user maximum.

\*\* Tolerance for time at peak profile temperature ( $t_p$ ) is defined as a supplier minimum and a user maximum.

## High Frequency Inductors for Core Power Applications

The trend in modern power conversion is for high power density, reduced volume and increased efficiency. The drive for smaller, more efficient solutions presents a number of challenges for circuit design and component selection.

Inductor selection in high current core power applications is based on a need for high peak current ratings and low high frequency losses. These two requirements lead designers in different directions resulting in a compromise solution. Designers are forced to select low inductance values to reduce inductor size (and ensure fast transient responses which results in high ripple currents needing to be absorbed by the inductor increasing losses) or select higher inductance values to reduce the ripple current and losses - but at a sacrifice of inductor size, efficiency and transient responses.

The material of choice for core power multi-phase uncoupled inductors is ferrite. Core power applications require a high saturation, high frequency, low loss, wide temperature range ferrite material to be selected. The reduced core loss at high frequency (coupled with a very low Direct Current Resistance - DCR - single turn rectangular conductor) ensures high efficiency (see Figure 1).

**Figure 1 -Typical Three-Phase Voltage Regulator Module (VRM)**

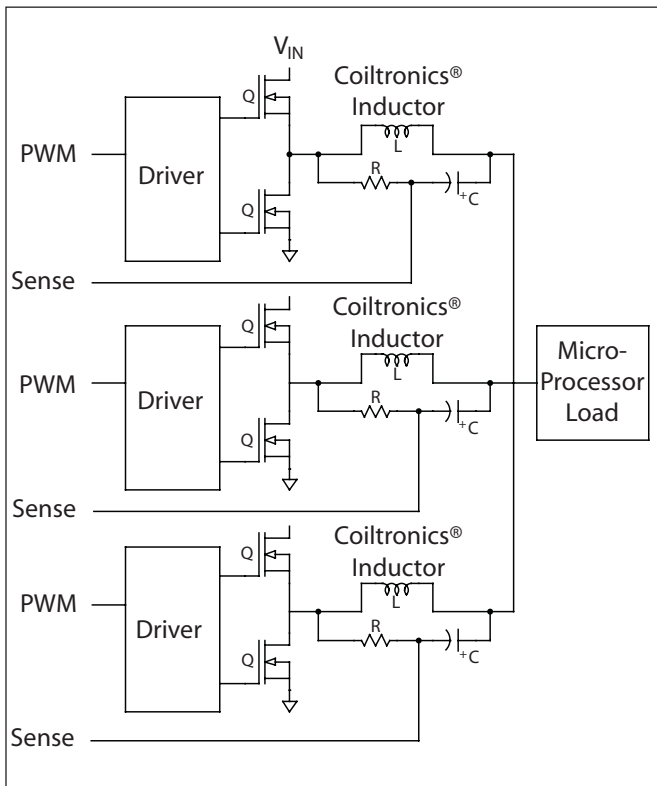

### Current Sensing

When accurate current sensing is required, a low value resistor is commonly used to generate a voltage proportional to the output current. The introduction of such a current sense resistor increases the circuit losses along with overall converter size and cost. Using an output inductor with a tight DCR tolerance will eliminate the need for the current sense resistor.

**Figure 2 – Inductor Current Sensing Circuit**

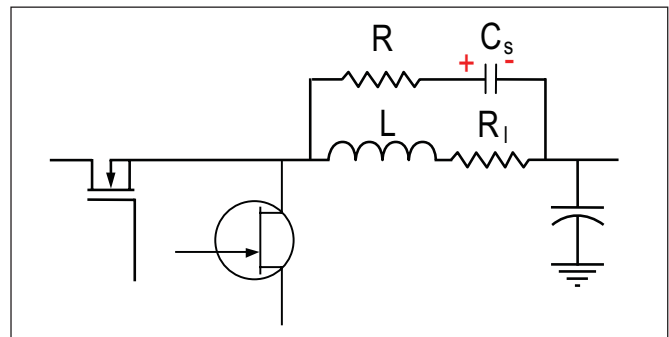

Figure 2 shows a typical inductor current sense circuit, where the voltage across  $C_s$  is equal to the volt drop across the inductor DCR when the RC time constant is equal to the inductor time constant ( $R \cdot C = L/R_i$ ). The low DC resistance at tight tolerance enables the inductor to also function as a current sensor (DCR Sensing). The Cooper Bussmann Coiltronics® Flat-Pac™ Series of inductors offers the largest variety of sizes, ratings, DCR options, and stands out as the industry leader in multi-phase uncoupled core power applications.

Comparing the performance of traditional ferrite inductors (such as the FP2 with the new DCR current sense inductors from Cooper Bussmann) it can be seen that the benefits go beyond the elimination of sensing resistors.

## High Frequency Inductors for Core Power Applications

From Table 1 it can be seen that in addition to offering three different DCR values and tolerances the FP0705 has better performance over the traditional FP2 inductor. The FP0705 also has greater core loss stability over a wide temperature range, which is a consideration that is often overlooked during converter design. Almost all inductor specifications show room temperature values. However, the effects of increased temperature need to be accounted for as peak current ratings are reduced and losses increased at elevated temperatures.

The Cooper Bussmann Coiltronics® Flat-Pac™ Series of DCR current sensing inductors is available in footprints of 7 x 7mm, 7 x 8mm, 10 x 7mm,

10 x 8mm and 11 x 8mm with many inductance value ranges and DCR tolerances. All parts exhibit low DCR, high peak current ratings and very low high frequency core losses that remain stable over a wide temperature range. The Flat-Pac™ inductors are also RoHS compliant and Halogen Free. The combination of these characteristics make the new Flat-Pac™ inductors ideal for high frequency, high efficiency voltage regulation modules used in computer core power applications.

See Table 2 for a detail reference of the new core power inductor solutions available from Cooper Bussmann.

**Table 1 – DCR Current Sense Inductor Performance**

Coiltronics Part No.	Core Material	Nominal Inductance	I <sub>rms</sub> (A) <sup>1</sup>	I <sub>pk</sub> (A) <sup>2</sup>	DCR (mΩ)	Core Loss (mW) <sup>3</sup>	Height (mm)
FP2-V150-R	Ferrite	150nH	37	23	0.28	50	5
FP0705R1-R15-R	Ferrite	150nH	43	30	0.25 ± 10%	10	5
FP0705R2-R15-R	Ferrite	150nH	38	30	0.32 ± 9.4%	10	5
FP0705R3-R15-R	Ferrite	150nH	32	30	0.46 ± 6.5%	10	5

1. DC current for an approximate ΔT of 40°C  
 2. Peak current for approximately 20% roll off at 25°C  
 3. Losses at 500kHz, applied volt-second of 0.75V-μs



**Table 2 - High Frequency Inductor Selection Matrix**

Inductor Series	Coiltronics Part Number	Dimension (mm)	OCL (nH)	I <sub>sat</sub> (A)@		I <sub>rms</sub> (A) xx <sup>1</sup> =			DCR(mΩ) xx <sup>1</sup> =		
				25°C	125°C	R1	R2	R3	R1	R2	R3
FP0705	FP0705xx-R07-R	7 x 7 x 4.95	72	65	50	43	38	32	0.25±10%	0.32±9.4%	0.46±6.5%
	FP0705xx-R10-R	7 x 7 x 4.95	105	44	36	43	38	32	0.25±10%	0.32±9.4%	0.46±6.5%
	FP0705xx-R12-R	7 x 7 x 4.95	120	37	30	43	38	32	0.25±10%	0.32±9.4%	0.46±6.5%
	FP0705xx-R15-R	7 x 7 x 4.95	150	30	24	43	38	32	0.25±10%	0.32±9.4%	0.46±6.5%
	FP0705xx-R18-R	7 x 7 x 4.95	180	25	20	43	38	32	0.25±10%	0.32±9.4%	0.46±6.5%
FP0705xx-R22-R	7 x 7 x 4.95	220	20	16	43	38	32	0.25±10%	0.32±9.4%	0.46±6.5%	
FP0708	FP0708xx-R07-R	8.5 x 7.0 x 7.2	72	90	72	44	-	-	0.35±8.6%	-	-
	FP0708xx-R09-R	8.5 x 7.0 x 7.2	90	75	60	44	-	-	0.35±8.6%	-	-
	FP0708xx-R10-R	8.5 x 7.0 x 7.2	105	68	54	44	-	-	0.35±8.6%	-	-
	FP0708xx-R12-R	8.5 x 7.0 x 7.2	120	59	47	44	-	-	0.35±8.6%	-	-
	FP0708xx-R15-R	8.5 x 7.0 x 7.2	150	47	37	44	-	-	0.35±8.6%	-	-
FP0708xx-R19-R	8.5 x 7.0 x 7.2	190	37	29	44	-	-	0.35±8.6%	-	-	
FP0805	FP0805xx-R03-R	7.49 x 7.62 x 4.96	32	110	95	65	-	-	0.17±17%	-	-
	FP0805xx-R06-R	7.49 x 7.62 x 4.96	58	83	61	65	-	-	0.17±17%	-	-
	FP0805xx-R07-R	7.49 x 7.62 x 4.96	72	67	49	65	-	-	0.17±17%	-	-
	FP0805xx-R10-R	7.49 x 7.62 x 4.96	100	50	35	65	-	-	0.17±17%	-	-
	FP0805xx-R20-R	7.49 x 7.62 x 4.96	200	20	16	65	-	-	0.17±17%	-	-
FP0807	FP0807xx-R07-R	7.4 x 7.6 x 7.0	70	108	79	49	-	-	0.50±6%	-	-
	FP0807xx-R10-R	7.4 x 7.6 x 7.0	100	77	55	49	-	-	0.50±6%	-	-
	FP0807xx-R12-R	7.4 x 7.6 x 7.0	120	66	48	49	-	-	0.50±6%	-	-
	FP0807xx-R16-R	7.4 x 7.6 x 7.0	160	48	36	49	-	-	0.50±6%	-	-
	FP0807xx-R18-R	7.4 x 7.6 x 7.0	180	42	32	49	-	-	0.50±6%	-	-
	FP0807xx-R20-R	7.4 x 7.6 x 7.0	200	38	28	49	-	-	0.50±6%	-	-
FP0807xx-R22-R	7.4 x 7.6 x 7.0	220	35	25	49	-	-	0.50±6%	-	-	

1. DCR Indicator.

## High Frequency Inductors for Core Power Applications

**Table 2 - High Frequency Inductor Selection Matrix** (Continued)

Inductor Series	Coiltronics Part Number	Dimension (mm)	OCL (nH)	I <sub>sat</sub> (A)@		I <sub>rms</sub> (A) xx' =			DCR(mΩ) xx' =		
				25°C	125°C	R1	R2	R3	R1	R2	R3
FP1105	FP0705xx-R07-R	7 x 7 x 4.95	72	65	50	43	38	32	0.25±10%	0.32±9.4%	0.46±6.5%
	FP1105xx-R10-R	8 x 11 x 4.9	100	81	63	46	-	-	0.35 ± 8.6%	-	-
	FP1105xx-R12-R	8 x 11 x 4.9	120	66	50	46	-	-	0.35 ± 8.6%	-	-
	FP1105xx-R15-R	8 x 11 x 4.9	150	54	42	46	-	-	0.35 ± 8.6%	-	-
	FP1105xx-R20-R	8 x 11 x 4.9	192	42	34	46	-	-	0.35 ± 8.6%	-	-
	FP1105xx-R22-R	8 x 11 x 4.9	226	39	28	46	-	-	0.35 ± 8.6%	-	-
FP1107	FP1107xx-R07-R	7.2 x 11 x 7.2	70	140	123	55	42	-	0.29 ± 10.0%	0.47 ± 6.4%	-
	FP1107xx-R12-R	7.2 x 11 x 7.2	120	90	72	55	42	-	0.29 ± 10.0%	0.47 ± 6.4%	-
	FP1107xx-R15-R	7.2 x 11 x 7.2	150	70	56	55	42	-	0.29 ± 10.0%	0.47 ± 6.4%	-
	FP1107xx-R23-R	7.2 x 11 x 7.2	230	45	36	55	42	-	0.29 ± 10.0%	0.47 ± 6.4%	-
	FP1107xx-R30-R	7.2 x 11 x 7.2	300	35	28	55	42	-	0.29 ± 10.0%	0.47 ± 6.4%	-
	FP1107xx-R40-R	7.2 x 11 x 7.2	400	25	20	55	42	-	0.29 ± 10.0%	0.47 ± 6.4%	-
FP1005	FP1107xx-R51-R	7.2 x 11 x 7.2	510	18	14.5	55	42	-	0.29 ± 10.0%	0.47 ± 6.4%	-
	FP1005xx-R08-R	7 x 10.2 x 4.95	85	90	64	53	50	45	0.39±7.7%	0.47±6.7%	0.55±5.4%
	FP1005xx-R10-R	7 x 10.2 x 4.95	100	73	57	53	50	45	0.39±7.7%	0.47±6.7%	0.55±5.4%
	FP1005xx-R12-R	7 x 10.2 x 4.95	120	60	48	53	50	45	0.39±7.7%	0.47±6.7%	0.55±5.4%
	FP1005xx-R15-R	7 x 10.2 x 4.95	150	47	37	53	50	45	0.39±7.7%	0.47±6.7%	0.55±5.4%
FP1006	FP1005xx-R22-R	7 x 10.2 x 4.95	220	33	26	53	50	45	0.39±7.7%	0.47±6.7%	0.55±5.4%
	FP1006xx-R08-R	8 x 10.2 x 6	85	100	70	53	45	-	0.27 ± 12%	0.36 ± 8.6%	-
	FP1006xx-R10-R	8 x 10.2 x 6	100	85	64	53	45	-	0.27 ± 12%	0.36 ± 8.6%	-
	FP1006xx-R12-R	8 x 10.2 x 6	120	71	53	53	45	-	0.27 ± 12%	0.36 ± 8.6%	-
	FP1006xx-R16-R	8 x 10.2 x 6	160	55	40	53	45	-	0.27 ± 12%	0.36 ± 8.6%	-
FP1007	FP1006xx-R22-R	8 x 10.2 x 6	220	38	28	53	45	-	0.27 ± 12%	0.36 ± 8.6%	-
	FP1007xx-R12-R	10.41 x 8 x 7.0	120	81	65	60	51	-	0.29 ±10%	0.48 ±8%	-
	FP1007xx-R14-R	10.41 x 8 x 7.0	140	72	56	60	51	-	0.29 ±10%	0.48 ±8%	-
	FP1007xx-R17-R	10.41 x 8 x 7.0	170	58	46	60	51	-	0.29 ±10%	0.48 ±8%	-
	FP1007xx-R22-R	10.41 x 8 x 7.0	215	50	36	60	51	-	0.29 ±10%	0.48 ±8%	-
	FP1007xx-R30-R	10.41 x 8 x 7.0	300	32	26	60	51	-	0.29 ±10%	0.48 ±8%	-

1. DCR Indicator.



## Power Inductors Improve Reliability in High Temperature Designs

Cooper Bussmann Coiltronics® high current FP3™ power inductors are designed for high density, medium current applications using a high temperature iron powder core material. These inductors do not exhibit the thermal aging issue frequently associated with iron powder core inductors. In fact the FP3 core is rated for 200°C without thermal degradation. The FP3 family is rated for 155°C operation. The calculations below will allow users to take advantage of this high temperature capability.

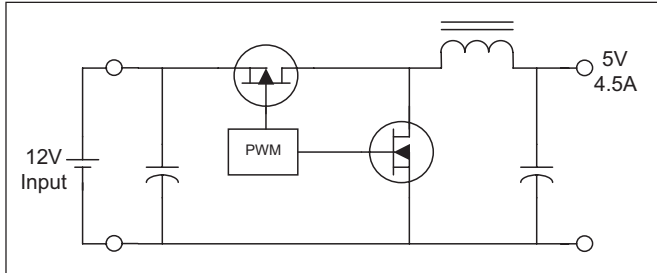

In this example, a buck regulator will be used to convert a 12V input to a 5V output with a load current of 4.5A. The operating frequency was chosen to be 600 kHz to reduce the size of the filter components, while still maintaining good efficiency. The converter is designed to have 20% ripple current, so a relatively low ESR output filter capacitor will be used, as is typical in switching power supplies.

**First calculate the needed inductance value  $V = L * di/dt$  where:**

$$V = V_{in} - V_{out} \text{ (voltage across the inductor)}$$

$$dt = \text{On time of drive} = V_{out}/V_{in}/\text{frequency}$$

$$\Delta I = \text{Chosen above to be 20\%}$$

**Calculate the required inductance:**

$$L = V * dt / \Delta I = (12-5) * (12/5/600k) / (0.2 * 4.5)$$

$$L = 4.8 \mu\text{H}$$

**Choose 4.7  $\mu\text{H}$ , the nearest standard value.**

**Recalculate ripple current at 23% using 4.7  $\mu\text{H}$ .**

**Second determine peak to peak flux density,  $B_{p-p}$ :**

$$B_{p-p} = K * L * \Delta I \text{ where:}$$

K: K-factor from the adjacent table

L: Inductance  $\mu\text{H}$

$\Delta I$ : Peak to peak ripple current (Amps)

$$B_{p-p} = 105 * 4.7 * 0.23 * 4.5 = 510 \text{ Gauss}$$

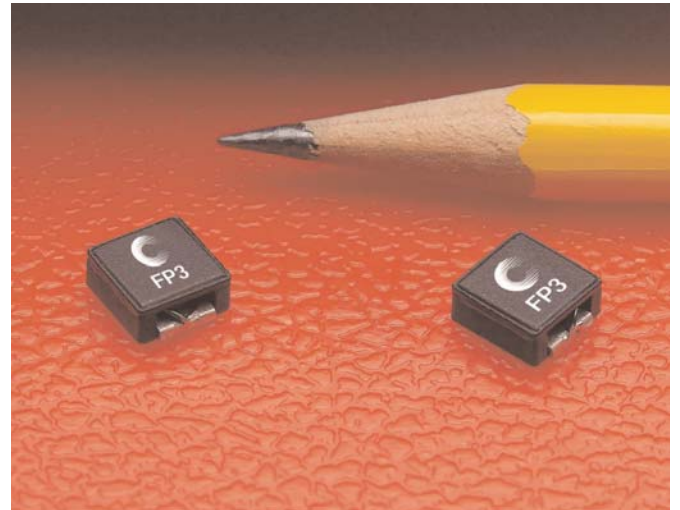

**Next determine the total losses in the inductor:**

$$\text{Total losses} = \text{DC loss} + \text{AC loss}$$

$$\text{DC loss} = I^2 * \text{DCR} = 4.5^2 * 0.040 = 0.81 \text{ W}$$

(DCR from FP3 data sheet)

$$\text{AC loss from table at } B_{p-p} \text{ of } 510 = 0.15 \text{ W}$$

$$\text{Total Loss} = \text{DC loss} + \text{AC loss} = 0.96 \text{ W}$$

**Finally determine the temperature rise.**

- Total loss = 0.96W, using the table,
- Temperature rise is 80°C
- Assuming an ambient temperature of 70°C,

**The temperature of the inductor is  $T = 70 + 75 = 150^\circ\text{C}$**

Part Number	K-factor	Part Number	K-factor
FP3-R10-R	803	FP3-2R0-R	161
FP3-R20-R	482	FP3-3R3-R	127
FP3-R47-R	344	FP3-4R7-R	105
FP3-R68-R	268	FP3-8R2-R	78
FP3-1R0-R	219	FP3-150-R	59
FP3-1R5-R	185		

## Power Inductors Improve Reliability in High Temperature Designs

**Note:** The data assumes no cooling airflow. Cooling will reduce the temperature of the inductor.

**The FP3 is rated for 155°C operation.**

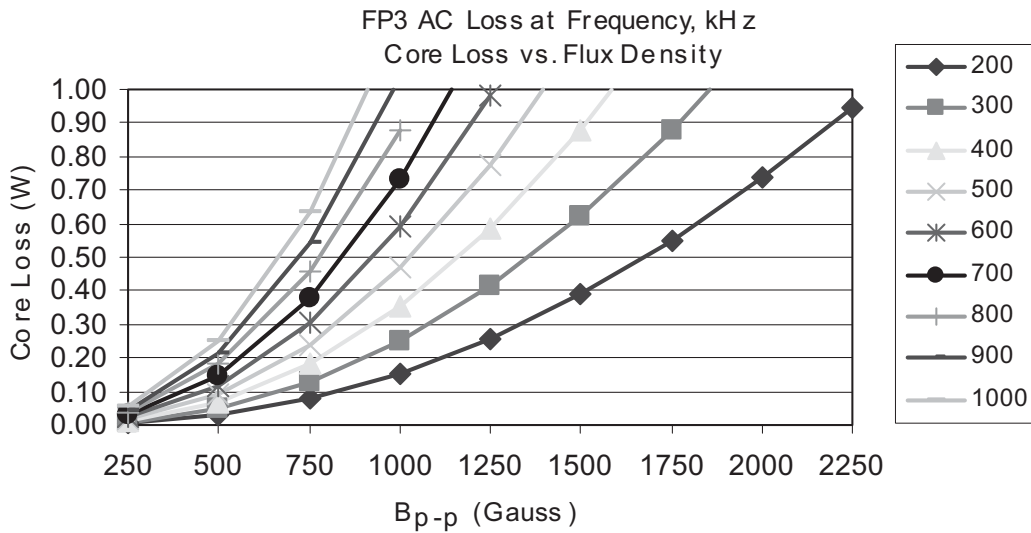

## Temperature Rise vs. Total Loss

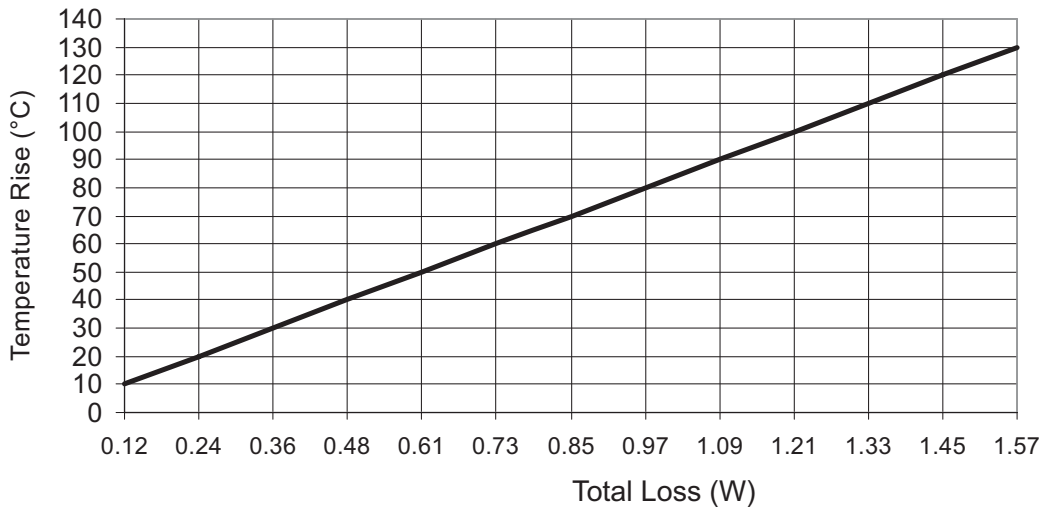

## Inductor Selection for Switching Regulators

### Introduction/Basic Operation

In switching regulator applications the inductor is used as an energy storage device. When the semiconductor switch is ON, the current in the inductor ramps up and energy is stored. When the switch turns OFF, energy is released into the load. The amount of energy stored is calculated by the formula  $Energy = \frac{1}{2}LI^2$  (Joules), where:

- L is the inductance in Henrys
- I is the peak value of inductor current

The amount by which the current changes during a switching cycle is known as the ripple current. Ripple current is defined as  $\Delta I = L \cdot di/dt$ :

- $V_L$  is the voltage across the inductor
- $di$  is the ripple current
- $dt$  is the duration for which the voltage is applied

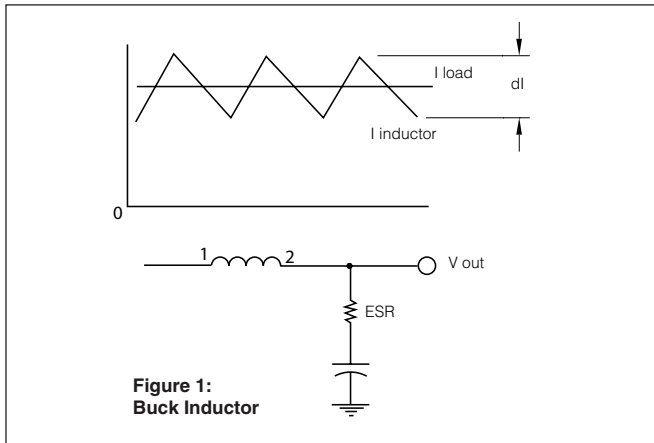

Inductor current is made up of AC and DC components (Figure 1). The AC component is high frequency and will flow through the output capacitor because it has a low HF impedance. A ripple voltage is produced due to the capacitor *Equivalent Series Resistance* (ESR) that will appear at the output of the switching regulator. This ripple voltage needs to be sufficiently low as not to effect the operation of the circuit the regulator is supplying, normally in the order of 10-500mV<sub>pk-pk</sub>.

Selecting the correct ripple current impacts the size of the inductor and output capacitor. The capacitor needs to have a sufficiently high ripple current rating or it will overheat and dry out. To achieve a good compromise between inductor and capacitor size a ripple current value of 10-30% of maximum inductor current should be chosen. The current in the inductor will be continuous for output currents greater than 5-15% of full load.

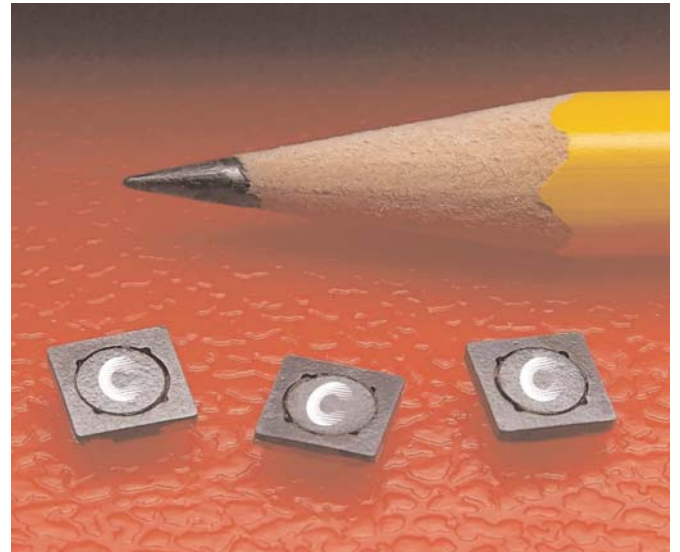

The following parameters need to be defined or calculated to select an inductor:

- Maximum input voltage
- Output voltage
- Switching frequency
- Maximum ripple current
- Duty cycle



**SD3814**

## Inductor Selection for Switching Regulators

### Inductor Selection: Buck Converters

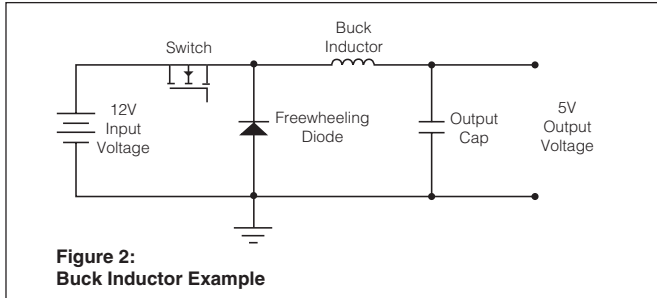

**Figure 2 Application Parameters:**

- Switching frequency= 250kHz
- Input voltage range= 12V±10%
- Max ripple current = 220mA
- Output Voltage= 5.0V

**Step 1. Calculate the duty cycle**

- $V_o$  = output voltage
- $V_i$  = Max input voltage
- $D = V_o / V_i$
- $D = 5/13.2 = 0.379$

**Step 2. Calculate the voltage across the inductance**

- $V_L = V_i - V_o$  (Switch on)
- $V_L = 13.2 - 5 = 8.2V$
- $V_L = -V_o$  (Switch off)
- $V_L = -5V$

**Step 3. Calculate the required inductance**

- $L = V_L \cdot dt/di$
- $L = (8.2 \times 0.379 / 250 \times 10^3) / 0.22$
- $L = 56\mu H$

### Inductor Selection: Boost Converters

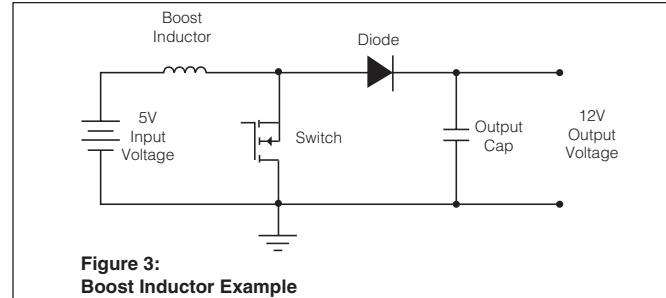

**Figure 3 Application Parameters:**

- Switching frequency= 100kHz
- Input voltage range= 4.5-5.5V
- Max ripple current = 100mA
- Output Voltage= 12.0V

**Step 1. Calculate the duty cycle:**

- $V_o$  = output voltage
- $V_i$  = Max input voltage
- $D = 1 - (V_i / V_o)$
- $D = 1 - (5.5/12.0) = 0.542$

**Step 2. Calculating the voltage across the inductance**

- $V_L = V_i$  (Switch on)
- $V_L = 5.5V$
- $V_L = V_o - V_i$  (Switch off)
- $V_L = 12 - 5.5 = 6.5V$

**Step 3. Calculating the required inductance**

- $L = V_L \cdot dt/di$
- $L = (5.5 \times 0.542 / 100 \times 10^3) / 0.1$
- $L = 298\mu H$

**Typical Applications Using Inductors for Switching Regulators**

Media Players

Digital Cameras

Laptop Computers

Backlight Displays

Industrial Test Equipment

Mobile Phones

## Inductor Selection for Switching Regulators

SDH3812							
Part Number	Rated Inductance (μH)	OCL μH ± 20%	Part Marking Designator	I <sub>rms</sub> Amps	I <sub>sat</sub> Amps	DCR Ω@20°C (Typical)	DCR Ω@20°C (Maximum)
SDH3812-1R0-R	1.0	0.89	B	2.07	3.00	0.045	0.054
SDH3812-1R5-R	1.5	1.49	D	1.67	2.30	0.069	0.083
SDH3812-2R2-R	2.2	2.23	E	1.37	1.90	0.104	0.124
SDH3812-3R3-R	3.3	3.17	F	1.14	1.60	0.148	0.177
SDH3812-4R7-R	4.7	4.96	G	0.94	1.25	0.220	0.264
SDH3812-100-R	10.0	9.67	J	0.69	0.88	0.398	0.478
SDH3812-220-R	22.0	22.00	L	0.50	0.61	0.750	0.900
SDH3812-330-R	33.0	32.90	M	0.41	0.49	1.132	1.358
SDH3812-470-R	47.0	46.20	N	0.34	0.41	1.583	1.900
SDH3812-101-R	100.0	97.50	Q	0.25	0.28	3.042	3.650
SDH3812-221-R	220.0	218.50	S	0.16	0.19	7.017	8.420



**Note:** For full product information and a listing of all available inductor values, see <http://www.cooperbussmann.com/datasheets/elx>, Data Sheet number SDH3812 Series.

### SDH3812 Dimensions - mm

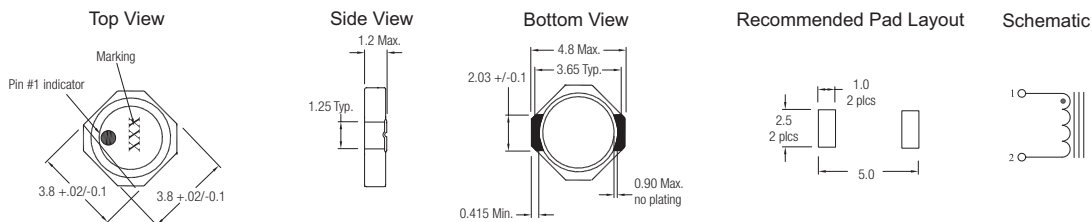

SD3814						
Part Number	Rated Inductance (μH)	OCL μH ± 15%	Part Marking Designator	I <sub>rms</sub> Amps	I <sub>sat</sub> Amps	DCR Ω Typical
SD3814-1R2-R	1.2	1.001	C	1.85	2.67	0.046
SD3814-1R5-R	1.5	1.286	D	1.76	2.35	0.051
SD3814-2R2-R	2.2	1.962	E	1.43	1.90	0.077
SD3814-3R3-R	3.3	2.781	F	1.31	1.60	0.093
SD3814-4R7-R	4.7	4.276	G	1.06	1.29	0.141
SD3814-100-R	10.0	9.830	J	0.713	0.851	0.311
SD3814-220-R	22.0	21.186	L	0.519	0.580	0.589
SD3814-330-R	33.0	32.151	M	0.418	0.471	0.908
SD3814-470-R	47.0	47.210	N	0.346	0.388	1.322



**Note:** For full product information and a listing of all available inductor values, see <http://www.cooperbussmann.com/datasheets/elx>, Data Sheet number SD38 Series.

### SD3814 Dimensions - mm

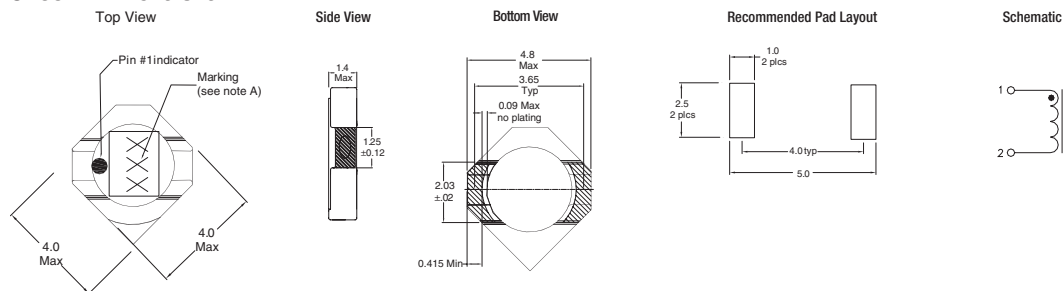

## Inductor Selection for Switching Regulators

SD14 & SD25						
Part Number	Rated Inductance (μH)	OCL ± 20% (μH)	Part Marking Designator	I <sub>rms</sub> Amps	I <sub>sat</sub> Amps	DCR Ω Typical
SD14-1R2-R	1.2	1.23	C	2.7	3.35	0.0344
SD14-1R5-R	1.5	1.63	D	2.53	2.91	0.0390
SD14-3R2-R	3.2	3.19	G	1.94	2.08	0.0663
SD14-6R9-R	6.9	6.98	J	1.35	1.41	0.1363
SD14-100-R	10	9.93	L	1.1	1.18	0.2058
SD14-220-R	22	21.93	N	0.806	0.793	0.3853
SD14-330-R	33	32.55	O	0.654	0.651	0.5852
SD14-470-R	47	47.57	P	0.525	0.538	0.9055
SD14-101-R	100	99.25	S	0.386	0.373	1.68
SD14-221-R	220	222	U	0.258	0.249	3.77
SD14-331-R	330	335.1	V	0.206	0.203	5.92
SD14-471-R	470	471.4	W	0.173	0.171	8.34
SD14-102-R	1000	1008	Z	0.126	0.117	15.8
SD25-1R2-R	1.20	1.15	C	3.33	3.81	0.0240
SD25-1R5-R	1.50	1.61	D	3.12	3.23	0.0274
SD25-2R2-R	2.20	2.14	E	2.93	2.80	0.0311
SD25-3R3-R	3.30	3.43	F	2.64	2.21	0.0384
SD25-4R7-R	4.70	5.03	G	2.39	1.83	0.0467
SD25-100-R	10.0	10.35	K	1.80	1.27	0.0824
SD25-220-R	22.0	22.81	M	1.34	0.857	0.1478
SD25-330-R	33.0	33.07	N	1.11	0.711	0.2149
SD25-470-R	47.0	47.89	O	0.919	0.592	0.3156
SD25-101-R	100	100.79	R	0.670	0.398	0.5937
SD25-151-R	150	148.4	S	0.553	0.328	0.8723
SD25-221-R	220	222.4	T	0.446	0.268	1.34
SD25-331-R	330	332.2	U	0.359	0.219	2.07
SD25-471-R	470	472.4	V	0.293	0.184	3.10

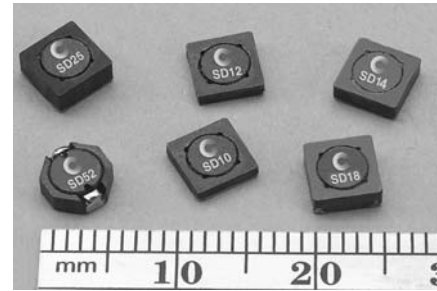

SD Inductor Series

### Typical SD Series Applications

- Mobile phones
- Digital cameras
- Industrial test equipment
- Computers
- Uninterruptible power supplies
- Televisions

### Typical SD Series Uses

- Buck and boost converters
- LED drivers
- EL panel drivers
- Backlighting
- Noise filtering chokes

**Note:** SD10, 12, 18 and 20 not shown. For full product information and a listing of all available inductor values, see <http://www.cooperbusmann.com/datasheets/elx>, Data sheet number SD Series

### SD14 & SD25 Dimensions - mm

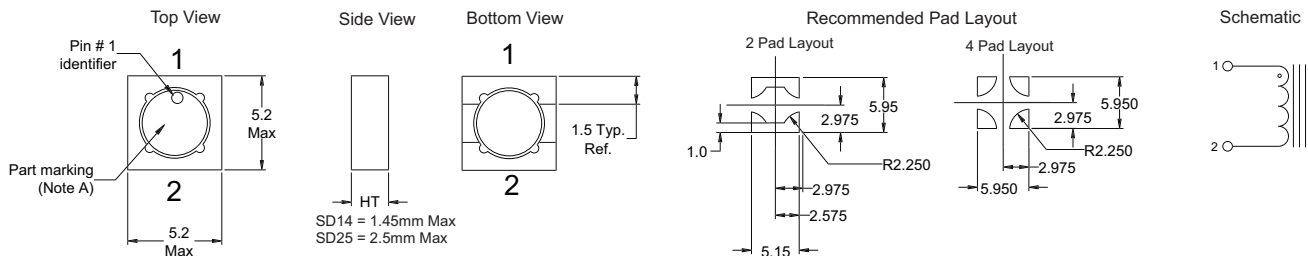

## Online Application and Technical Resources



### Available on the Web

Cooper Bussmann makes available many technical resources that can assist you in your electronics designs.

### Technical Application Assistance

- E-mail the experts with your inductor application questions. Send your inquiries to [InductorTech@cooperindustries.com](mailto:InductorTech@cooperindustries.com).

### Inductor Selection Guides

- Web-based decision trees for selecting the right inductor

### Application Notes

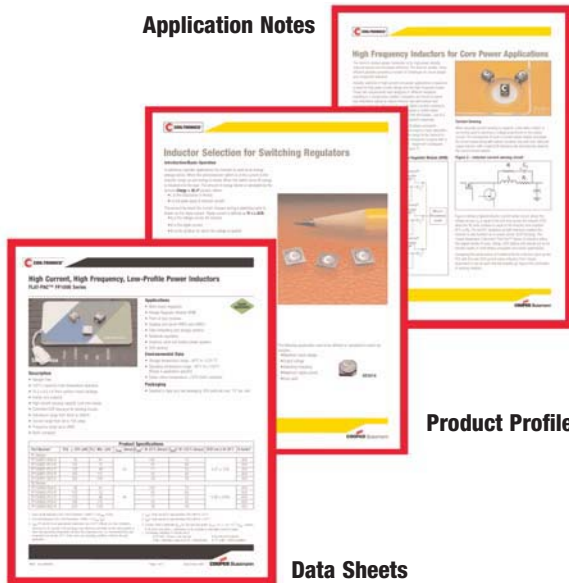

Product Profiles

Data Sheets

### Competitor Cross Reference

- Find the Coiltronics inductor to replace another manufacturer's

### Stock Check

- Check the inductor stock of leading distributors

### Inductor Calculators

- Downloadable Excel® spreadsheets with automatic formulas

### Where to Buy

- Distributor and sales representatives, worldwide

All these resources are available to you now on the Cooper Bussmann website. Just go to [www.cooperbussmann.com](http://www.cooperbussmann.com) and click on "Electronics" in the top navigation bar and select "Products" from the drop down menu, then click the Coiltronics logo.

### Samples, Too

Cooper Bussmann makes available inductor samples to qualified requesters. To request samples, go to [www.cooperbussmann.com/samples/elx](http://www.cooperbussmann.com/samples/elx).



## Overcurrent and Overvoltage Protection Products

Cooper Bussmann offers the Cooper Bussmann® brand of circuit protection products.

### Overcurrent Protection

- Primary or secondary circuit overcurrent protection
- Fast-acting and time-delay fuses
- Glass or ceramic tube, Chip™ and Brick™ surface mount and axial/radial leaded fuse packages
- Meet prevailing worldwide agency standards
- PCB fuseclips, fuse blocks and holders also available

### Overvoltage Protection

- PolySurg® ESD suppressors
- Surface mount packages

For data sheets and technical information, go to [www.cooperbussmann.com/datasheets/elx](http://www.cooperbussmann.com/datasheets/elx).



Surface mount fuses

SR5 Axial leaded fuse

ESD suppressor

Ferrule fuses with and without leads



## Supercapacitors for Holdup and Memory Protection

Cooper Bussmann offers the PowerStor® brand of supercapacitors. These supercapacitors are ideally suited for memory holdup, memory retention, battery replacement, peak power, pulse power, main power, DC-DC converters and solenoid actuation applications

### Packages

- Through hole and surface mount coin cell
- Leaded cylindrical and multi-cylindrical
- Custom packages to meet specific design requirements

For data sheets and technical information, go to [www.cooperbussmann.com/datasheets/elx](http://www.cooperbussmann.com/datasheets/elx).



Coincell KR Series



Cylindrical PM Series



# Your Source for Power Management Solutions

## Application Engineering

Technical assistance is available to all customers. Staffed by degreed engineers, this application support is available Monday – Friday

## Inductors and Transformers Products

Cooper Bussmann  
1225 Broken Sound Parkway NW  
Boca Raton, FL 33487-3533  
Contact, 8:00 a.m. – 5:00 p.m. Eastern Time

- Phone: 561-998-4100
- Toll Free: 888-414-2645
- Fax: 561-241-6640
- E-mail: InductorTech@cooperindustries.com

## Overcurrent and Overvoltage Protection Products

Cooper Bussmann  
114 Old State Road  
Ellisville, MO 63021  
Contact, 8:00 a.m. – 5:00 p.m. Central Time

- Phone: 636-527-1270
- Fax: 636-527-1607
- E-mail: FuseTech@cooperindustries.com

## Customer Satisfaction Team

Available to answer questions regarding Cooper Bussmann products & services Monday – Friday, 8:00 a.m. – 4:30 p.m. Central Time.

The Customer Satisfaction Team can be reached via:

- Phone: 636-527-3877
- Toll-free fax: 800-544-2570
- E-mail: busscustsat@cooperindustries.com

## C3 – the Enhanced, Online Cooper Customer Center

Provides real time product availability, net pricing, order status & shipment tracking across six Cooper divisions: B-line, Bussmann, Crouse-Hinds, Lighting, Power Systems & Wiring Devices. Call 877-995-5955 for log-in assistance. Available at:

- [www.cooperc3.com](http://www.cooperc3.com)

## Online Resources

Visit [www.cooperbussmann.com](http://www.cooperbussmann.com) for online catalogs, selection guides and product literature.