

Introduction

This application note describes the characteristics and features of a 65 W demonstration board (EVL6566B-65W-QR), tailored to the specifications of a typical hi-end portable computer power supply. The peculiarities of this design are the very high average efficiency of about 90%, without synchronous rectification, and very low no load consumption of 100 mW at 230 Vac. The result is that this converter is more than compliant with Energy Star[®] eligibility criteria (EPA rev. 2.0 EPS).

Figure 1. EVL6566B-65W-QR: 65 W adapter demonstration board

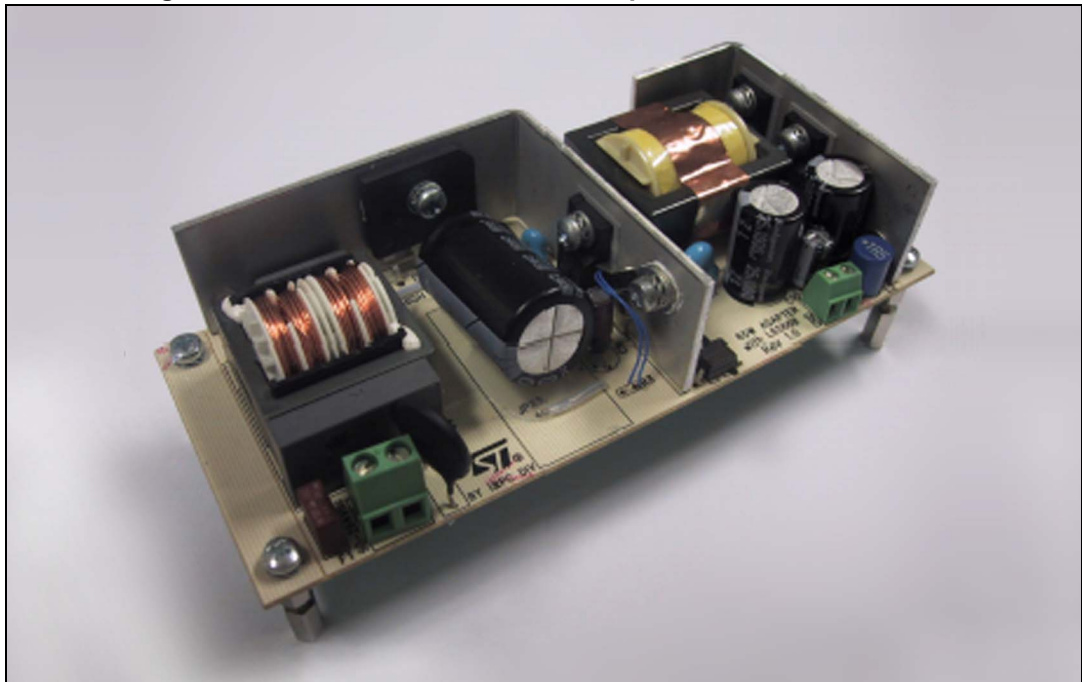

Contents

- 1 Main characteristics and circuit description 5**
 - 1.1 Power stage 5
 - 1.2 Startup 6
 - 1.3 Brownout protection 6
 - 1.4 Output regulation feedback loop 6
 - 1.5 L6566B current mode control and voltage feed forward function 7
 - 1.6 L6566B short-circuit protection 7
 - 1.7 Overvoltage protection 7
 - 1.8 Overtemperature protection 8
 - 1.9 Burst mode operation 8

- 2 Efficiency measurement 10**

- 3 Functional check 11**
 - 3.1 Standby and no load operation 12
 - 3.2 Overcurrent and short-circuit protection 13
 - 3.3 Overvoltage and open loop protection 14

- 4 Thermal map 16**

- 5 Conducted emission pre-compliance test 17**

- 6 Bill of material 18**

- 7 Transformer specification 21**

- 8 Revision history 24**

List of tables

Table 1.	Overall efficiency and no load consumption	10
Table 2.	Thermal map reference points	16
Table 3.	EVL6566B-65W-QR demonstration board: bill of material	18
Table 4.	Transformer winding data	21
Table 5.	Document revision history	24

List of figures

Figure 1.	EVL6566B-65W-QR: 65 W adapter demonstration board	1
Figure 2.	Electrical diagram	9
Figure 3.	Light-load efficiency	10
Figure 4.	Flyback stage waveforms at 115 V – 60 Hz – full load	11
Figure 5.	Flyback stage waveforms at 230 V – 50 Hz – full load	11
Figure 6.	Flyback stage waveforms at 115 V – 60 Hz – light-load	12
Figure 7.	Flyback stage waveforms at 230 V – 50 Hz – light-load	12
Figure 8.	No load operation at 90 V – 50 Hz	12
Figure 9.	No load operation at 265 V – 50 Hz	12
Figure 10.	Transition full load to no load at 265 Vac – 50 Hz	13
Figure 11.	Transition no load to full load at 265 Vac – 50 Hz	13
Figure 12.	Short-circuit at full load and 230 Vac – 50 Hz	14
Figure 13.	Short-circuit detail at full load and 230 Vac – 50 Hz	14
Figure 14.	Flyback open loop – detail at 230 V – 50 Hz – half load	15
Figure 15.	Flyback open loop at 230 V – 50 Hz –half load	15
Figure 16.	Thermal map at 115 Vac – 60 Hz – full load	16
Figure 17.	Thermal map at 230 Vac – 50 Hz – full load	16
Figure 18.	CE average measurement at 115 Vac and full load	17
Figure 19.	CE average measurement at 230 Vac and full load	17
Figure 20.	Transformer	21
Figure 21.	Transformer winding diagram	22
Figure 22.	Transformer mechanical diagrams	23

1 Main characteristics and circuit description

The main features of the SMPS are listed below:

- Universal input mains range: 90 ÷ 264 Vac - frequency 45 ÷ 65 Hz
- Output voltage: 19 V at 3.42 A continuous operation
- Mains harmonics: acc. to EN61000-3-2 Class-D or JEITA-MITI Class-D
- Standby mains consumption: < 100 mW at 230 Vac
- Average efficiency: better than 89% without synchronous rectification
- EMI: according to EN55022-Class-B
- Safety: according to EN60950
- Dimensions: 58 x 121 mm, 25 mm maximum component height
- PCB: single side, 35 µm, CEM-1, mixed PTH/SMT.

1.1 Power stage

The flyback converter implements the new ST dedicated current mode L6566B (U2) controller operating in quasi-resonant mode and detecting the transformer demagnetization through the ZCD (#11) pin.

R23 on the OSC (#13) pin sets the maximum switching frequency at about 165 kHz.

Because the maximum switching frequency is imposed, the converter operates in discontinuous conduction mode during light-load operation. The L6566B valley skipping function is capable of turning-on the MOSFET in valley switching even in DCM, therefore reducing switching losses.

The MOSFET is a standard 800 V, STF7NM80, housed in a TO-220FP package, needing just a small heatsink. The transformer is a layer type, using a standard ferrite size EER28L, designed according to EN60950 and manufactured by MAGNETICA.

The flyback reflected voltage is ~150 V, providing enough room for the leakage inductance voltage spike with a still margin for reliability of the MOSFET. The D5 rectifier and the D4 Transil™ clamp the peak of the leakage inductance voltage spike at MOSFET turn-off. A small capacitance in parallel with D4 smooth leakage inductance spikes, reducing EMI and Transil dissipation.

The output rectifiers are two STPS20H100CFP dual center tap Schottky diodes (D2 and D3) in parallel, housed in the TO-220FP. They have been selected according to the maximum reverse voltage, forward voltage drop, and power dissipation. The snubber, made up of R5, R7 and C12, dampens the oscillation produced by the diode capacitance and the leakage inductance.

A small LC filter has been added on the output, filtering the high frequency ripple and spikes.

D6, R4, R5, R8, R9, Q2 and Q3 implement an output voltage “fast discharge” circuit, quickly discharging the output capacitors when the converter is turned off. It has been implemented to quickly decrease the residual output voltage after the converter is turned off at no load.

1.2 Startup

The L6566B flyback controller pin #1 (HV) is directly connected to the bulk capacitor, and at startup an internal high voltage current source charges C9 until the L6566B turn-on voltage threshold is reached, then the high voltage current source is automatically switched off. As the IC starts switching it is initially supplied by the C9, then the transformer auxiliary winding (pins 5 - 6) provides the voltage to power the IC.

Because the L6566B integrated HV startup circuit is turned off, and therefore not dissipative during normal operation, it gives a significant contribution to power consumption reduction when the power supply operates at light-load.

1.3 Brownout protection

Brownout protection prevents the circuit from working with abnormal mains levels. It can be easily achieved using the AC_OK controller pin (#16).

This feature is typically implemented sensing the bulk voltage through a resistor divider, however on this board a different solution has been applied. The mains voltage is sensed before the bridge rectifier. This has two main achievements: it is less dissipative and it allows faster restart in case of latching, because there is no need to wait for the bulk capacitor discharge.

If the input voltage is below 90 Vac, the startup of the circuit is inhibited, while the turn-off voltage has been set at 80 Vac. The internal comparator has in fact a current hysteresis allowing to set the converter turn-on and turn-off voltage independently. R19 sets the relation between the comparator hysteresis and the actual voltage hysteresis.

C13, R20 and R21 set the discharging time constant of the AC_OK voltage. This value must be dimensioned properly, taking two main points into account:

- The voltage must keep up during the mains missing cycle to avoid the converter shutting down during mains dip
- In the case of converter switch-off, the voltage must go down promptly to avoid an operation with improper input voltage.

Basically, the ideal dimensioning would allow C13 to discharge slightly faster than the bulk capacitor in the case of switch-off at nominal load.

1.4 Output regulation feedback loop

Output regulation is done by means of two control loops, voltage and current, working alternatively. A dedicated control IC, the TSM1014 (U3), has been used. It integrates two operational amplifiers (used as error amplifiers) and a precise voltage reference. The output signal of the error amplifiers drives an SFH617A-4 (U1) optocoupler to achieve the required insulation of the secondary side and modulate the COMP pin (#9) voltage of the L6566B.

1.5 L6566B current mode control and voltage feed forward function

R16 senses the flyback MOSFET current and the signal is fed into the CS pin (#7) connected to the PWM comparator. This signal is compared with the COMP pin (#9) signal, which comes from the optocoupler.

The maximum power that the converter can deliver is set by a comparator limiting the peak of the primary current, comparing the CS and an internal threshold (V_{CSX}). If the current signal exceeds the threshold, the comparator limits the MOSFET duty cycle, hence the output power is limited too.

As the maximum transferable power depends on both the primary peak current and the input voltage, in order to keep the overload set point almost constant, which changes according to the flyback input voltage, the L6566B implements a voltage feed forward function via a dedicated pin. Therefore, V_{CSX} is modulated by the voltage on the VFF pin (#15) sensing the mains voltage through a resistor divider. A higher voltage causes a smaller $V_{CS,MAX}$ so that the maximum power can be kept almost constant at any input voltage.

On this board, VFF is implemented via the same circuit of brownout, saving components and reducing consumption at light-load.

1.6 L6566B short-circuit protection

An internal comparator senses the COMP pin after the soft-start time: in case of a short, the COMP pin goes high, and the said comparator activates a current source that restarts charging the soft-start capacitor from the initial 2 V level. If the voltage on this pin reaches 5 V, the L6566B stops the operation and enters into the so-called "hiccup mode". The L6566B restarts with a startup sequence when the Vcc voltage drops below the Vcc restart level (5 V). Because of the long time needed by the Vcc capacitor to drop to 5 V, it results in an increase of the duration of the no load operation, therefore decreasing the power dissipation and the stress of the power components. This sequence is repeated until the short is removed, after that normal operation of the converter is automatically resumed.

A second protection, dedicated to protecting the circuit in the case of MOSFETs or output diode short or transformer saturation, is implemented by another comparator on the CS pin (#7). If the voltage on this pin exceeds the 1.5 V threshold, the IC immediately shuts down. In this way a hiccup mode operation is still obtained, avoiding consequent failures due to the power components overheating. To prevent spurious activation of the protection in the case of temporary disturbances, for example during immunity tests, the comparator must be triggered two consecutive times.

1.7 Overvoltage protection

The ZCD pin (#11) is connected to the auxiliary winding by a resistor divider. It implements the OVP against feedback network failures. When the ZCD pin voltage exceeds 5 V four consecutive times, the IC is shut down. This protection can be set as a latch or an autorestart by the user with no additional components. On the board it is set as latched. Therefore the operations can be resumed after a mains recycling.

1.8 Overtemperature protection

The R3 thermistor, connected to the L6566B DIS pin (#8), provides a thermal protection of the flyback MOSFET (Q1). Therefore, in case of overheating, the flyback converter activity is latched off. To maintain this state, an internal circuitry of the L6566B monitors the Vcc and periodically reactivates the HV current source to supply the IC.

1.9 Burst mode operation

The L6566B implements a current mode control, thus it monitors the output power through the COMP pin, which has a level proportional to the load. Therefore, when the voltage on the COMP pin falls below an internal threshold, the controller is disabled and its consumption reduced; normal operation restarts as soon as the COMP voltage rises again. In this way a low consumption burst mode operation is obtained.

Figure 2. Electrical diagram

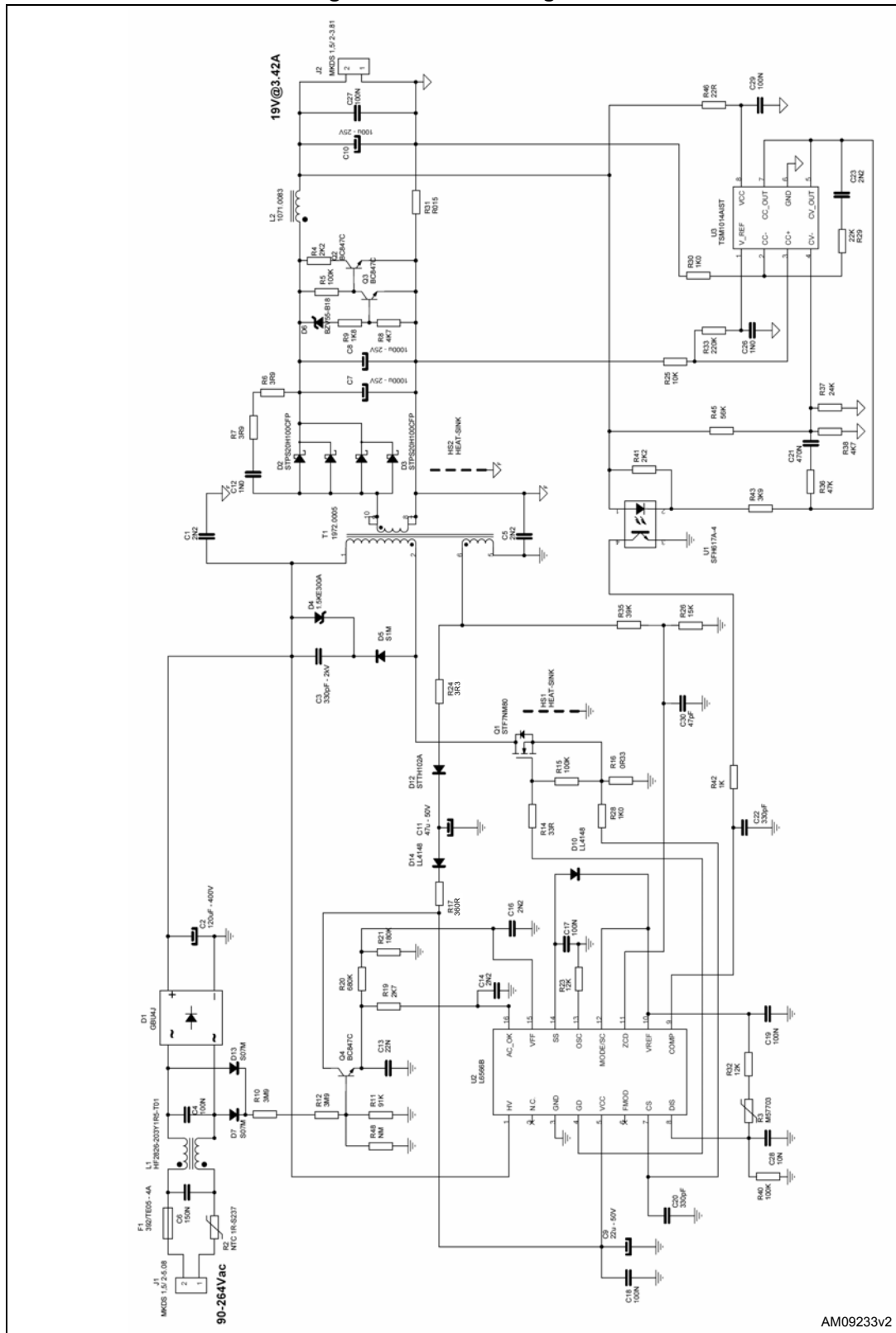

AM09233v2



2 Efficiency measurement

Table 1 shows the no load consumption and the overall efficiency, measured at the nominal mains voltages. Average efficiency is about 90% at both mains levels. This value is much higher than the 87% required by EPA rev2.0 external power supply limits.

Thanks to the L6566B valley skipping feature it has been possible to dimension the power transformer parameters, optimizing efficiency at different loads and achieving an outstanding result even without synchronous rectification.

Also at no load the board performances are superior: maximum no load consumption at nominal mains voltage is below 100 mW; this value is significantly lower than the limit imposed by the Energy Star program which is 500 mW. This has been obtained thanks to the embedded solutions of the L6566B that allow the minimization of consumption at light-load and avoid adding additional discrete circuits that generally increase overall consumption and component count (HV startup, latching circuit). In addition, the peculiar solution implemented for brownout protection has a very low consumption of about 5 mW.

Table 1. Overall efficiency and no load consumption

Test	230 V - 50 Hz					115 V - 60 Hz				
	Vout [V]	Iout [mA]	Pout [W]	Pin [W]	Eff. [%]	Vout [V]	Iout [A]	Pout [W]	Pin [W]	Eff. [%]
No load	19.00	0.00	0.00	94 mW	-----	19.00	0.00	0.00	75 mW	-----
25% load eff.	18.97	0.86	16.37	18.53	88.3	18.97	0.86	16.32	18.03	90.5
50% load eff.	18.97	1.71	32.50	35.77	90.9	18.97	1.72	32.54	35.91	90.6
75% load eff.	18.98	2.57	48.74	53.44	91.2	18.97	2.57	48.82	54.39	89.8
100% load eff.	18.98	3.42	64.89	71.18	91.2	18.98	3.42	64.99	73.30	88.7
Average eff.					90.4					89.9

Light-load efficiency measurement results are plotted in *Figure 3*. As shown, efficiency is better than 60% even at half-watt input power.

Figure 3. Light-load efficiency

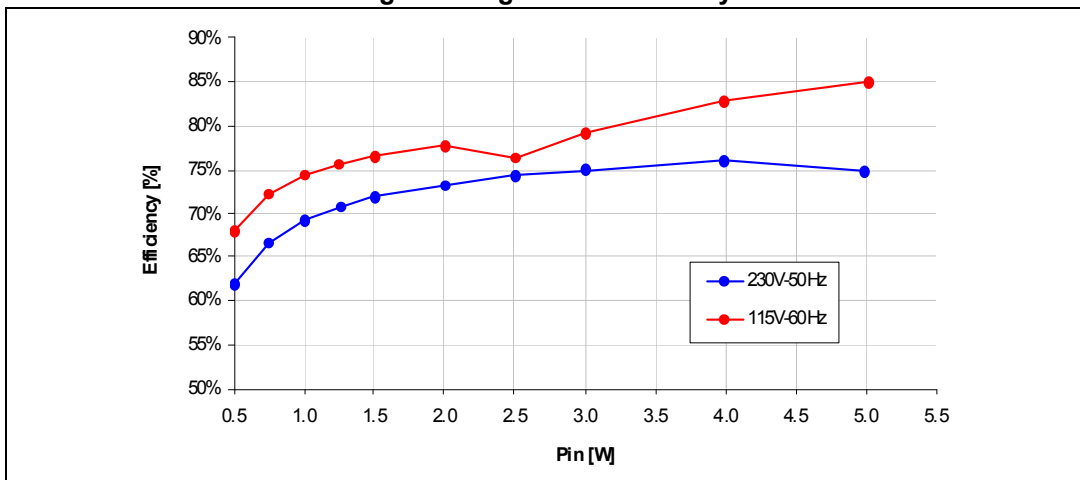

3 Functional check

Some flyback waveforms during steady state operation are reported here.

At nominal load conditions, in *Figure 4* and *Figure 5*, it is possible to note that the ZCD negative-going edge triggers MOSFET's turn-on, allowing quasi-resonant operation.

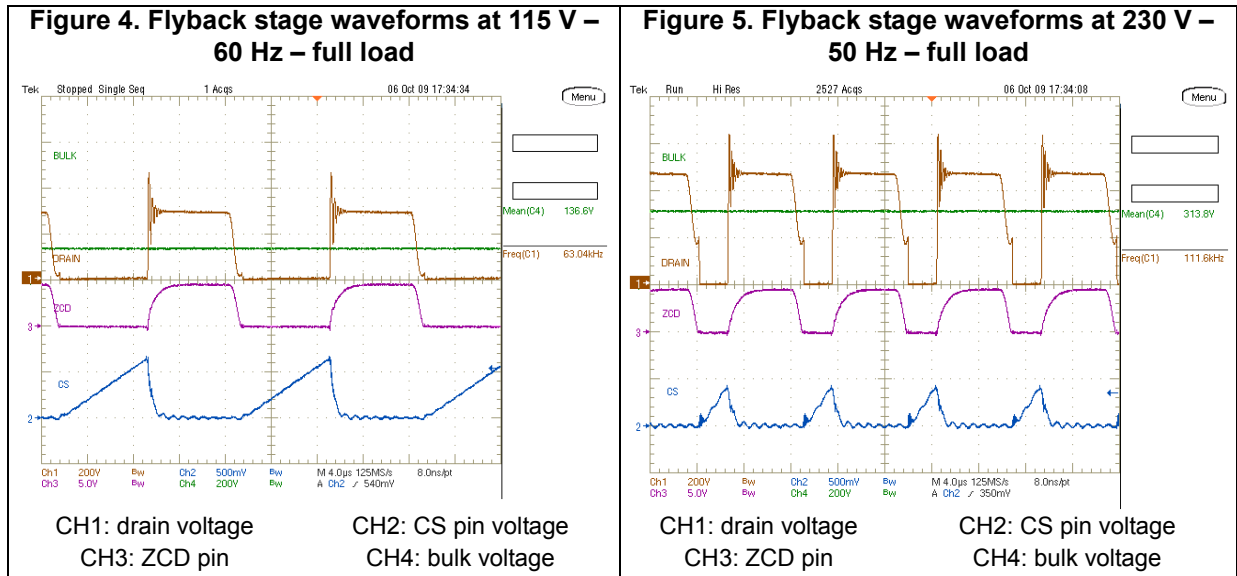
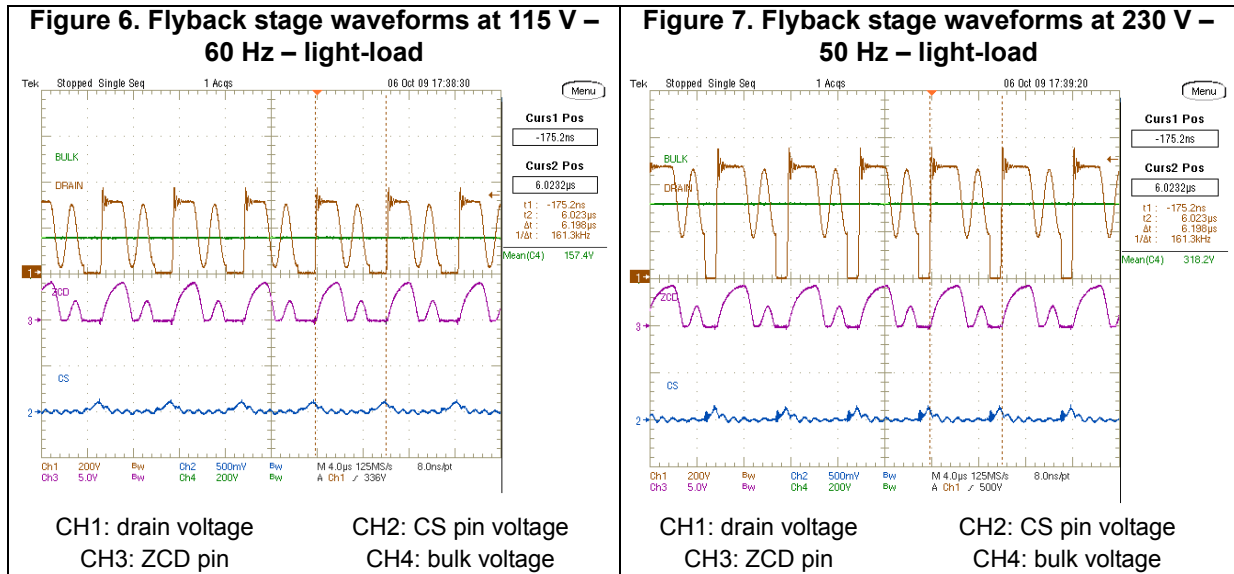
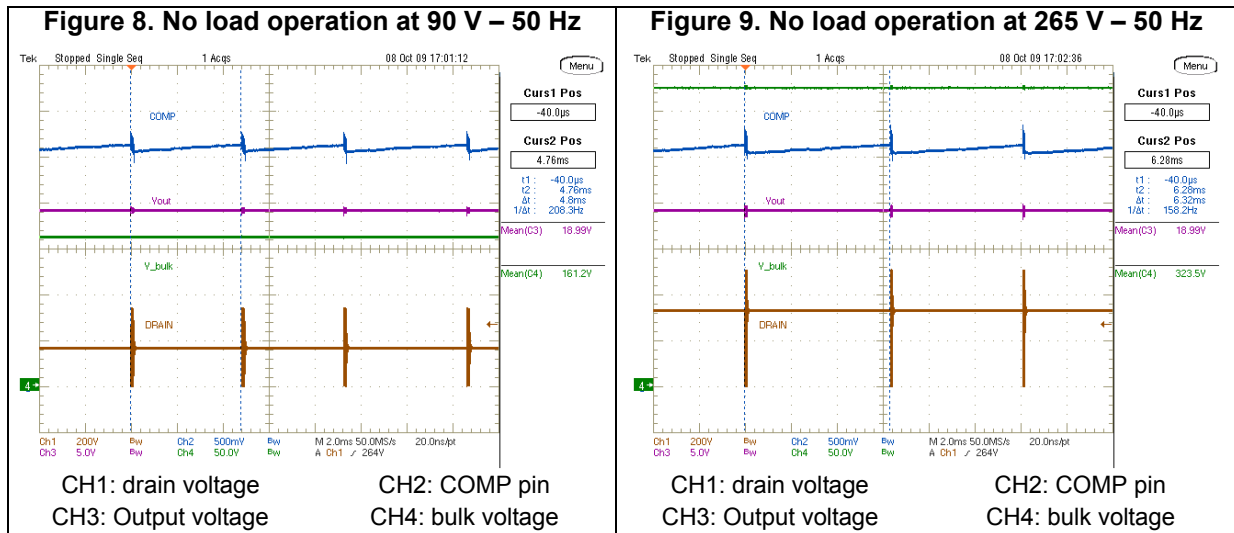

Figure 6 and Figure 7 show operation at light-load. As already indicated, maximum switching frequency has been set at 165 kHz. For this reason, the L6566B skips the first valley signal on ZCD and switches on the MOSFET at the second negative-going edge.



3.1 Standby and no load operation

In Figure 8 and Figure 9, some no load waveforms are captured. As shown, the L6566B works in the burst mode. When the feedback voltage at the COMP pin falls below 2.65 V (typical), the IC is disabled and its consumption is reduced. The chip is re-enabled as the voltage on the COMP pin rises over this threshold again. Therefore, the residual consumption of the PFC control circuitry is minimized to a negligible level.



In [Figure 10](#) and [Figure 11](#) the transitions from full load to no load and vice versa, at maximum input voltage, have been checked. The maximum input voltage has been chosen because it is the most critical input voltage for transition: in fact, at no load the burst pulses have the lower repetition frequency and the Vcc may drop, causing restart cycles of the controller. As shown, both transitions are clean and there isn't any output voltage or Vcc dip.

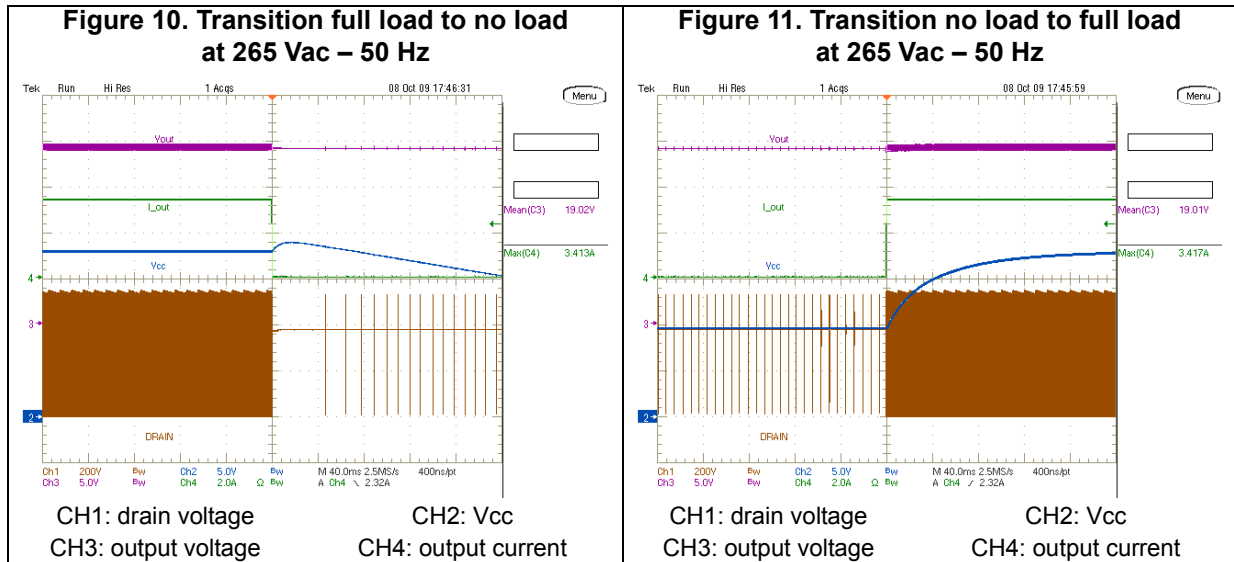

3.2 Overcurrent and short-circuit protection

In this demonstration board the overcurrent is managed by the TSM1014 (U3), a CC/CV controller. Inside the IC there is a voltage reference and two Or-ed operational amplifiers, one dedicated to act as the error amplifier of the voltage loop, and the second dedicated to act as the error amplifier of the current loop. During normal operation the voltage feedback loop is working, while in the case where the output current exceeds the programmed value, the current loop error amplifier takes over, therefore keeping the output current constant.

In case of a dead-short, the current cannot be limited effectively by U5 because the output voltage drops, and so it is unpowered, therefore the primary controller must manage the failure condition.

In case of an output short, there are two different possible situations which the controller must handle: if the coupling between the secondary winding and the auxiliary winding is good, as soon as the output voltage drops, the auxiliary voltage drops as well and the IC supply voltage falls below the undervoltage lockout threshold, causing the L6566B to stop switching. It remains in the off-state until the voltage on the Vcc pin decreases below the $V_{cc_restart}$ threshold (5 V), then, the HV startup turns on and charges the Vcc capacitor; as soon as the turn-on threshold is reached, the circuit restarts. If the short is still there, the circuit just attempts to restart but it stops after a few milliseconds. Restart attempts are repeated indefinitely until the short is removed. This provides a very low frequency hiccup working mode (for this board 1 Hz), limiting the current flowing at the secondary side (less than 1 Arms) preventing the power supply from overheating, which could destroy it. In the case where the coupling between the auxiliary and secondary winding is poor, some spikes on the auxiliary voltage may keep Vcc above the UVLO threshold for a period long enough to damage the converter. In this case the L6566B detects a short-circuit by monitoring the control pins: in the case of a short, the COMP pin goes high, and an internal

comparator activates a current source that restarts charging the soft-start capacitor from the initial 2 V level. If the voltage on this pin reaches 5 V, the L6566B stops the operation and it restarts with a startup sequence when the Vcc voltage drops below the $V_{CCrestart}$ level (5 V), entering into the so-called “hiccup mode”.

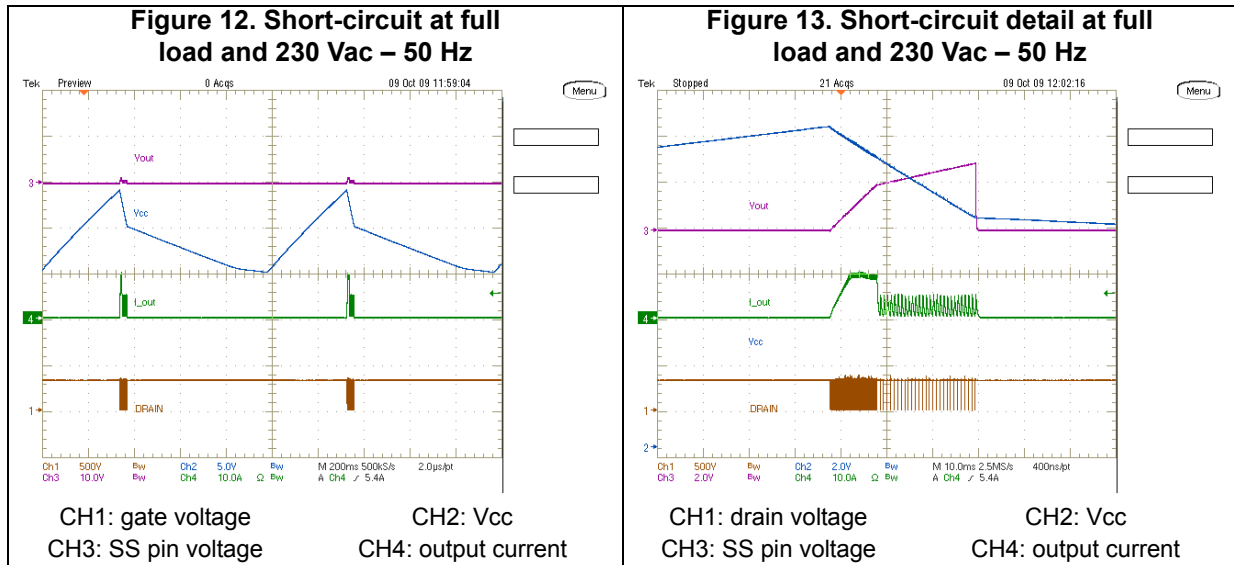

In [Figure 12](#) we can see that, in this case, the IC supply voltage drops to the UVLO threshold (10 V), causing controller turn-off before the SS pin signal achieves the disable threshold (5 V). This happens because the transformer leakage inductance is very low and once the output voltage drops, the auxiliary voltage also immediately drops. Furthermore, in the image we can note that during the SS voltage ramping-up the transferred power is limited.

3.3 Overvoltage and open loop protection

The L6566B OVP function monitors the voltage on the ZCD pin (#11) during the MOSFET's OFF-time, when the voltage generated by the auxiliary winding tracks the converter's output voltage. If the voltage on the pin exceeds an internal 5 V reference, an overvoltage condition is assumed and the device is shut down. An internal current generator is activated which sources 1 mA out of the VFF pin (#15). If the VFF voltage is allowed to reach 2 VBE over 5 V, the L6566B is latched off ([Figure 14](#)). As soon as the IC is latched, Vcc starts decreasing until it reaches a value 0.5 V below the turn-on threshold. Then the HV startup circuit turns on and begins to operate periodically in order to keep Vcc between VCCON and VCCON-0.5V ([Figure 15](#)), maintaining the IC latched.

Additionally, to improve immunity against temporary disturbances (needed for example in case of immunity tests), an internal logic activates the protection after the OVP has been detected for 4 consecutive switching cycles.

Figure 14. Flyback open loop – detail at 230 V – 50 Hz – half load

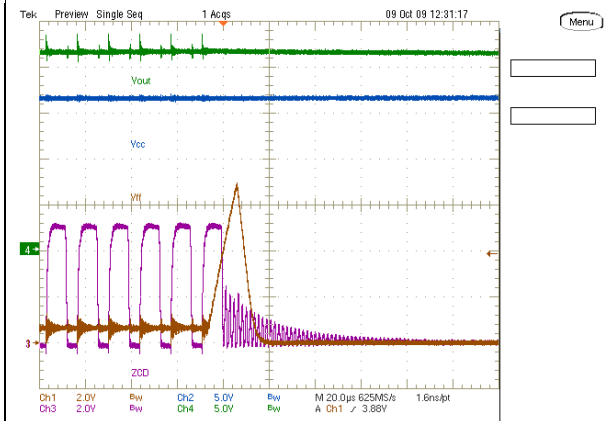

CH1: V_{FF} voltage
 CH3: ZCD voltage
 CH2: V_{cc}
 CH4: output voltage

Figure 15. Flyback open loop at 230 V – 50 Hz – half load

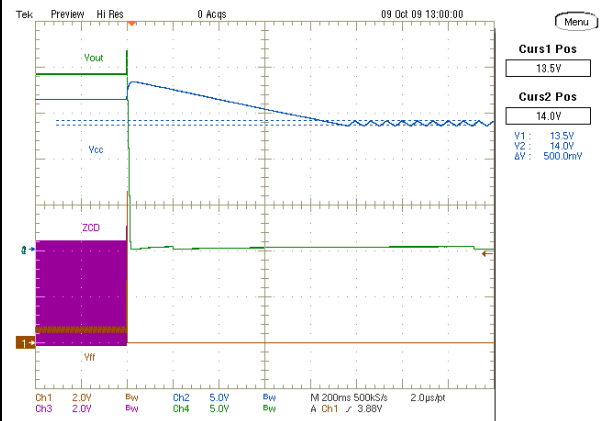

CH1: V_{FF} voltage
 CH3: ZCD voltage
 CH2: V_{cc}
 CH4: output voltage

4 Thermal map

In order to check the design reliability, a thermal mapping by means of an IR camera was done. In [Figure 16](#) and [17](#) the thermal measurements of the board, component side, at nominal input voltage are shown. Some pointers visible in the images have been placed across key components or components showing high temperature. The ambient temperature during both measurements was 27 °C.

Figure 16. Thermal map at 115 Vac – 60 Hz – full load

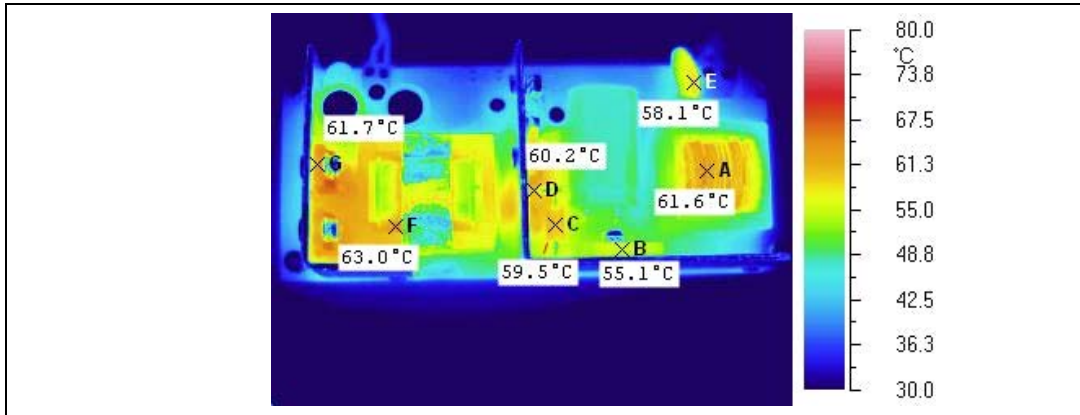

Figure 17. Thermal map at 230 Vac – 50 Hz – full load

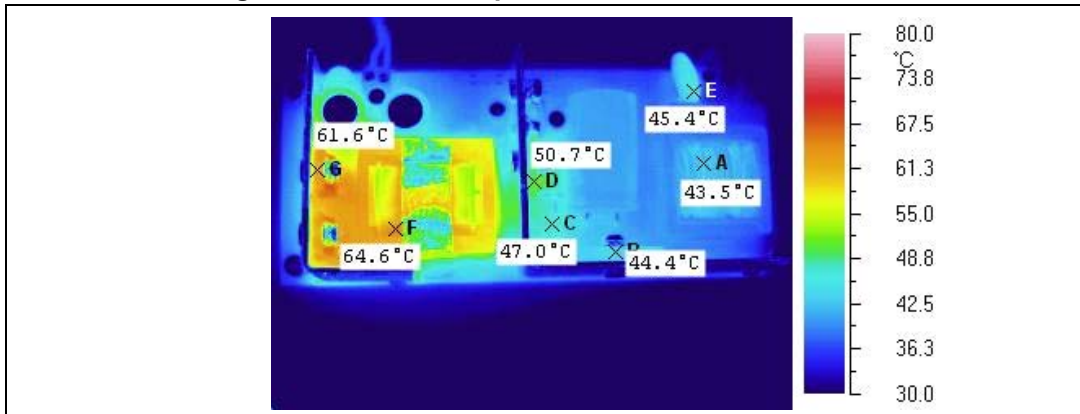

Table 2. Thermal map reference points

Point	Reference	Description
A	L1	EMI filtering common mode choke
B	D1	Bridge rectifier
C	D4	Clamping Transil
D	Q1	Flyback power MOSFET
E	R2	Input NTC
F	T1	Flyback power transformer
G	D2	Output diode

5 Conducted emission pre-compliance test

Figure 18 and 19 show the average measurement of the conducted noise at full load and nominal mains voltages. The limits shown on the diagrams are EN55022 Class-Bs, which is the most popular rule for domestic equipment and has more severe limits compared to Class-A, dedicated to IT technology equipment. As shown in the diagrams, in all test conditions the measurements are far below the limits.

Figure 18. CE average measurement at 115 Vac and full load

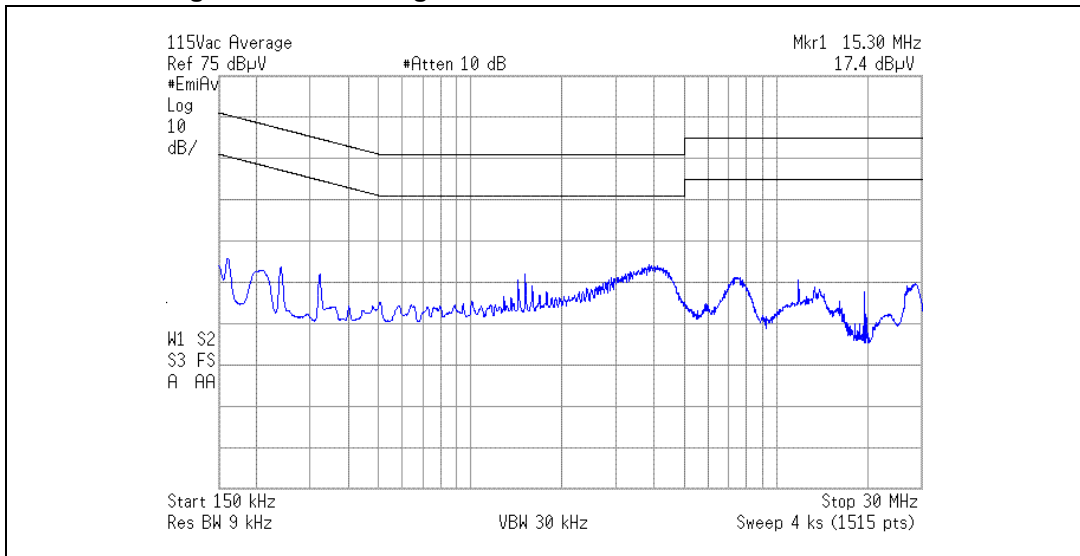
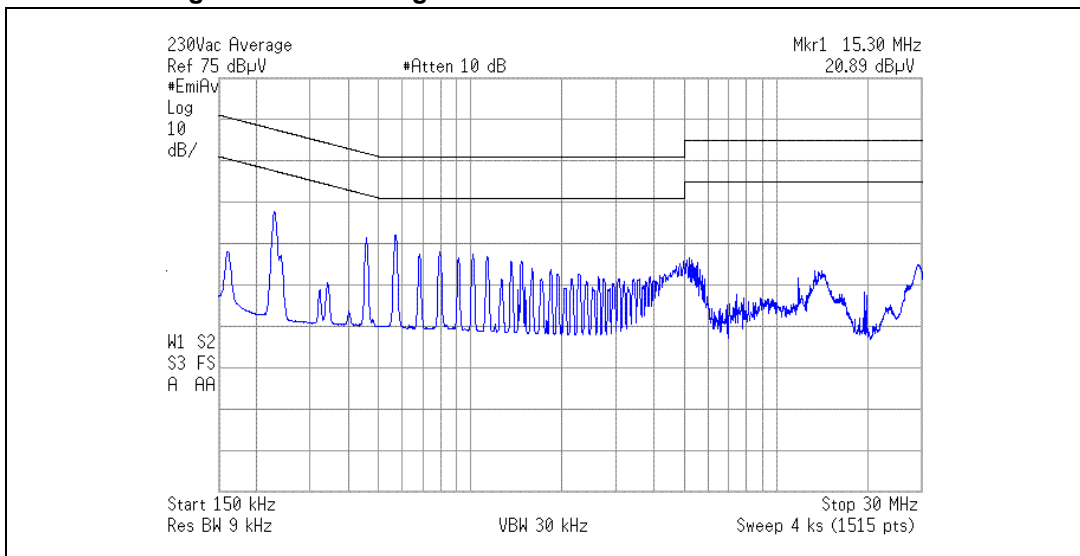

Figure 19. CE average measurement at 230 Vac and full load



6 Bill of material

Table 3. EVL6566B-65W-QR demonstration board: bill of material

Des.	Part type/ part value	Description	Supplier	Case
C1	2.2 nF	Y1 - safety cap. DE1E3KX222M	Murata	12 x 4 mm p.10 mm
C2	120 uF - 400 V	400 V - aluminium ELCAP - KXW series	Rubycon	Dia. 18 mm
C3	330 pF - 2 kV	2 kV - disc CERCAP	Murata	p. 8 mm
C4	100 nF	X2 - FLM cap. - R46-I 3100--M1-	Arcotronics	18 x 5 mm p.15 mm
C5	2.2 nF	Y1 - safety cap. DE1E3KX222M	Murata	12 x 4 mm p. 10 mm
C6	150 nF	X2 - FLM cap. - R46 KN 3150 - 01 -	Arcotronics	26 x 6 mm p. 22.5 mm
C7	1000 µF - 25 V	25 V - aluminium ELCAP - ZL SERIES	Rubycon	Dia. 13 mm
C8	1000 µF - 25 V	25 V - aluminium ELCAP - ZL SERIES	Rubycon	Dia. 13 mm
C9	22 µF - 50 V	50 V - aluminium ELCAP - YXF SERIES	Rubycon	Dia. 6 mm
C10	100 µF - 25 V	25 V - aluminium ELCAP - YXF SERIES	Rubycon	Dia. 6 mm
C11	47 µF - 50 V	50 V - aluminium ELCAP - YXF SERIES	Rubycon	Dia. 6 mm
C12	1 nF	200 V CERCAP - general purpose	AVX	1206
C13	22 nF	50 V CERCAP - general purpose	AVX	0805
C14	2.2 nF	50 V CERCAP - general purpose	AVX	0805
C16	2.2 nF	50 V CERCAP - general purpose	AVX	0805
C17	100 nF	50 V CERCAP - general purpose	AVX	0805
C18	100 nF	50 V CERCAP - general purpose	AVX	1206
C19	100 nF	50 V CERCAP - general purpose	AVX	1206
C20	330 pF	50 V CERCAP - general purpose	AVX	1206
C21	470 nF	50 V CERCAP - general purpose	AVX	0805
C22	330 pF	50 V CERCAP - general purpose	AVX	1206
C23	2.2 nF	50 V CERCAP - general purpose	AVX	1206
C26	1 nF	50 V CERCAP - general purpose	AVX	1206
C27	100 nF	50 V CERCAP - general purpose	AVX	0805
C28	10 nF	50 V CERCAP - general purpose	AVX	1206
C29	100 nF	50 V CERCAP - general purpose	AVX	0805
C30	47 pF	50 V CERCAP - general purpose	AVX	1206
D1	GBU4J	Single-phase bridge rectifier	VISHAY	GBU STYLE
D2	STPS20H100CFP	HV power Schottky rectifier	STMicroelectronics	TO - 220 FP
D3	STPS20H100CFP	HV power Schottky rectifier	STMicroelectronics	TO - 220 FP
D4	1.5 KE300A	Transil	STMicroelectronics	DO-201
D5	S1M	High voltage rectifier	Vishay	SMA

Table 3. EVL6566B-65W-QR demonstration board: bill of material (continued)

Des.	Part type/ part value	Description	Supplier	Case
D6	BZV55-B18	Zener diode	Philips	SOD-80
D7	S07M	High voltage diode	Vishay	SMF DO-219AB
D10	LL4148	Fast switching diode	Vishay	SOD-80
D12	STTH102A	Fast switching diode	STMicroelectronics	SMA
D13	S07M	High voltage diode	Vishay	SMF D0-219AB
D14	LL4148	Fast switching diode	Vishay	SOD-80
F1	392/TE05 - 4 A	Fuse T4A - time delay	Littelfuse	DWG
HS1	Heatsink	Bridge rect. and MOSFET heatsink	-	DWG
HS2	Heatsink	Output rectifiers heatsink	-	DWG
J1	MKDS 1,5/ 2-5.08	Screw conn., pitch 5.08 mm - 2 w.	Phoenix contact	DWG
J2	MKDS 1,5/ 2-3.81	Screw conn., pitch 3.81 mm - 2 w.	Phoenix contact	DWG
L1	HF2826- 203Y1R5-T01	Input EMI filter	TDK	DWG
L2	1071.0083	1.1 μ H - 5 A - radial inductor	MAGNETICA	Dia. 9 mm p. 5 mm
Q1	STF7NM80	N-channel power MOSFET	STMicroelectronics	TO-220FP
Q2	BC847C	NPN small signal BJT	ZETEX	SOT-23
Q3	BC847C	NPN small signal BJT	ZETEX	SOT-23
Q4	BC847C	NPN small signal BJT	ZETEX	SOT-23
R2	NTC 1R-S237	NTC resistor P/N B57237S0100M000	EPCOS	12 x 4 mm p. 10 mm
R3	M57703	Thermistor - B57703M103G	EPCOS	DWG
R4	2.2 K Ω	SMD film res. - 1/4 W - 5% - 250 ppm/ $^{\circ}$ C	Vishay	1206
R5	100 K Ω	SMD film res. - 1/8 W - 5% - 250 ppm/ $^{\circ}$ C	Vishay	0805
R6	3.9 Ω	SMD film res. - 1/4 W - 5% - 250 ppm/ $^{\circ}$ C	Vishay	1206
R7	3.9 Ω	SMD film res. - 1/4 W - 5% - 250 ppm/ $^{\circ}$ C	Vishay	1206
R8	4.7 K Ω	SMD film res. - 1/8 W - 5% - 250 ppm/ $^{\circ}$ C	Vishay	0805
R9	1.8 K Ω	SMD film res. - 1/8 W - 5% - 250 ppm/ $^{\circ}$ C	Vishay	0805
R10	3.9 M Ω	SMD film res. - 1/4 W - 5% - 100 ppm/ $^{\circ}$ C	Vishay	1206
R11	91 K Ω	SMD film res. - 1/4 W - 1% - 100 ppm/ $^{\circ}$ C	Vishay	0805
R12	3.9 M Ω	SMD film res. - 1/4 W - 1% - 100 ppm/ $^{\circ}$ C	Vishay	1206
R14	33 Ω	SMD film res - 1/8 W - 5% - 250 ppm/ $^{\circ}$ C	Vishay	0805
R15	100 K Ω	SMD film res - 1/8 W - 5% - 250 ppm/ $^{\circ}$ C	Vishay	0805
R16	0.33 Ω	MSR1 SMD film res. - 1 W - 5% - 250 ppm/ $^{\circ}$ C	MEGGIT	2512
R17	360 Ω	SMD film res. - 1/4 W - 5% - 250 ppm/ $^{\circ}$ C	Vishay	1206
R19	2.7 K Ω	SMD film res. - 1/4 W - 1% - 100 ppm/ $^{\circ}$ C	Vishay	1206

Table 3. EVL6566B-65W-QR demonstration board: bill of material (continued)

Des.	Part type/ part value	Description	Supplier	Case
R20	680 K Ω	SMD film res. - 1/4W - 1% - 100 ppm/ $^{\circ}$ C	Vishay	1206
R21	180 K Ω	SMD film res. - 1/8W - 1% - 100 ppm/ $^{\circ}$ C	Vishay	0805
R23	12 K Ω	SMD film res. - 1/8 W - 1% - 100 ppm/ $^{\circ}$ C	Vishay	0805
R24	3.3 Ω	SMD film res. - 1/4 W - 5% - 250 ppm/ $^{\circ}$ C	Vishay	1206
R25	10 K Ω	SMD film res. - 1/8 W - 5% - 250 ppm/ $^{\circ}$ C	Vishay	0805
R26	15 K Ω	SMD film res. - 1/4 W - 5% - 250 ppm/ $^{\circ}$ C	Vishay	1206
R28	1 K Ω	SMD film res. - 1/8 W - 5% - 250 ppm/ $^{\circ}$ C	Vishay	0805
R29	22 K Ω	SMD film res. - 1/8 W - 5% - 250 ppm/ $^{\circ}$ C	Vishay	0805
R30	1 K Ω	SMD film res. - 1/4 W - 5% - 250 ppm/ $^{\circ}$ C	Vishay	1206
R31	0.15 Ω	MSR1 SMD film res. - 1 W - 5% - 250 ppm/ $^{\circ}$ C	MEGGIT	2512
R32	12 K Ω	SMD film res. - 1/8 W - 5% - 250 ppm/ $^{\circ}$ C	Vishay	0805
R33	220 K Ω	SMD film res. - 1/4 W - 5% - 250 ppm/ $^{\circ}$ C	Vishay	1206
R35	39 K Ω	SMD film res. - 1/4 W - 5% - 250 ppm/ $^{\circ}$ C	Vishay	1206
R36	47 K Ω	SMD film res. - 1/8 W - 5% - 250 ppm/ $^{\circ}$ C	Vishay	0805
R37	24 K Ω	SMD film res. - 1/8 W - 1% - 100 ppm/ $^{\circ}$ C	Vishay	0805
R38	4.7 K Ω	SMD film res. - 1/8 W - 1% - 100 ppm/ $^{\circ}$ C	Vishay	0805
R40	100 K Ω	SMD film res. - 1/4 W - 5% - 250 ppm/ $^{\circ}$ C	Vishay	1206
R41	2.2 K Ω	SMD film res. - 1/8 W - 5% - 250 ppm/ $^{\circ}$ C	Vishay	0805
R42	1 K Ω	SMD film res. - 1/4 W - 5% - 250 ppm/ $^{\circ}$ C	Vishay	1206
R43	3.9 K Ω	SMD film res. - 1/8 W - 5% - 250 ppm/ $^{\circ}$ C	Vishay	0805
R45	56 K Ω	SMD film res. - 1/4 W - 1% - 100 ppm/ $^{\circ}$ C	Vishay	1206
R46	22 Ω	SMD film res. - 1/8 W - 5% - 250 ppm/ $^{\circ}$ C	Vishay	0805
T1	1972.0005	Power transformer	MAGNETICA	DWG
U1	SFH617A-4	Optocoupler	Infineon	DIP-4
U2	L6566B	Multimode PWM controller	STMicroelectronics	SO-16
U3	TSM1014AIST	Low consumption CC/CV controller	STMicroelectronics	MiniSO-8

7 Transformer specification

General description and characteristics

- Application type: consumer, home appliance
- Transformer type: open
- Coil former: horizontal type, 6 + 6 pins
- Max. temp. rise: 45 °C
- Max. operating ambient temperature: 60 °C
- Mains insulation: acc. with EN60950

Electrical characteristics

- Converter topology: QR flyback
- Core type: EER28L-PC44 or equivalent
- Typical operating frequency: 100 kHz
- Primary inductance: 500 $\mu\text{H} \pm 10\%$ at 1 kHz - 0.25 V^(a)
- Leakage inductance: 5 μH max. at 100 kHz - 0.25 V^(b)

Figure 20. Transformer

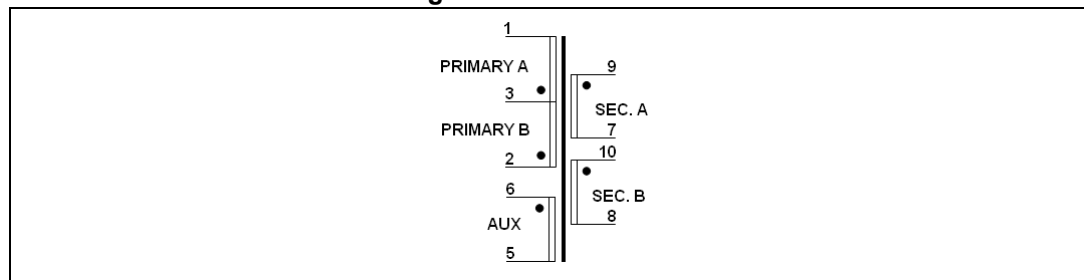

Table 4. Transformer winding data

Pins	Winding	RMS current	Number of turns	Wire type
3 - 1	PRIMARY A ⁽¹⁾	0.84 A _{RMS}	27	G1 ϕ 30 x 0.1 mm
9 - 7	SEC - A ⁽²⁾	2.9 A _{RMS}	7	G1 ϕ 90 x 0.1 mm
10 - 8	SEC - B ⁽²⁾	2.9 A _{RMS}	7	G1 ϕ 90 x 0.1 mm
2 - 3	PRIMARY B ⁽¹⁾	0.84 A _{RMS}	27	G1 ϕ 30 x 0.1 mm
6 - 5	AUX	0.05 A _{RMS}	6 spaced	G2 ϕ 0.25 mm

1. Secondary windings are wound between primary A and primary B layers.
2. Secondary windings A and B are in parallel.

a. Measured between pins 2 - 1.

b. Measured between pins 2 - 1 with secondary windings shorted.

Figure 21. Transformer winding diagram

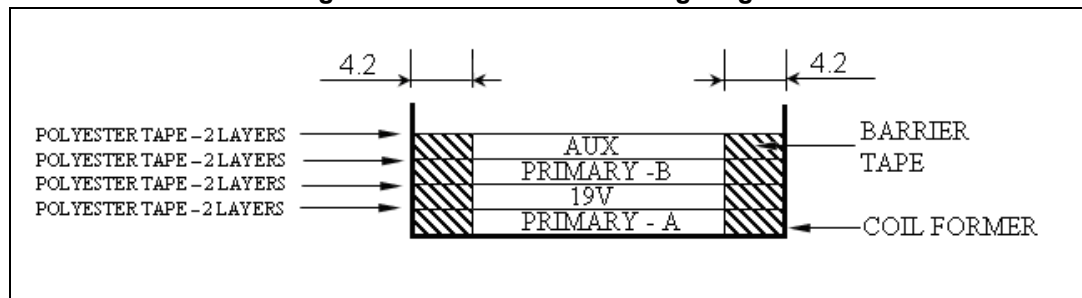

Mechanical aspect and pin numbering

- Maximum height from PCB: 26 mm
- Coil former type: horizontal, 6 + 6 pins (pins 4, 11 and 12 removed)
- Pin distance: 5.08 mm
- Row distance: 30 mm
- External copper shield: not insulated, wound around the ferrite core and including the coil former. Height is 12 mm.

Figure 22. Transformer mechanical diagrams

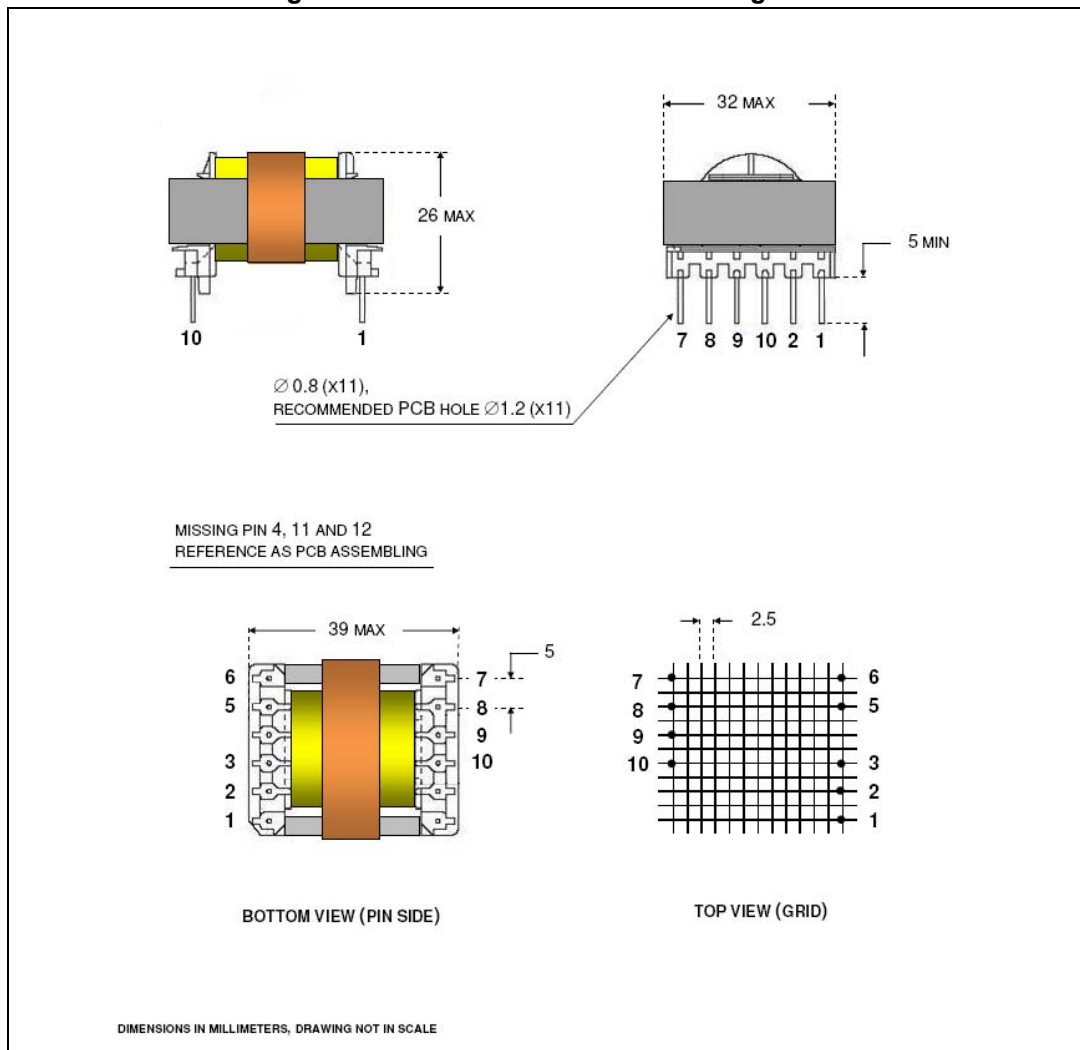

Manufacturer

- MAGNETICA - Italy
- Transformer P/N: 1972.0005.

8 Revision history

Table 5. Document revision history

Date	Revision	Changes
01-Jul-2010	1	Initial release.
06-Oct-2014	2	Updated Figure 2: Electrical diagram on page 9 - improvement startup at light-load (replaced value of R17 - "470R" by "360R" and R24 - "6R8" by "3R3"). Updated Table 3: EVL6566B-65W-QR demonstration board: bill of material on page 18 - improvement startup at light-load (replaced value of R17 - "470R" by "360 Ω " and R24 - "6R8" by "3.3 Ω "). Minor modifications throughout document.

IMPORTANT NOTICE – PLEASE READ CAREFULLY

STMicroelectronics NV and its subsidiaries (“ST”) reserve the right to make changes, corrections, enhancements, modifications, and improvements to ST products and/or to this document at any time without notice. Purchasers should obtain the latest relevant information on ST products before placing orders. ST products are sold pursuant to ST’s terms and conditions of sale in place at the time of order acknowledgement.

Purchasers are solely responsible for the choice, selection, and use of ST products and ST assumes no liability for application assistance or the design of Purchasers’ products.

No license, express or implied, to any intellectual property right is granted by ST herein.

Resale of ST products with provisions different from the information set forth herein shall void any warranty granted by ST for such product.

ST and the ST logo are trademarks of ST. All other product or service names are the property of their respective owners.

Information in this document supersedes and replaces information previously supplied in any prior versions of this document.

© 2014 STMicroelectronics – All rights reserved