

NCV8871BSTGEVB

NCV8871 Automotive Grade Boost Controller Audio Amplifier Evaluation Board User's Manual



ON Semiconductor®

www.onsemi.com

EVAL BOARD USER'S MANUAL

Description

The NCV8871BST evaluation board provides an opportunity to evaluate the NCV887100 in an audio amplifier power supply type application. The board supplies an 18 V output with 9 A of output current from as low as a 6 V input. The enable pin can also be used to synchronize the supply to an external clock.

Key Features

- 18 V Output Voltage
- 9 A Output Current
- Fixed Frequency Operation at 170 kHz
- Regulates Fully Loaded From as Low as 6 V Input
- Survives 40 V Load Dump
- External Clock Synchronization up to 340 kHz
- Automotive Grade

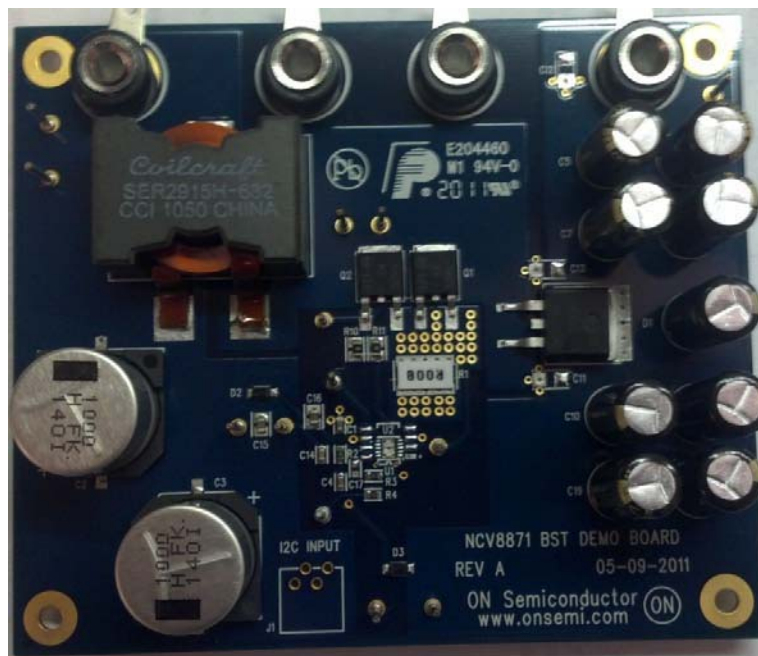

Figure 1. NCV8871BSTGEVB Evaluation Board

NCV8871BSTGEVB

Table 1. EVALUATION BOARD TERMINAL DESCRIPTIONS

Terminal	Function
VIN	Positive dc input voltage.
GND	Common dc return.
VOUT	Dc output voltage.
EN/SYNC	Dc enable voltage and external clock synchronization. A dc logic low disables the device.

Table 2. ABSOLUTE MAXIMUM RATINGS (Voltages are with respect to GND)

Rating	Value	Unit
Dc Supply Voltage (VIN)	-0.3 to 40	V
Dc Supply Voltage (EN/SYNC)	-0.3 to 6	V
Ambient Temperature	-40 to 85	°C

Stresses exceeding those listed in the Maximum Ratings table may damage the device. If any of these limits are exceeded, device functionality should not be assumed, damage may occur and reliability may be affected.

Table 3. ELECTRICAL CHARACTERISTICS

(TA = 25°C, 4.5 ≤ VIN ≤ 18 V, IOUT ≤ 2 A, unless otherwise specified)

Characteristic	Conditions	Typical Value	Unit
OUTPUT VOLTAGE			
Output Voltage		18.00	V
Voltage Accuracy	-40 ≤ TA ≤ 85	4	%
Soft-start Time		7.4	ms
SWITCHING REGULATOR			
Switching Frequency		170	kHz
SYNC Frequency		170 to 340	kHz
Duty Cycle Range		2 to 88	%
Current Limit			
Cycle-by-cycle current limit		50	A
General			
Input Undervoltage Lockout (UVLO)	VIN increasing	3.8	V
Efficiency	VIN = 13.2 V, IOUT = 5 A	85	%
Thermal Shutdown		170	°C

NCV8871BSTGEVB

TYPICAL WAVEFORMS

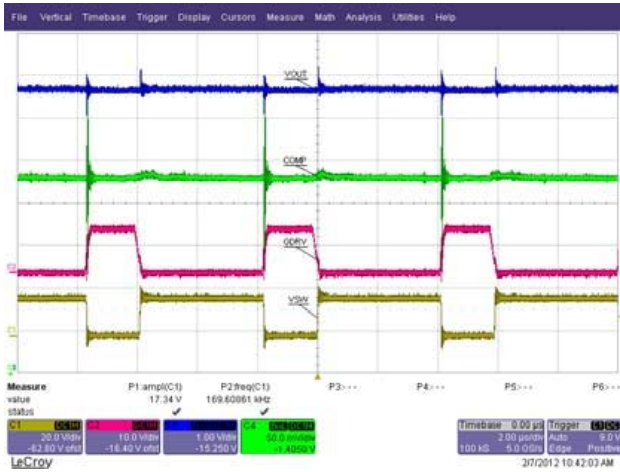

Figure 2. Normal Operation

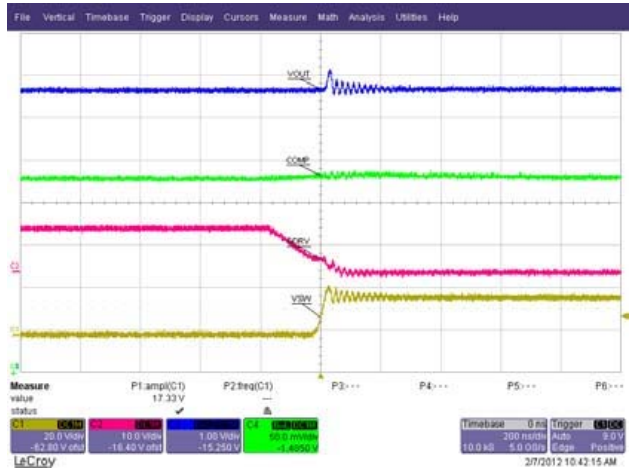

Figure 3. Gate Drive Falling Edge

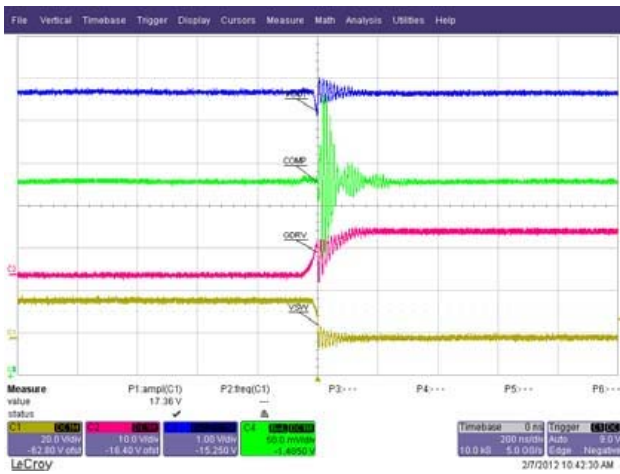

Figure 4. Gate Drive Rising Edge

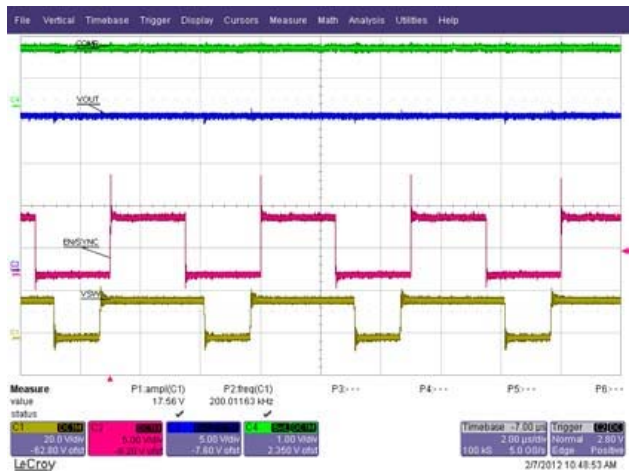

Figure 5. Synchronization

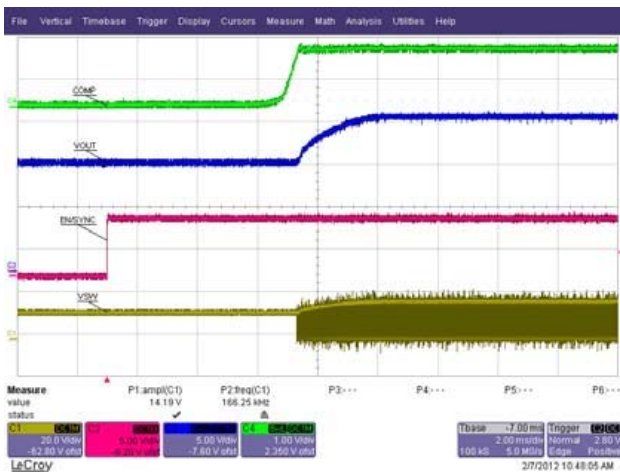

Figure 6. Soft Start with Load

NCV8871BSTGEVB

SCHEMATIC

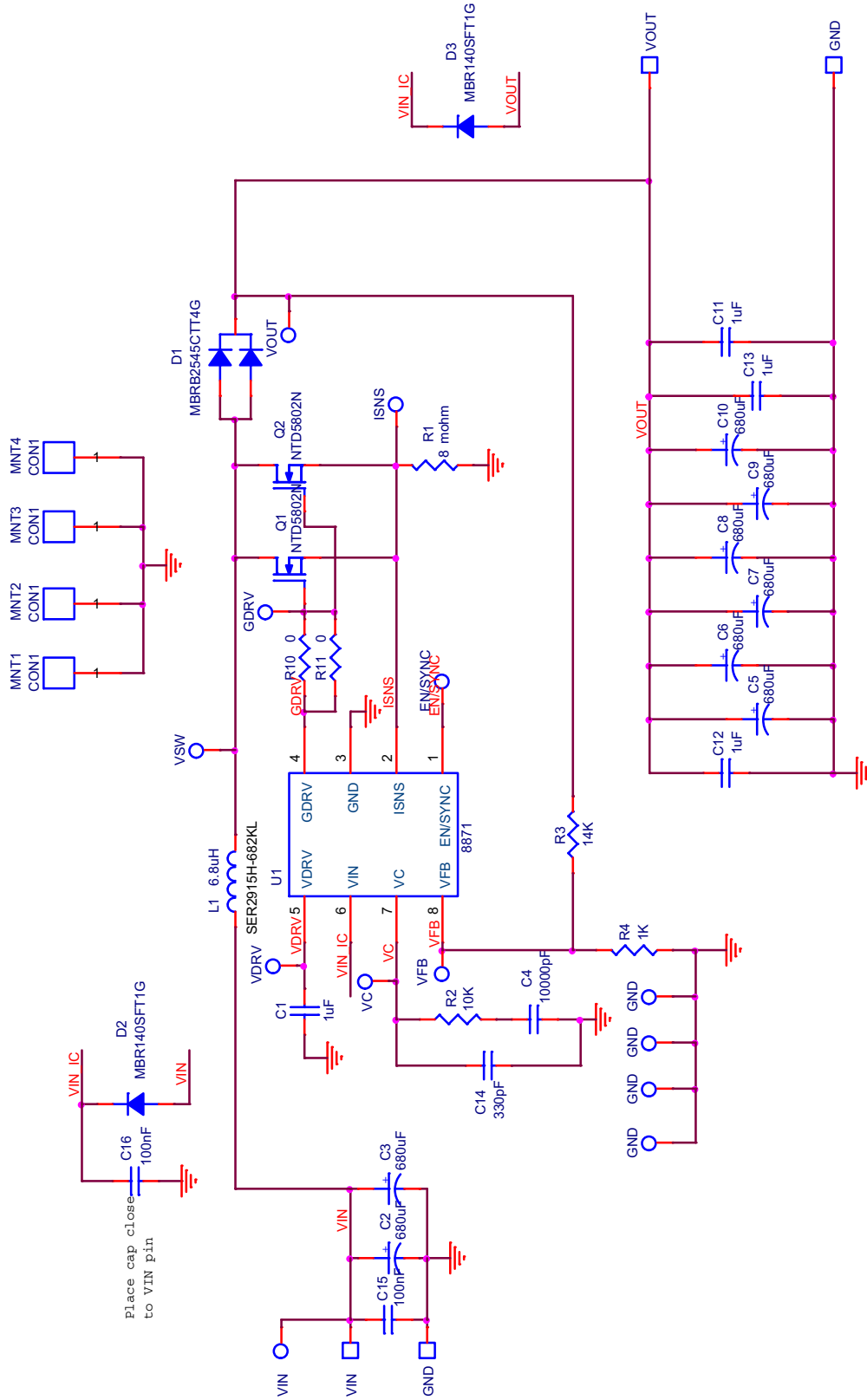

Figure 7. NCV8871BSTGEVB Evaluation Board Schematic

NCV8871BSTGEVB

PCB Layout

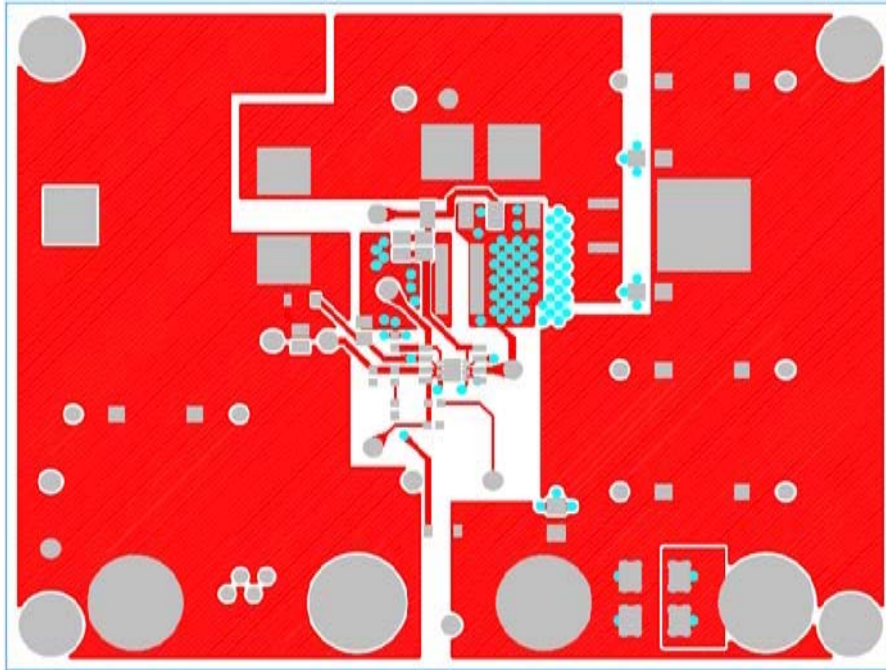

Figure 8. Top Layout

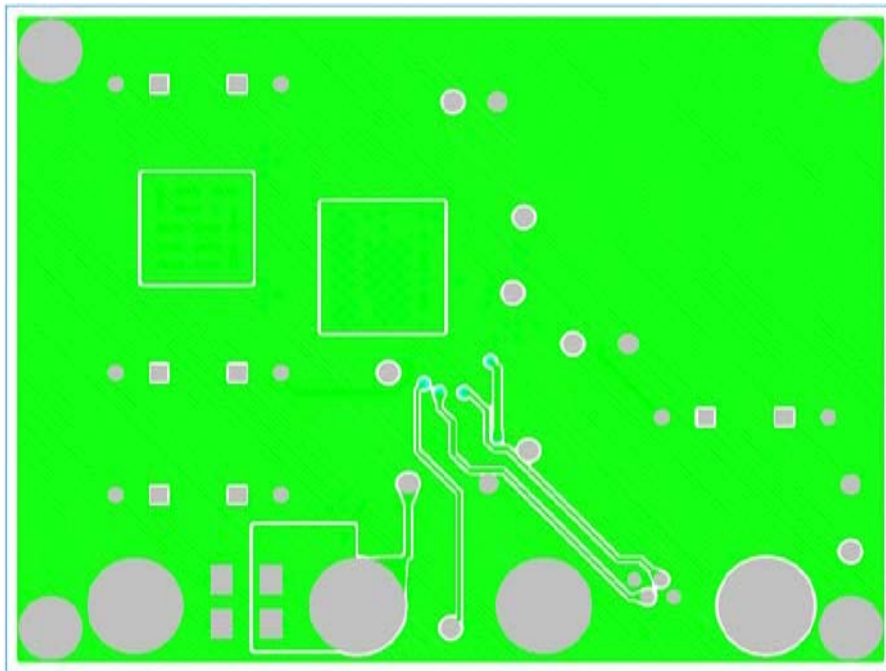



Figure 9. Bottom Layout

NCV8871BSTGEVB

Table 4. BILL OF MATERIALS

QTY	Description	Value	Tolerance	Footprint	Manufacturer	Manufacturer's Part Number	Substitution Allowed	RoHS Compliant
1	CAP CER 1UF 16V X7R 0603	1 uF	10%	603	Murata Electronics North America	GRM188R71C105KA12D	Yes	Yes
2	CAP ELECT 1000UF 50V FK SMD	1000 uF	20%	FKV_CAP	Panasonic - ECG	EEE-FK1H102AM	No	Yes
1	CAP CER 33000PF 50V X7R 0603	33000 pF	10%	603	Murata Electronics North America	GRM188R71H333KA61D	No	Yes
9	CAP 180UF 50V ELECT FM RADIAL	180 uF	20%	CAP_8P0	Murata Electronics North America	EEU-FM1H181L	No	Yes
3	CAP CER 1UF 50V X7R 1206	1 uF	10%	1206	Murata Electronics North America	GCM31MR71H105KA55L	Yes	Yes
1	CAP CER 2700PF 100V 10% X7R 0603	2700 pF	10%	603	Murata Electronics North America	GRM188R72A272KA01D	No	Yes
2	CAP CER .1UF 50V 10% X7R 0805	100 nF	10%	805	Murata Electronics North America	GRM21BR71H104KA01L	Yes	Yes
1	Do Not Populate			603			Yes	Yes
1	45V, 30A D2PAK Schottky Rectifier	45 V / 30 A	N/A	D2PAK_3	ON Semiconductor	MBRB2545CTT4G	No	Yes
2	DIODE SCHOTTKY 40V 1A SOD123FL	40 V / 1 A	N/A	SOD_123	ON Semiconductor	MBR140SFT1G	No	Yes
1	CONN HEADER 4POS R/A 1.5MM TIN	N/A	N/A	4PINCONN	Coilcraft Inc	292206-4	No	Yes
1	High Temp SMT Power Inductor 6.8uH	6.8 uH	30A	SER2900	Coilcraft Inc	SER2915H-682KL	No	Yes
2	MOSFET N-CH 40V 101A DPAK	40 V / 101 A	N/A	DPAK3_DMD	ON Semiconductor	NTD5802NT4G	No	Yes
1	RES 0.008 OHM 3W 1% 3015 SMD	0.008	1%	3015	Susumu	KRL7638-C-R008-F-T1	No	Yes
1	RES 6.34K OHM 1/10W 1% 0603 SMD	6.34 K	1%	603	Vishay/Dale	CRCW06036K34FKEA	Yes	Yes
1	RES 14.0K OHM 1/10W 1% 0603 SMD	14.0 K	1%	603	Vishay/Dale	CRCW060314K0FKEA	Yes	Yes
1	RES 1.00K OHM 1/10W 1% 0603 SMD	1.00 K	1%	603	Vishay/Dale	CRCW06031K00FKEA	Yes	Yes
2	RES 0.0 OHM 1/8W 0805 SMD	0	5%	805	Vishay/Dale	CRCW08050000Z0EA	Yes	Yes
13	PIN INBOARD .042" HOLE 1000/PKG	N/A	N/A	TP	Vector Electronics	K24C/M	Yes	Yes
4	CONN JACK BANANA UNINS PANEL MOU	N/A	N/A	BANANA	Emerson Network Power Conn Solutions	108-0740-001	No	Yes
1	Automotive Non-Sync Boost Controller	N/A	N/A	SO-IC8_N_ADJ	ON Semiconductor	NCV8871_00	No	Yes
1	Automotive Non-Sync Boost Controller	N/A	N/A	10PINDFNP5	ON Semiconductor	NCV8872_00	No	Yes
4	Hex Spacer 4-40 1/2" Zinc Plated Steel	N/A	N/A	MOUN-THOLE125	McMaster-Carr	93620A432	Yes	Yes
4	Hex Nut 4-40 1/4" Zinc Plated Steel	N/A	N/A	MOUN-THOLE125	McMaster-Carr	90480A005	Yes	Yes

NCV8871BSTGEVB

ON Semiconductor and  are trademarks of Semiconductor Components Industries, LLC dba ON Semiconductor or its subsidiaries in the United States and/or other countries. ON Semiconductor owns the rights to a number of patents, trademarks, copyrights, trade secrets, and other intellectual property. A listing of ON Semiconductor's product/patent coverage may be accessed at www.onsemi.com/site/pdf/Patent-Marking.pdf. ON Semiconductor reserves the right to make changes without further notice to any products herein. ON Semiconductor makes no warranty, representation or guarantee regarding the suitability of its products for any particular purpose, nor does ON Semiconductor assume any liability arising out of the application or use of any product or circuit, and specifically disclaims any and all liability, including without limitation special, consequential or incidental damages. Buyer is responsible for its products and applications using ON Semiconductor products, including compliance with all laws, regulations and safety requirements or standards, regardless of any support or applications information provided by ON Semiconductor. "Typical" parameters which may be provided in ON Semiconductor data sheets and/or specifications can and do vary in different applications and actual performance may vary over time. All operating parameters, including "Typicals" must be validated for each customer application by customer's technical experts. ON Semiconductor does not convey any license under its patent rights nor the rights of others. ON Semiconductor products are not designed, intended, or authorized for use as a critical component in life support systems or any FDA Class 3 medical devices or medical devices with a same or similar classification in a foreign jurisdiction or any devices intended for implantation in the human body. Should Buyer purchase or use ON Semiconductor products for any such unintended or unauthorized application, Buyer shall indemnify and hold ON Semiconductor and its officers, employees, subsidiaries, affiliates, and distributors harmless against all claims, costs, damages, and expenses, and reasonable attorney fees arising out of, directly or indirectly, any claim of personal injury or death associated with such unintended or unauthorized use, even if such claim alleges that ON Semiconductor was negligent regarding the design or manufacture of the part. ON Semiconductor is an Equal Opportunity/Affirmative Action Employer. This literature is subject to all applicable copyright laws and is not for resale in any manner.

PUBLICATION ORDERING INFORMATION

LITERATURE FULFILLMENT:

Literature Distribution Center for ON Semiconductor
P.O. Box 5163, Denver, Colorado 80217 USA
Phone: 303-675-2175 or 800-344-3860 Toll Free USA/Canada
Fax: 303-675-2176 or 800-344-3867 Toll Free USA/Canada
Email: orderlit@onsemi.com

N. American Technical Support: 800-282-9855 Toll Free
USA/Canada
Europe, Middle East and Africa Technical Support:
Phone: 421 33 790 2910
Japan Customer Focus Center
Phone: 81-3-5817-1050

ON Semiconductor Website: www.onsemi.com
Order Literature: <http://www.onsemi.com/orderlit>
For additional information, please contact your local
Sales Representative