

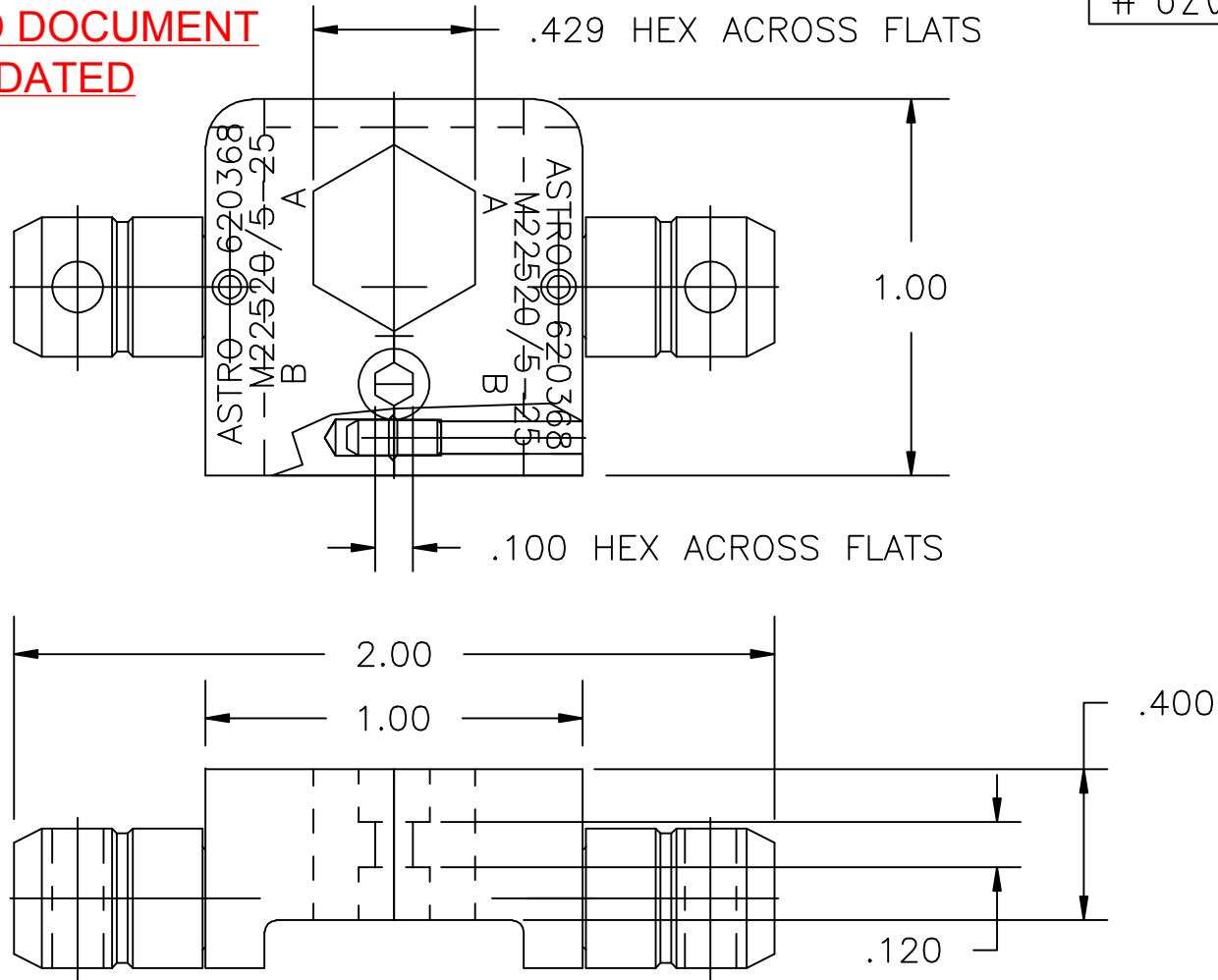

**UNCONTROLLED DOCUMENT  
WILL NOT BE UPDATED**

# 620368-ENV



NOTES: I. THIS IS AN AUTOCAD DRAWING DO NOT CHANGE MANUALLY.

					THESE DRAWINGS, SPECIFICATIONS OR OTHER DATA ARE AND REMAIN, THE PROPERTY OF ASTRO TOOL CORP. AND MUST BE RETURNED UPON REQUEST. THEY CONTAIN INFORMATION OWNED AND/OR DEVELOPED BY ASTRO AT ITS OWN PRIVATE EXPENSE AND MAY NOT BE USED, DUPLICATED OR DISCLOSED TO OTHERS, IN WHOLE OR IN PART FOR DESIGN, MANUFACTURE OR PROCUREMENT WITHOUT THE WRITTEN PERMISSION OF ASTRO TOOL CORP. EACH AND EVERY TIME.		SCALE: N.T.S. DWN BY: DYO DATE: 01-18-12 APPROVED:		UNLESS OTHERWISE SPECIFIED: DECIMALS: .XXX ± .005 .XX ± .010 .X ± .030 ANGLES: ± 1°		CAGE 58164  21615 S.W. TUALATIN VALLEY HWY., BEAVERTON OR 97006	
A	NEW RELEASE.	DYO	01-18-12	MMK	DESCRIPTION: ENVELOPE DRAWING: 620368 DIE SET, M22520/5-25		PART NO.		A	620368-ENV		
REV.	DESCRIPTION	BY	DATE	APR.								