

4

3

2

1

THIS DRAWING IS UNPUBLISHED. RELEASED FOR PUBLICATION 2010
 © COPYRIGHT 2010 BY TYCO ELECTRONICS CORPORATION. ALL RIGHTS RESERVED.

LOC	DIST	REVISIONS			
P	LTR	DESCRIPTION	DATE	DWN	APVD
E	B	BA	NEW RELEASE	19-FEB-10	MRS St.P

FOR FURTHER INFORMATION SEE DATA SHEET FOR
 SERIES LR, METAL FILM FIXED RESISTORS

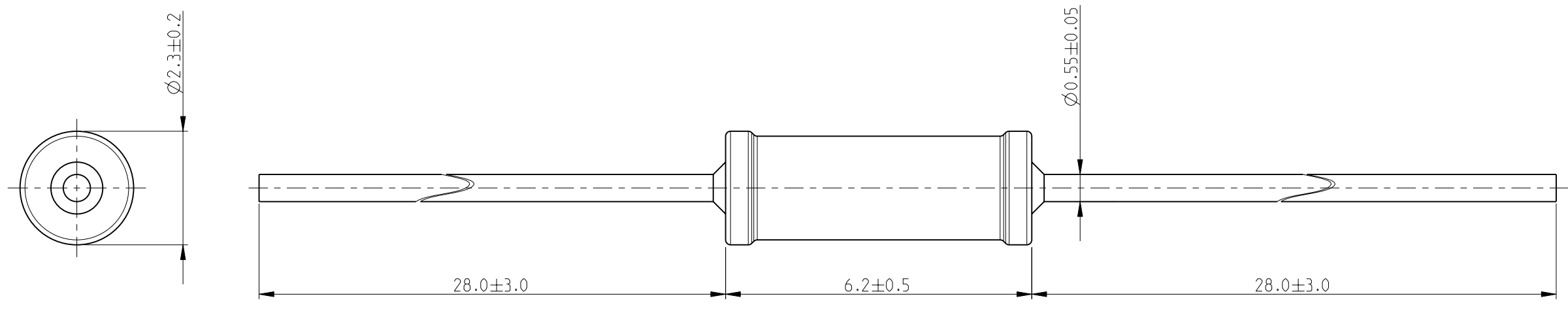

RoHS Compliant

<small>THIS DRAWING IS A CONTROLLED DOCUMENT FOR TYCO ELECTRONICS CORPORATION IT IS SUBJECT TO CHANGE AND THE CONTROLLING ENGINEERING ORGANIZATION SHOULD BE CONTACTED FOR THE LATEST REVISION.</small>		DWN MAHARUDRA 19-FEB-10 CHK ALLAN.P 19-FEB-10 APVD STEPHEN.P 19-FEB-10		Tyco Electronics Corporation Dorcan, Swindon, SN3 5HH	
DIMENSIONS: mm		TOLERANCES UNLESS OTHERWISE SPECIFIED: 0 PLC ± 0.2 1 PLC ± 0.1 2 PLC $\pm -$ 3 PLC $\pm -$ 4 PLC $\pm -$ ANGLES $\pm 5^\circ$		NAME METAL FILM FIXED RESISTORS SERIES LR1	
MATERIAL -		FINISH -		PRODUCT SPEC - APPLICATION SPEC - WEIGHT -	
CUSTOMER DRAWING				SIZE A3 CAGE CODE 00779 DRAWING NO C-1622383	RESTRICTED TO -
SCALE 10:1				SHEET 1 OF 1	REV BA