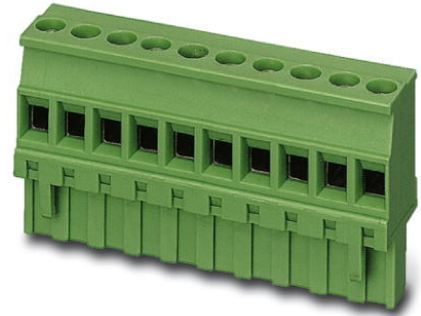

MVSTBR 2,5/ 7-ST

Order No.: 1792061

The figure shows a 10-position version of the product

<http://eshop.phoenixcontact.de/phoenix/treeViewClick.do?UID=1792061>

Plug component, Nominal current: 12 A, Nom. voltage: 250 V, Pitch:
5 mm, Number of positions: 7, Connection type: Screw connection,
Color: green

Commercial data

EAN	4017918044541
Pack	50 pcs.
Customs tariff	85366990
Weight/Piece	0.0152 KG
Catalog page information	Page 202 (CC-2009)

Product notes

WEEE/RoHS-compliant since:
01/01/2003

<http://www.download.phoenixcontact.com>
Please note that the data given here has been taken from the online catalog. For comprehensive information and data, please refer to the user documentation. The General Terms and Conditions of Use apply to Internet downloads.

Technical data

Dimensions / positions

Pitch	5 mm
Dimension a	30 mm
Number of positions	7
Screw thread	M3

Tightening torque, min	0.5 Nm
Tightening torque max	0.6 Nm

Technical data

Insulating material group	I
Rated surge voltage (III/3)	4 kV
Rated surge voltage (III/2)	4 kV
Rated surge voltage (II/2)	4 kV
Rated voltage (III/2)	320 V
Rated voltage (II/2)	630 V
Connection in acc. with standard	EN-VDE
Nominal current I_N	12 A
Nominal voltage U_N	250 V
Nominal cross section	2.5 mm ²
Maximum load current	12 A (with 2.5 mm ² conductor cross section)
Insulating material	PA
Inflammability class acc. to UL 94	V0
Internal cylindrical gage	A3
Stripping length	7 mm

Connection data

Conductor cross section solid min.	0.2 mm ²
Conductor cross section solid max.	2.5 mm ²
Conductor cross section stranded min.	0.2 mm ²
Conductor cross section stranded max.	2.5 mm ²
Conductor cross section stranded, with ferrule without plastic sleeve min.	0.25 mm ²
Conductor cross section stranded, with ferrule without plastic sleeve max.	2.5 mm ²
Conductor cross section stranded, with ferrule with plastic sleeve min.	0.25 mm ²
Conductor cross section stranded, with ferrule with plastic sleeve max.	2.5 mm ²
Conductor cross section AWG/kcmil min.	24
Conductor cross section AWG/kcmil max	12
2 conductors with same cross section, solid min.	0.2 mm ²
2 conductors with same cross section, solid max.	1 mm ²

2 conductors with same cross section, stranded min.	0.2 mm ²
2 conductors with same cross section, stranded max.	1.5 mm ²
2 conductors with same cross section, stranded, ferrules without plastic sleeve, min.	0.25 mm ²
2 conductors with same cross section, stranded, ferrules without plastic sleeve, max.	1 mm ²
2 conductors with same cross section, stranded, TWIN ferrules with plastic sleeve, min.	0.5 mm ²
2 conductors with same cross section, stranded, TWIN ferrules with plastic sleeve, max.	1.5 mm ²

Certificates / Approvals



Certification

CB, CSA, CUL, GOST, UL, VDE-PZI

CSA

Nominal voltage U_N	300 V
Nominal current I_N	10 A
AWG/kcmil	28-12

CUL

Nominal voltage U_N	300 V
Nominal current I_N	10 A
AWG/kcmil	30-12

UL

Nominal voltage U_N	300 V
Nominal current I_N	10 A
AWG/kcmil	30-12

Additional products

Item	Designation	Description
General		
0707154	DFK-MSTB 2,5/ 7-G	Plug component, Nominal current: 12 A, Nom. voltage: 320 V, Nom. voltage: 320 V, Pitch: 5 mm, Number of positions: 7, Color: green, Assembly: Direct mounting
1899896	EMSTBA 2,5/ 7-G	Header, Nominal current: 12 A, Nom. voltage: 250 V, Pitch: 5 mm, Number of positions: 7, Color: green, Assembly: Press-in
1914904	EMSTBVA 2,5/ 7-G	Header, Nominal current: 12 A, Nom. voltage: 200 V, Pitch: 5 mm, Number of positions: 7, Color: green, Assembly: Press-in
1762745	MDSTB 2,5/ 7-G1	Header, Nominal current: 10 A, Nom. voltage: 250 V, Pitch: 5 mm, Number of positions: 7, Color: green, Assembly: Soldering
1846564	MDSTBA 2,5/ 7-G	Header, Nominal current: 10 A, Nom. voltage: 250 V, Pitch: 5 mm, Number of positions: 7, Color: green, Assembly: Soldering
1762897	MDSTBV 2,5/ 7-G1	Header, Nominal current: 10 A, Nom. voltage: 250 V, Pitch: 5 mm, Number of positions: 7, Color: green, Assembly: Soldering
1845837	MDSTBVA 2,5/ 7-G	Header, Nominal current: 10 A, Nom. voltage: 250 V, Pitch: 5 mm, Number of positions: 7, Color: green, Assembly: Soldering
1754533	MSTB 2,5/ 7-G	Header, Nominal current: 12 A, Nom. voltage: 250 V, Pitch: 5 mm, Number of positions: 7, Color: green, Assembly: Soldering
1768231	MSTB 2,5/ 7-G-LA	Header, Nominal current: 12 A, Nom. voltage: 250 V, Pitch: 5 mm, Number of positions: 7, Assembly: Soldering
1755493	MSTBA 2,5/ 7-G	Header, Nominal current: 12 A, Nom. voltage: 250 V, Pitch: 5 mm, Number of positions: 7, Color: green, Assembly: Soldering
1770533	MSTBA 2,5/ 7-G-LA	Header, Nominal current: 12 A, Nom. voltage: 250 V, Pitch: 5 mm, Number of positions: 7, Assembly: Soldering
1753534	MSTBV 2,5/ 7-G	Header, Nominal current: 12 A, Nom. voltage: 250 V, Pitch: 5 mm, Number of positions: 7, Color: green, Assembly: Soldering
1755561	MSTBVA 2,5/ 7-G	Header, Nominal current: 12 A, Nom. voltage: 250 V, Pitch: 5 mm, Number of positions: 7, Color: green, Assembly: Soldering
1736069	MSTBW 2,5/ 7-G	Header, Nominal current: 12 A, Nom. voltage: 250 V, Pitch: 5 mm, Number of positions: 7, Color: green, Assembly: Soldering
1769285	SMSTB 2,5/ 7-G	Header, Nominal current: 12 A, Nom. voltage: 250 V, Pitch: 5 mm, Number of positions: 7, Color: green, Assembly: Soldering
1769858	SMSTBA 2,5/ 7-G	Header, Nominal current: 12 A, Nom. voltage: 250 V, Pitch: 5 mm, Number of positions: 7, Color: green, Assembly: Soldering

Diagrams/Drawings

Diagram

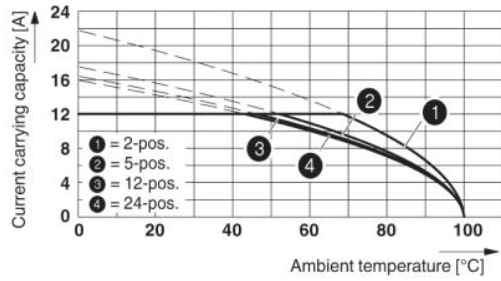

Type: MVSTBR 2,5/...-ST(5,08) with MSTBA 2,5/...-G(-5,08)

Dimensioned drawing

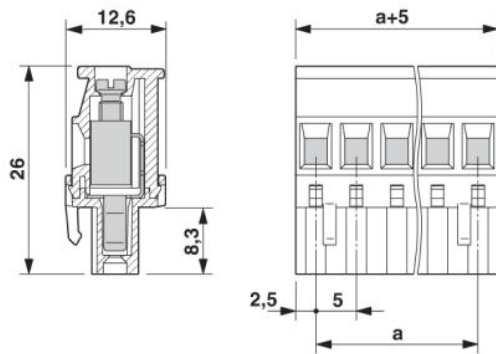

Address

PHOENIX CONTACT Inc., USA
586 Fulling Mill Road
Middletown, PA 17057, USA
Phone (800) 888-7388
Fax (717) 944-1625
<http://www.phoenixcon.com>



© 2010 Phoenix Contact
Technical modifications reserved;