

1N649-1

FEATURES

- 1N649-1 AVAILABLE IN JAN, JANTX, AND JANTXV PER MIL-PRF-19500/240
- SILICON RECTIFIER
- METALLURGICALLY BONDED
- HERMETICALLY SEALED
- DOUBLE PLUG CONSTRUCTION

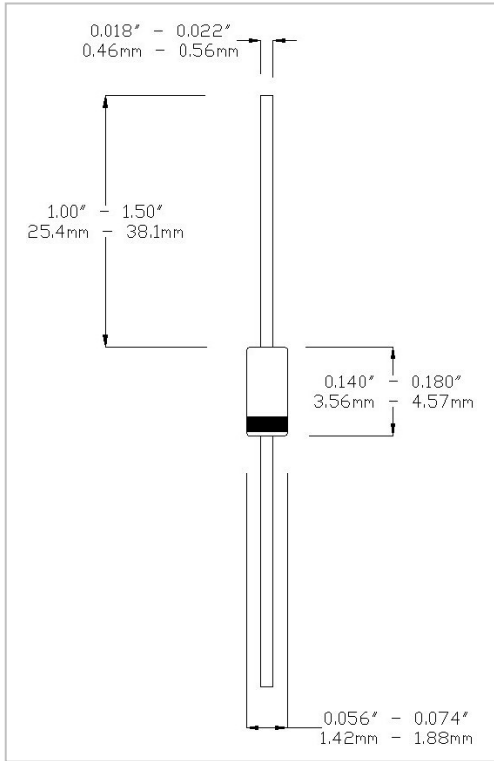

MAXIMUM RATINGS AT 25 °C

Operating Temperature:	-65°C to +175°C
Storage Temperature:	-65°C to +175°C
Surge Current A, sine 8.3mS:	5.0A
Total Power Dissipation:	500mW
Operating Current:	400mA, T _A = +25°C
Operating Current:	150mA, T _A = +150°C
Derating Factor:	2mA/°C above +25°C
Derating Factor:	6mA/°C above +150°C
D.C. Reverse Voltage (VRWM):	600V

DC ELECTRICAL CHARACTERISTICS

Ambient (°C)	V _F			I _R			
	I _F mA	Min V	Max V	Ambient (°C)	V _R V (dc)	Min μA	Max μA
25	400	0.80	1.00	25	600	-	0.050
150	400	0.70	0.95	25	720(ac)	-	50
-55	400	-	1.20	150	600	-	25

DESIGN DATA

Case: Hermetically sealed glass package per MIL-PRF-19500/240 DO-35 outline

Lead Material: Copper clad steel

Lead Finish: Tin/Lead

Thermal Resistance (R_{θJL}): 250°C/W maximum at L=.375"

Thermal Impedance (Z_{θJX}): 35°C/W maximum

Marking: Blue body coat, Black digits.

Polarity: Cathode end is banded.

AC ELECTRICAL CHARACTERISTICS AT 25°C

	Symbol	Min	Max
Capacitance @ V _R = 4V	pF	-	20



WWW.MICROSEMI.COM

IRELAND - GORT ROAD, ENNIS, CO. CLARE

PHONE: +353 65 6840044

TOLL FREE: +186 62 702434

FAX: +353 65 6822298

U.S.A. DOMESTIC SALES CONTACT

PHONE: (617) 926 0404

TOLL FREE: 1 800 666 2999