

DRH Series 3 Phase Solid State Contactors DIN Rail Mount

This installation sheet includes detailed mounting and wiring instructions which apply for Crydom DRH 3 Phase Solid State Contactors. Be sure to visit the product series' datasheet available at the Crydom website to complement this information. If you have questions or need additional information please contact Crydom Tech Support.

Please read all mounting instructions before using your DRH Series Solid State Contactor.

MOUNTING INSTRUCTIONS (A, B)

- Install the contactor on the DIN rail (as shown in **fig.1**).
- Wire the contactor to the input side. AWG #18 (0.8 mm²) minimum, AWG #12 (3.3 mm²) x 2 maximum.
- Wire the contactor to the output side. AWG #18 (0.8 mm²) minimum, AWG #10 (5.3 mm²) x 2 (stranded/solid) maximum.
- Maximum recommended terminal screw torque input 12 in-lb (1.36 Nm) & output 15 in-lb (1.7 Nm).
- If multiple units are installed be sure to follow derating curves

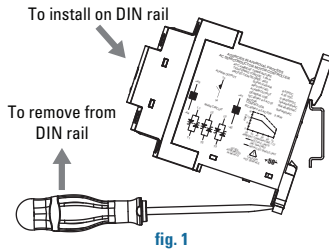

fig. 1

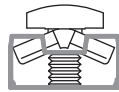

fig. 2 Terminal screw type. Top/Bottom view.

WARNING! Removing product from 35 mm rail incorrectly by not using the appropriate tool could damage the latching system.

TABLE 1. HP Ratings at Nominal Voltage

Ambient Temperature	DRH @ 480 VAC
40°C	5 HP / 3.7 kW
60°C	3 HP / 2.2 kW
80°C	1.5 HP / 1.1 kW

DERATING CURVES

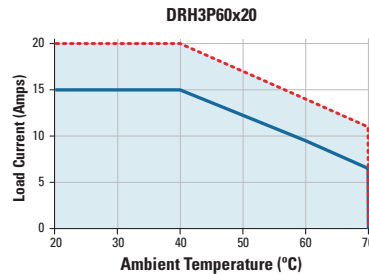
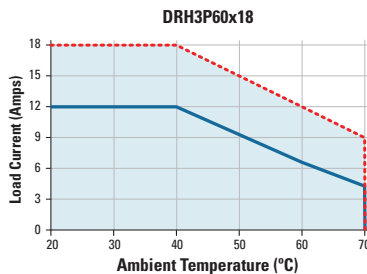

General Notes

- (A) See compatible accessories in corresponding datasheet.
- (B) For optimal thermal performance, contactor vents should be aligned vertically to maximize airflow.
- (C) On models with 2 controlled legs, L2 and T2 are linked internally.

PART NUMBER NOMENCLATURE

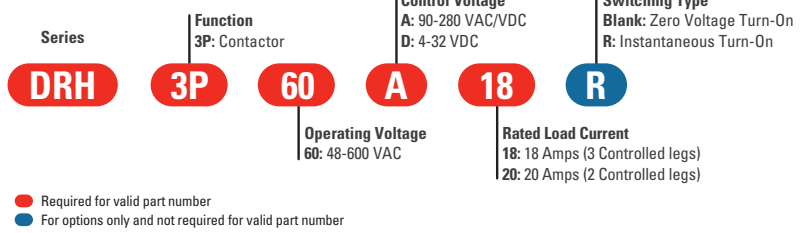

WIRING DIAGRAM (C)

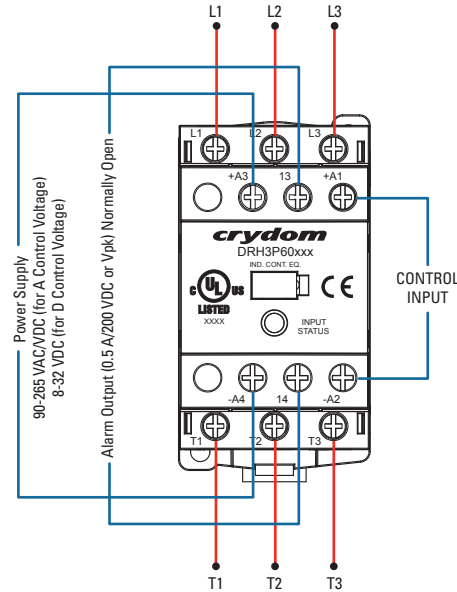

General Use / AC-51 Application

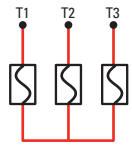

Motor Controller / AC-53a Application

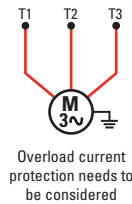

Important Considerations

Be sure to use input and output voltages within operating ranges.

LED indicates input and alarm status. It does not represent output status.

To achieve maximum ratings, there must be a minimum spacing of 0.9 in (22 mm) between the devices in free air. (See **fig. 3**)

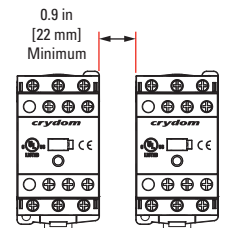
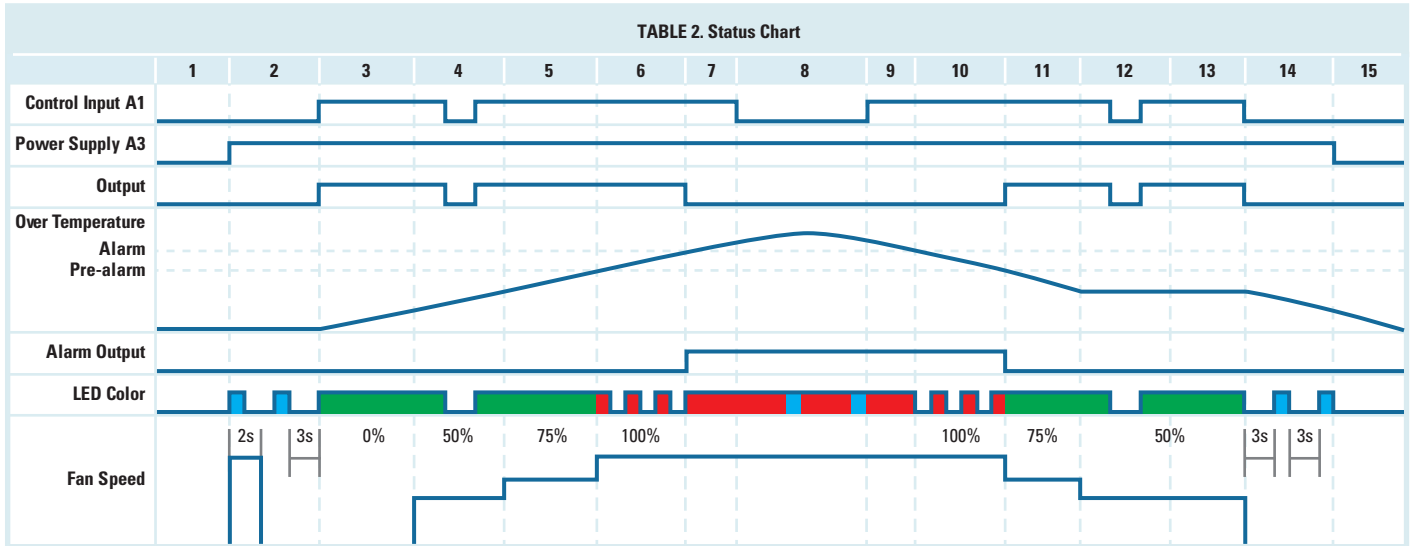

fig. 3 Multiple units mounting for maximum ratings

- Single unit, or multiple units with spacing greater than minimum (see **fig. 3**)
- Multiple units, no minimum spacing between components (see **fig. 3**)



Step	Description
1, 15	Initial Condition
2, 14	Stand by condition. LED is blinking Blue. Fan is activated at full speed for 2 seconds after power is applied to A3
3	A1 is On, Output is activated, temperature rises. LED is Green
4, 12	Fan is activated at 50% speed. If A1 is disabled, LED changes to blinking Blue
5, 11	Fan is at 75% speed
6, 10	LED changes to blinking Red, fan is at full speed
7	Output is Off, Alarm Output is On, LED changes to solid Red
8	If A1 is disabled while alarm output is active, LED alternates between Blue and Red
9	LED is solid Red, temperature starts to fall
13	Fan is activated at 50% speed, temperature is steady

LED Color



⚠ DANGER / DANGER / GEFARH / PELIGRO / PERICOLO / 危险		
<p>HAZARD OF ELECTRIC SHOCK, EXPLOSION OR ARC FLASH</p> <ul style="list-style-type: none"> Turn off power supply before working on this equipment. <p>Failure to follow these instructions will result in death or serious injury.</p>	<p>RISQUE D'ELECTROCUTION, D'EXPLOSION OU D'ARC ELECTRIQUE</p> <ul style="list-style-type: none"> Coupez l'alimentation avant de travailler sur cet appareil. <p>Le non-respect de ces instructions provoquera la mort ou des blessures graves.</p>	<p>STROMSCHLAG-, EXPLOSIONS- ODER LICHTBOGENGEFAHR</p> <ul style="list-style-type: none"> Vor dem Arbeiten an dem Gerät dessen Stromversorgung abschalten. <p>Die Nichtbeachtung dieser Anweisungen führt zu Tod oder schwerer Körperverletzung.</p>
<p>RIESGO DE ELECTROCUCIÓN, EXPLOSIÓN O ARCO ELÉCTRICO</p> <p>Desconecte toda alimentación antes de realizar el servicio.</p> <p>Si no se siguen estas instrucciones provocará lesiones graves o incluso la muerte.</p>	<p>RISCHIO DI SCOSSA ELETTRICA, DI ESPLOSIONE O DI OFTALMIA DA FLASH</p> <ul style="list-style-type: none"> Scollegare l'apparecchio dalla presa di corrente prima di qualsiasi intervento. <p>Il mancato rispetto di queste istruzioni provocherà morte o gravi infortuni.</p>	<p>存在电击、爆炸或电弧闪烁危险</p> <ul style="list-style-type: none"> 在操作此设备之前请先关闭电源。 <p>若不遵守这些说明，可能会导致严重的人身伤害甚至死亡。</p>

⚠ WARNING / AVERTISSEMENT / WARNUNG / ADVERTENCIA / AVVERTENZA / 警告		
<p>RISK OF MATERIAL DAMAGE AND HOT ENCLOSURE</p> <ul style="list-style-type: none"> The product's side panels may be hot, allow the product to cool before touching. Follow proper mounting instructions including torque values. Do not allow liquids or foreign objects to enter this product. <p>Failure to follow these instructions can result in serious injury, or equipment damage.</p>	<p>RISQUE DE DOMMAGE MATERIEL ET DE SURCHAUFFE DU BOITIER</p> <ul style="list-style-type: none"> Les panneaux latéraux du produit peuvent être chauds. Laisser le produit refroidir avant de le toucher. Respecter les consignes de montage, et notamment les couples de serrage. Ne pas laisser pénétrer de liquide ni de corps étrangers à l'intérieur du produit. <p>Le non-respect de cette directive peut entraîner, des lésions corporelles graves ou des dommages matériels.</p>	<p>GEFAHR VON MATERIALSCHÄDEN UND GEHÄUSEERHITZUNG</p> <ul style="list-style-type: none"> Die Seitenwände können heiß sein. Lassen Sie das Produkt abkühlen, bevor Sie es berühren. Beachten Sie die Montageanweisungen. Führen Sie keine Flüssigkeiten oder Fremdkörper in das Produkt ein. <p>Die Nichtbeachtung dieser Anweisung kann Körperverletzung oder Materialschäden zur Folge haben.</p>
<p>RIESGO DE DAÑOS MATERIALES Y DE SOBRECIENTAMIENTO DE LA UNIDAD</p> <ul style="list-style-type: none"> Los paneles laterales del producto pueden estar calientes. Esperar que el producto se enfríe antes de tocarlo. Respetar las instrucciones de montaje, y en particular los pares de apretado. No dejar que penetren líquidos o cuerpos extraños en el producto. <p>Si no se respetan estas precauciones pueden producirse graves lesiones, daños materiales.</p>	<p>RISCHIO DI DANNI MATERIALI E D'INVOLUCRO CALDO</p> <ul style="list-style-type: none"> I pannelli laterali dell'apparecchio possono scottare; lasciar quindi raffreddare il prodotto prima di toccarlo. Seguire le istruzioni di montaggio corrette. Non far entrare liquidi o oggetti estranei in questo apparecchio. <p>La mancata osservanza di questa precauzione può causare gravi rischi per l'incolumità personale o danni alle apparecchiature.</p>	<p>材料损坏和高温外壳的危险性</p> <ul style="list-style-type: none"> 产品的一侧面板可能很热，在其冷却前请不要触碰。 遵照正确的安装说明，包括扭矩值。 请勿让液体及其他异物进入本产品。 <p>如不能正确执行这些操作说明，极有可能造成严重人身伤害或者设备的损坏。</p>