

JENNY-CY

~105° 105° batwing light distribution for canopy and symmetrical tunnel lighting. Assembly with black holder.

TECHNICAL SPECIFICATIONS:

Dimensions	34.8+50 mm
Height	11.5 mm
Fastening	screw
Colour	clear
Box size	
Box weight	0 kg
Quantity in Box	1440 pcs
ROHS compliant	yes ⓘ



MATERIAL SPECIFICATIONS:

Component	Type	Material	Colour
JENNY-CY	Lens	Silicone	clear
JENNY-HLD-A-BLK	Accessory	PC	black

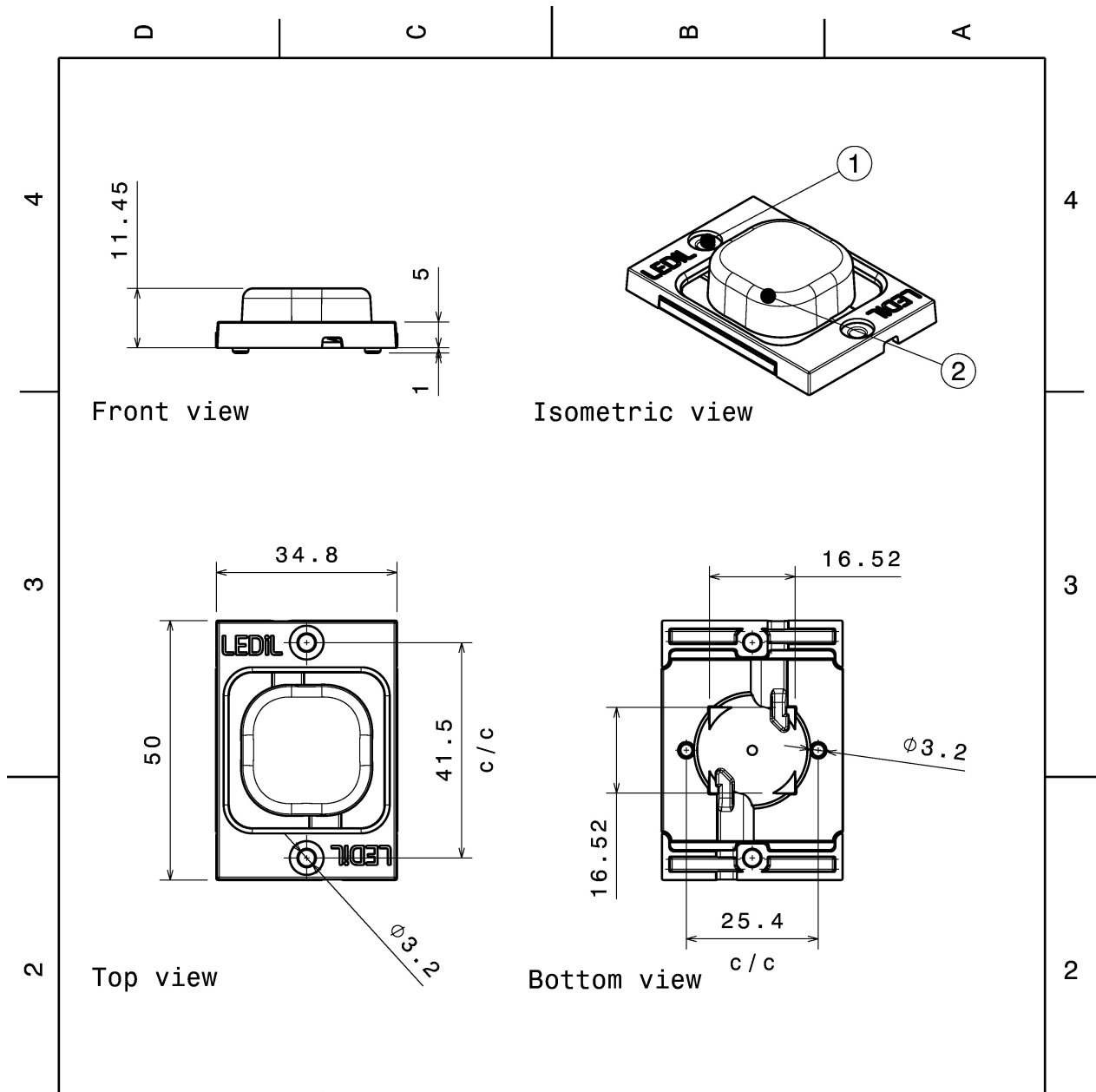

INDEX	PART NO	DESCRIPTION	MATERIAL	COLOUR
1	C14436	JENNY-HLD-A-BLK	PC	black
2	F14531	JENNY-CY	Optical grade LSR	clear

Tolerances if not otherwise shown
According to DIN ISO 2768-1
Linear measures: class V
Please note that due to the elasticity of
products made of silicone actual measured
values may vary, and therefore typical
tolerance values may not be applied.

LEDiL Ledil Oy
Salorankatu 10
FIN 24240 SALO
Finland

THIRD ANGLE PROJECTION:



DRAWING TITLE
FCN14648_JENNY-CY

This drawing is the property
of LEDiL Oy. It may not be
reproduced, copied or
communicated without a written
agreement with LEDiL Oy.

SIZE	PART NUMBER
A4	FCN14648

SCALE	1:1	WEIGHT	9,02 g	SHEET	1/1
-------	-----	--------	--------	-------	-----

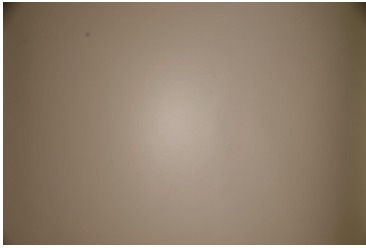
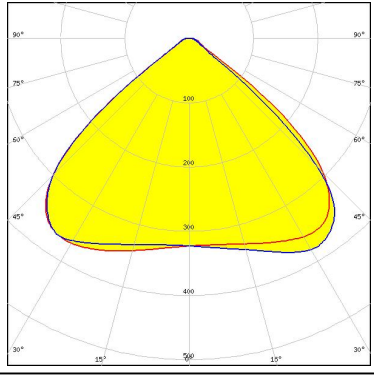
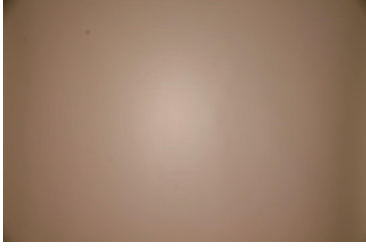
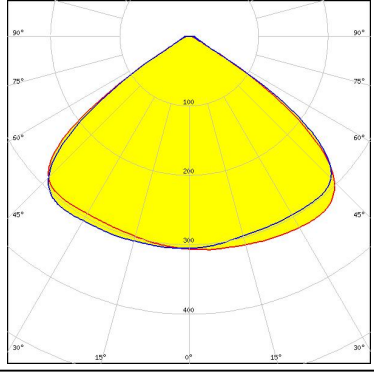
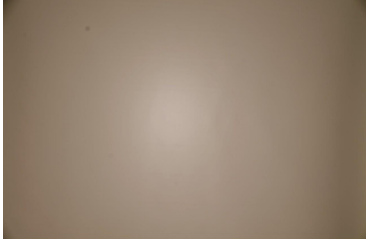
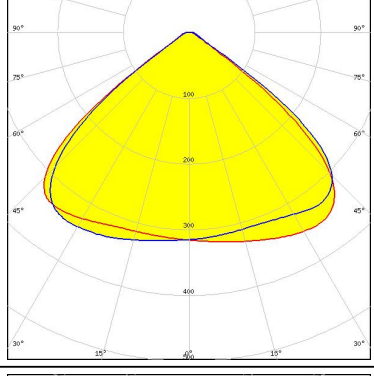
PHOTOMETRIC DATA (MEASURED):

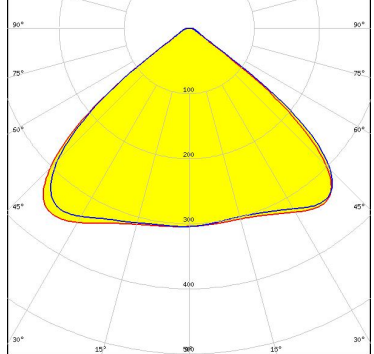
<p>bridgelux.</p> <p>LED V10 Gen6 FWHM 103.0 + 101.0° Efficiency 94 % Peak intensity 0.430 cd/lm Required components:</p>		
<p>bridgelux.</p> <p>LED V6 Gen6 FWHM 110.0° Efficiency 94 % Peak intensity 0.350 cd/lm Required components:</p>		
<p>bridgelux.</p> <p>LED V8 Gen6 FWHM 105.0 + 106.0° Efficiency 94 % Peak intensity 0.400 cd/lm Required components:</p>		
<p>CITIZEN</p> <p>LED CLL01x FWHM 104.0° Efficiency 94 % Peak intensity 0.443 cd/lm Required components:</p>		

PHOTOMETRIC DATA (MEASURED):

CITIZEN

LED CLL02x/CLU02x (LES10)
FWHM 103.0°
Efficiency 93 %
Peak intensity 0.400 cd/lm
Required components:

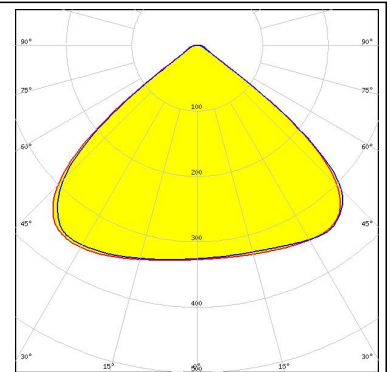
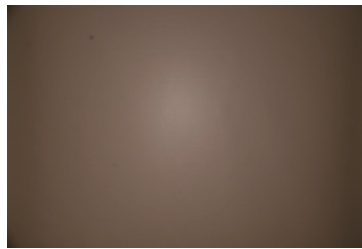

CITIZEN

LED CLU700/701
FWHM 102.0°
Efficiency 93 %
Peak intensity 0.470 cd/lm
Required components:

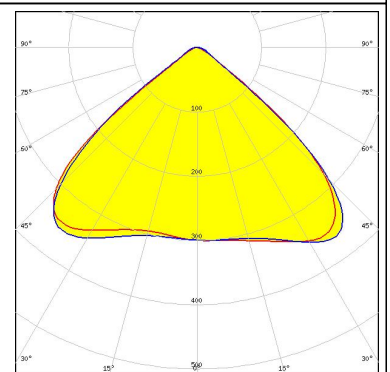
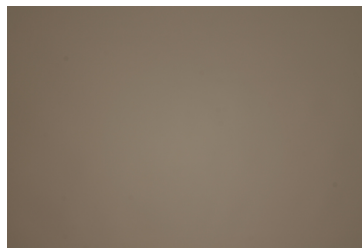

CREE

LED CXA/B 13xx
FWHM 105.0°
Efficiency 94 %
Peak intensity 0.410 cd/lm
Required components:

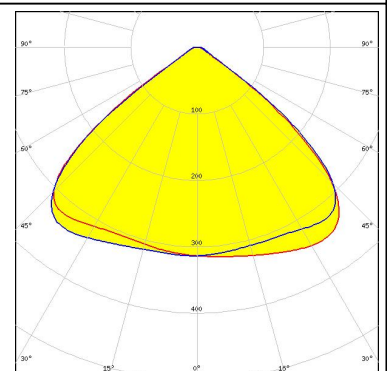
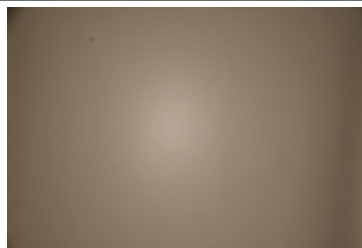

CREE

LED MK-R
FWHM 105.0°
Efficiency 92 %
Peak intensity 0.420 cd/lm
Required components:

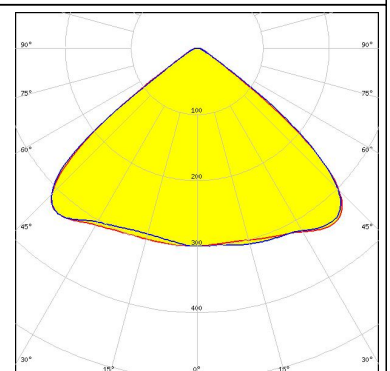
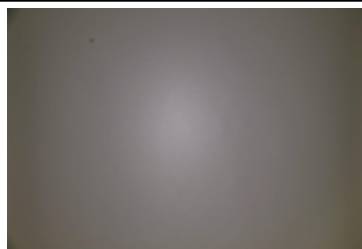

PHOTOMETRIC DATA (MEASURED):



LED XHP50
FWHM 105.0°
Efficiency 94 %
Peak intensity 0.420 cd/lm
Required components:

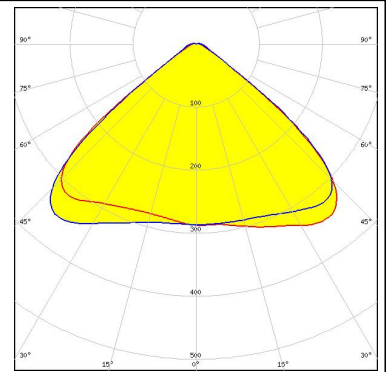
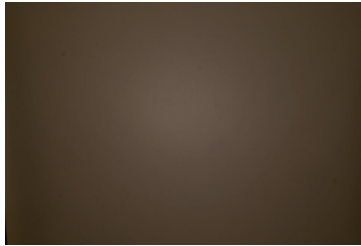

LED XM-L EZW
FWHM 102.0 + 103.0°
Efficiency 94 %
Peak intensity 0.460 cd/lm
Required components:

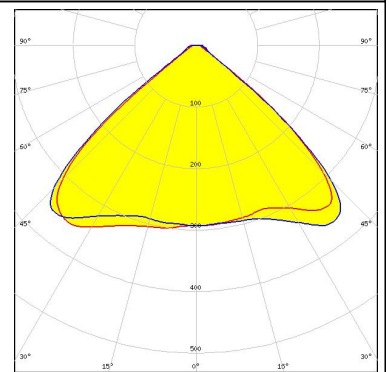
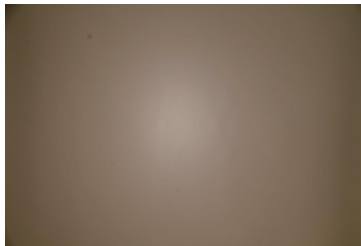

LED LUXEON 5258
FWHM 103.0 + 104.0°
Efficiency 94 %
Peak intensity 0.490 cd/lm
Required components:

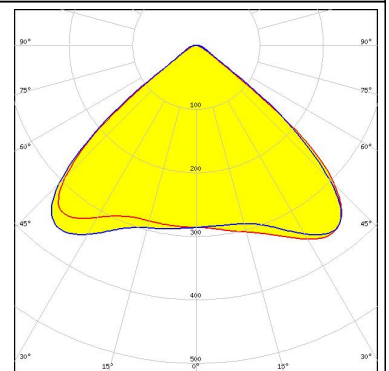
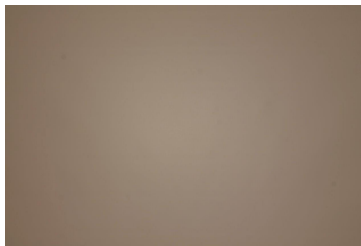

LED LUXEON M/MX
FWHM 105.0°
Efficiency 94 %
Peak intensity 0.450 cd/lm
Required components:

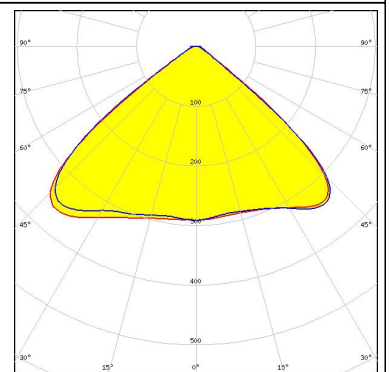
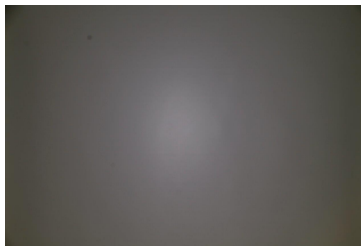

PHOTOMETRIC DATA (MEASURED):



LED NSMx286M
FWHM 105.0 + 104.0°
Efficiency 94 %
Peak intensity 0.410 cd/lm
Required components:

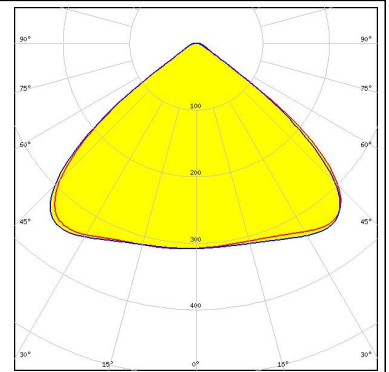
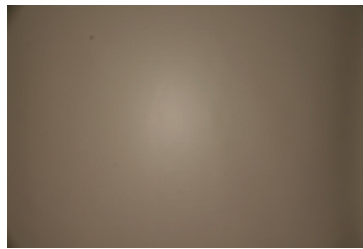

LED NV4x144A
FWHM 107.0°
Efficiency 92 %
Peak intensity 0.460 cd/lm
Required components:

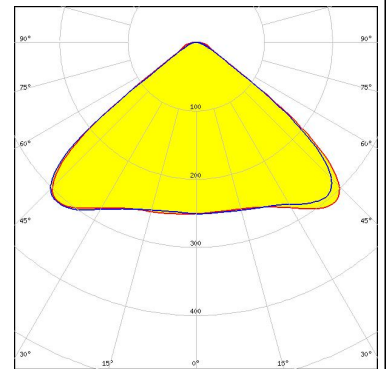

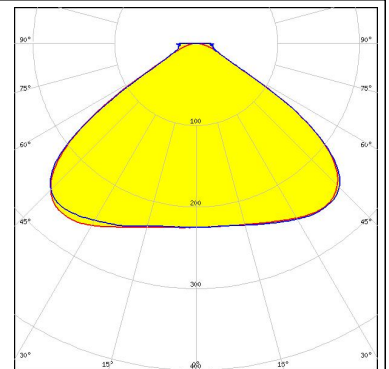

LED NV9W149AM
FWHM 115.0°
Efficiency 88 %
Peak intensity 0.340 cd/lm
Required components:



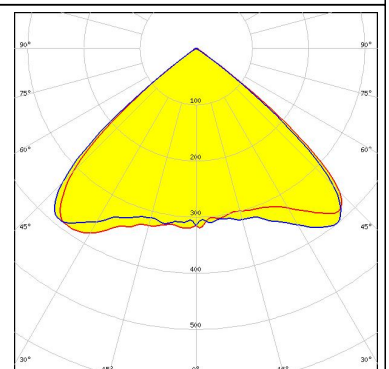
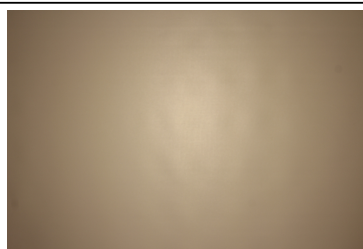

LED Duris S10
FWHM 108.0°
Efficiency 94 %
Peak intensity 0.350 cd/lm
Required components:

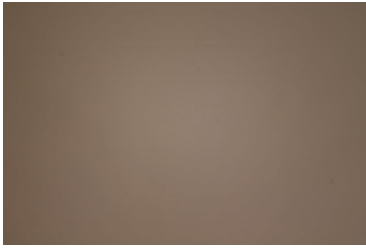
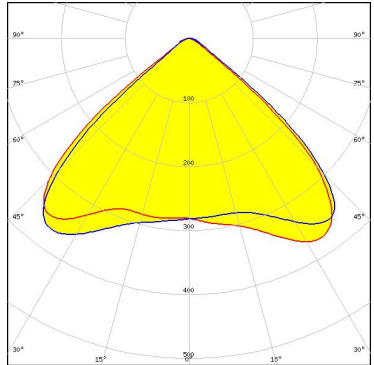
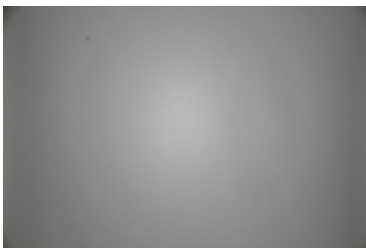
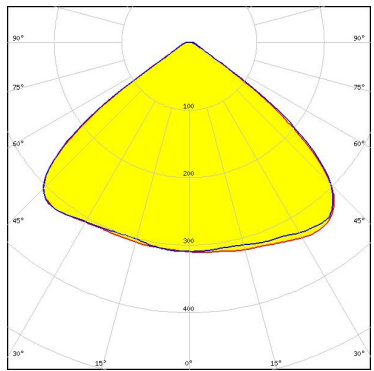

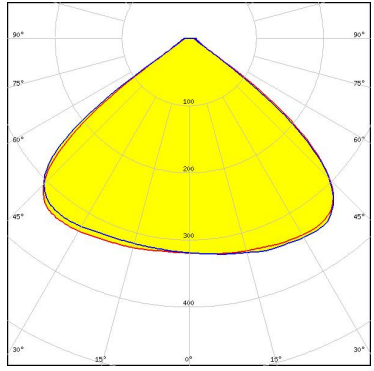
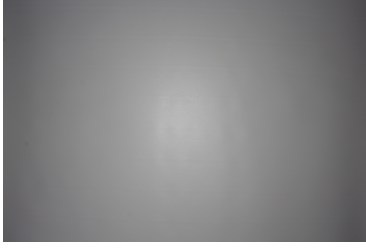
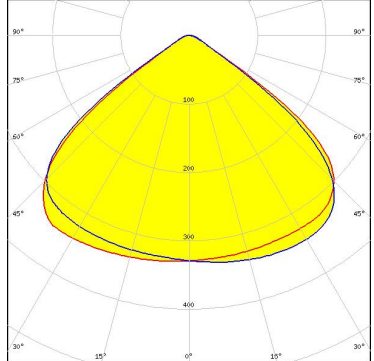
PHOTOMETRIC DATA (MEASURED):

<p>OSRAM Opto Semiconductors</p> <p>LED Duris S8 FWHM 102.0° Efficiency 94 % Peak intensity 0.520 cd/lm Required components:</p>		
<p>OSRAM Opto Semiconductors</p> <p>LED Soleriq P6 FWHM 106.0 + 107.0° Efficiency 94 % Peak intensity 0.400 cd/lm Required components:</p>		
<p>OSRAM Opto Semiconductors</p> <p>LED Soleriq P9 FWHM 106.0° Efficiency 94 % Peak intensity 0.390 cd/lm Required components:</p>		
<p>SAMSUNG</p> <p>LED COB D Series LES 9.8 mm FWHM 106.0° Efficiency 94 % Peak intensity 0.370 cd/lm Required components:</p>		

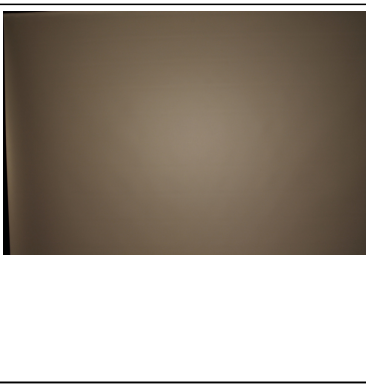
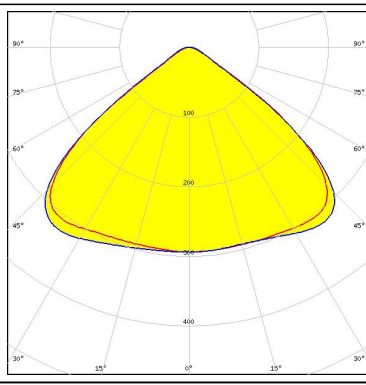
PHOTOMETRIC DATA (MEASURED):

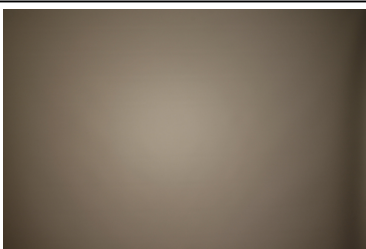
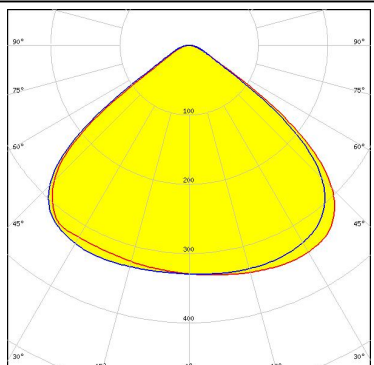
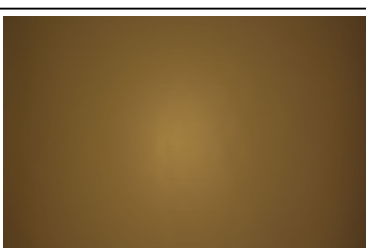
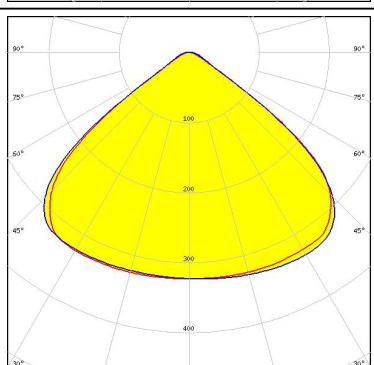
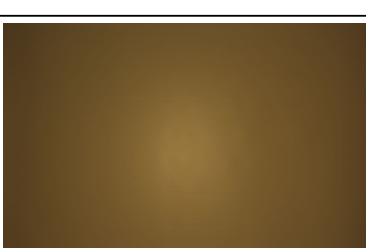
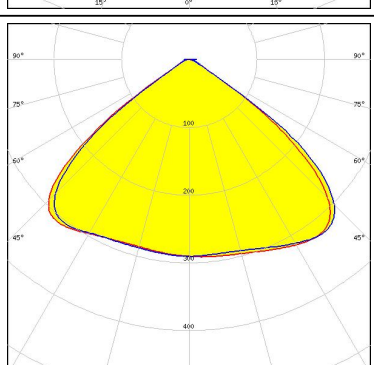
<p> SEOUL SEMICONDUCTOR</p> <p>LED MJT COB LES 6 FWHM 111.0° Efficiency 91 % Peak intensity 0.360 cd/lm Required components:</p>		
<p> SEOUL SEMICONDUCTOR</p> <p>LED MJT COB LES 9.8 FWHM 105.0° Efficiency 93 % Peak intensity 0.360 cd/lm Required components:</p>		
<p>TRIDONIC</p> <p>LED SLE G5 LES11 FWHM 106.0° Efficiency 91 % Peak intensity 0.350 cd/lm Required components:</p>		
<p>TRIDONIC</p> <p>LED SLE G5 LES6 FWHM 108.0° Efficiency 93 % Peak intensity 0.400 cd/lm Required components:</p>		

PHOTOMETRIC DATA (SIMULATED):



LED V10 Gen7
FWHM 95.0 + 102.0°
Efficiency 94 %
Peak intensity 0.390 cd/lm
Required components:

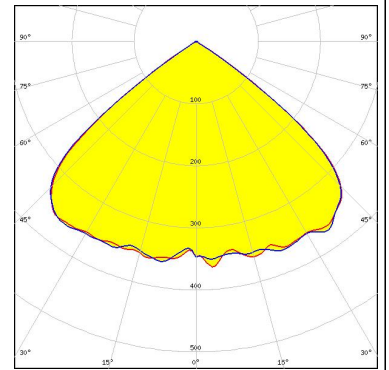

LED XHP50.2
FWHM 104.0°
Efficiency 94 %
Peak intensity 0.500 cd/lm
Required components:

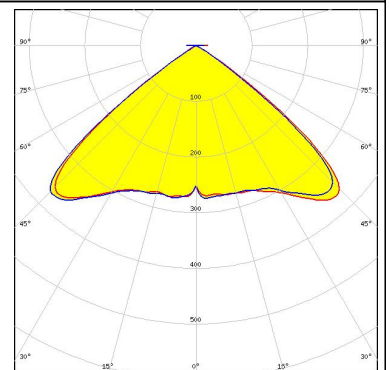

LED LUXEON 5050
FWHM 100.0°
Efficiency 94 %
Peak intensity 0.550 cd/lm
Required components:

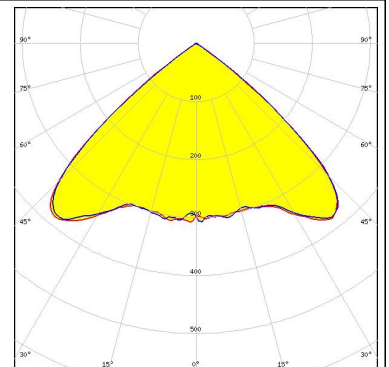

LED OSCONIQ P 7070
FWHM 100.0°
Efficiency 93 %
Peak intensity 0.540 cd/lm
Required components:

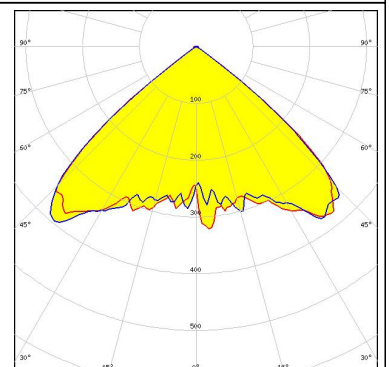

GENERAL INFORMATION:

NOTE: The typical beam angle will be changed by different color, chip size and chip position tolerance. The typical total beam angle is the full angle measured where the luminous intensity is half of the peak value.

Due to use of high power COB's with this product, special attention to proper thermal design is highly recommended. LEDiL has no liability for direct, indirect or consecutive damages arising from the LEDiL products being used outside of the recommended temperature range.

MATERIALS:

As part of our continuous research and improvement processes, and to ensure the best possible quality and availability of our products, LEDiL reserves the right to change material grades without notice.

PRODUCT DATA USER AGREEMENT AND DISCLAIMER:

The measured data in the provided downloadable LEDiL Product Datasheets and Mechanical 2D-Drawings is rounded and provided as reference for planning. LEDiL Oy's optical specifications have been verified by conducting performance testing of the products in accordance with the company's quality system. The reported data are averaged results of multiple measurements with typical variation. LEDiL Oy reserves the right to without prior notification make changes and improvements to its products.

LEDiL Oy assumes neither warranty, nor guarantee nor any other liability of any kind for the contents and correctness of the provided data. The provided data has been generated with highest diligence but the provided data may in reality not represent the complete possible variation range of all intrinsic parameters. Therefore, in certain cases a deviation from the provided data could occur.

LEDiL Oy reserves the right to undertake technical changes of its products without further notification which could lead to changes in the provided data. LEDiL Oy assumes no liability of any kind for the possible deviation from any provided data or any other damage resulting from the usage of the provided data.

The user agrees to this disclaimer and user agreement with the download or usage of the provided files.

LEDiL Oy

Joensuunkatu 13
FI-24240 SALO
Finland

LEDiL Inc.

228 West Page Street
Suite D
Sycamore IL 60178
USA

Local sales and technical support

www.ledil.com/where_to_buy

Shipping locations

Salo, Finland
Hong Kong, China

Distribution Partners

www.ledil.com/where_to_buy