

General Description

The MAX11300PMB1 peripheral module (Pmod™) provides the necessary hardware to interface the MAX11300 20-channel programmable mixed-signal I/O device to any system that utilizes Pmod-compatible expansion ports configurable for SPI communication. The device is a 12-bit multichannel analog-to-digital converter (ADC) and a 12-bit buffered DAC output in a single IC. This device also includes software-configurable general-purpose I/O ports. A local and two remote temperature sensors keep track of junction and environmental temperatures. Adjacent pairs of ports can also be used as logic translator or analog switch. Each pin can also be used as a positive input of a comparator with programmable threshold.

Refer to the MAX11300 IC data sheet for detailed information regarding operation of the device and the USB2PMB1 (Munich) adapter board data sheet for detailed information regarding the Munich board and GUI. Refer to the MAX11300 peripheral module and Munich adaptor board *Quick Start Guide* for step-by-step evaluation instructions. Refer to the MAX11300 Configuration Software User Guide for detailed information using the design tool.

Features and Benefits

- Up to 20 12-Bit ADC Programmable Inputs
- Up to 20 12-Bit DACs with 25mA Current Capability
 - 70mA max at +12V with On-Board Power Supply
 - Use External Power Supply at VDDIO (VDDIO Jumper Removed) if More Current is Needed
- Up to 20 Digital I/Os
- Up to 20 Comparator Inputs
- Internal or External Reference for ADC and DAC
- Individually Selectable ADC References for Each Port
- Internal Temperature Sensor (-40°C to +125°C, ±3°C Accuracy)
- Two Remote Temperature-Measurement Controllers (-40°C to +150°C, ±3°C Accuracy)
- 2x6-Pin Pmod-Compatible Connector (SPI)
- RoHS Compliant
- Proven PCB Layout
- Fully Assembled and Tested

Peripheral Module Board Photo

[Ordering Information](#) appears at end of data sheet.

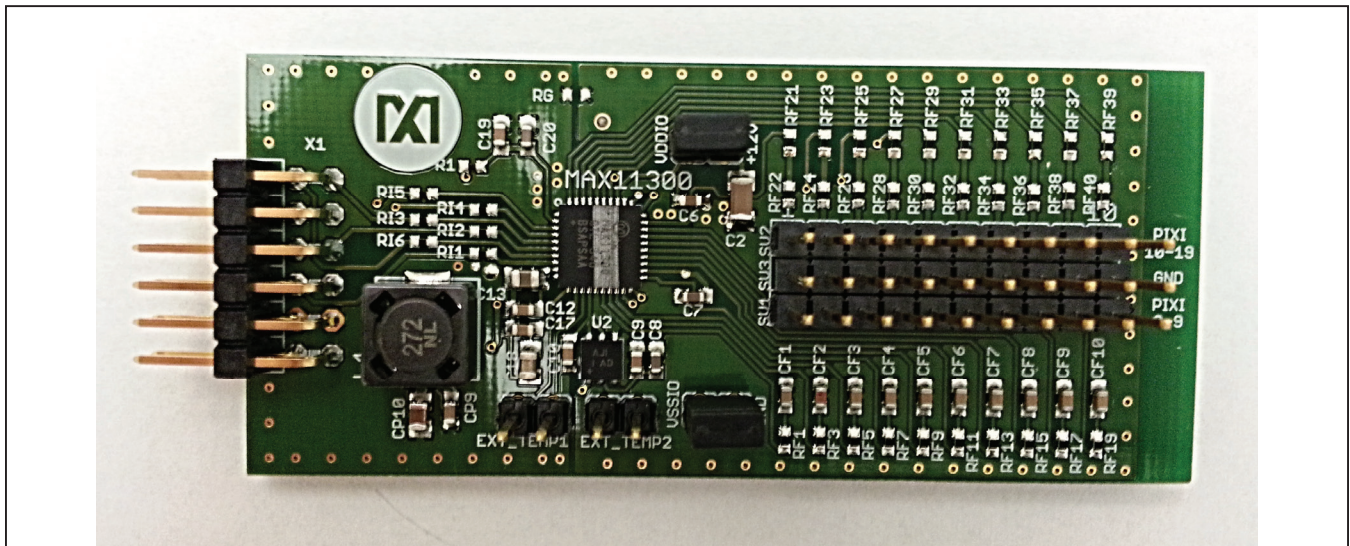

Pmod is a trademark of Digilent Inc.

Detailed Description

SPI Interface

The MAX11300PMB1 Pmod can plug directly into a Pmod-compatible port (configured for SPI) through the X1 connector. For information on the SPI protocol, refer to the MAX11300 IC data sheet.

- Connector X1 provides connection of the module to the Pmod host. See [Table 1](#) and [Figure 1](#) for detailed description.
- Connectors SV1 and SV2 provide connection to the IC pins (MAX11300 ports 0–19). Connector SV3 is ground.
- Connectors EXT_TEMP1 and EXT_TEMP2 provide connection to the external temperature sensors.
- Connector VDDIO provides connection to the AVDDIO pins of the device, which is connected to the +12V power supply
- Connector VSSIO provides connection to the AVSSIO pins of the device, which is the analog negative supply for mixed-signal ports. Install the VSSIO jumper to connect AVSSIO to ground.

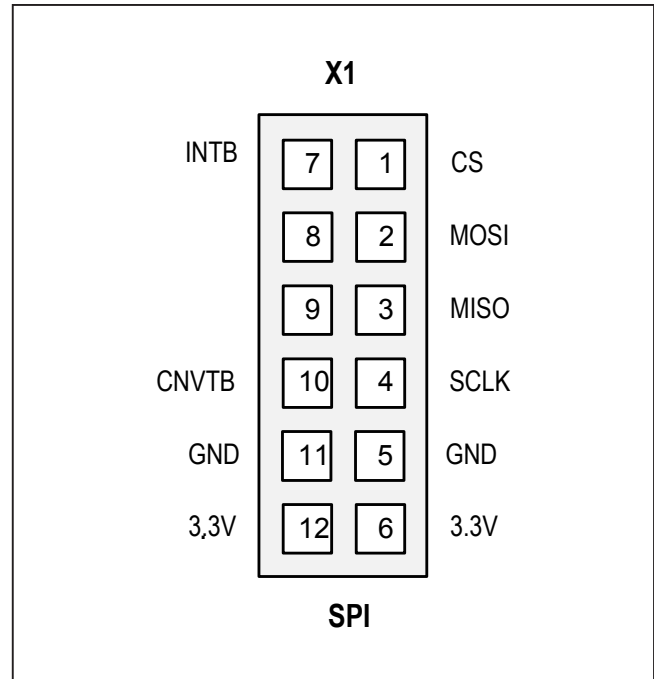

Figure 1. X1: Pmod SPI Connector Pin Configuration

Table 1. Connector X1 (SPI Communication)

PIN	SIGNAL	DESCRIPTION
1	CS	Chip Select. Assert low to enable the SPI interface.
2	MOSI	MAX11300 Serial Data Input
3	MISO	MAX11300 Serial-Data Output
4	SCLK	MAX11300 Serial-Clock Input
5, 11	GND	Ground
6, 12	+3.3V	+3.3V Power Supplies
7	INTB	Interrupt Open-Drain Output. Asserted low when the MAX11300 issues an interrupt.
8	—	No Connection
9	—	No Connection
10	CNVTB	ADC Conversion Control Input. Assert low to initiate an ADC conversion.

Default Jumper Setting

Verify that all jumpers are in their default positions, as follows:

- 1) Jumper VDDIO: Connect from VDDIO to +12V
- 2) Jumper VSSIO: Connect from VSSIO to GND
- 3) Jumpers EXT_TEMP1 and EXT_TEMP2: Open

Power Supplies

The Pmod contains the MAX8752 step-up DC-DC converter (U3), which upconverts the +3.3V power supply from the Pmod X1 connector to +13V. The MAX5084 (U2) linear regulator then regulates the +13V input to +5V output voltage, providing power supply to the positive analog supply AVDD of the IC. Another MAX5084 (U1) provides a +12V power supply to the positive analog supply of the mixed-signal ports (AVDDIO) of the IC. For bipolar applications, use an external power supply to provide negative voltage for AVSSIO. See [Figure 2](#).

Software Graphical User Interface (GUI)

The Munich software GUI is provided to facilitate evaluation of the Pmod.

Visit www.maximintegrated.com/evkitsoftware to download the latest version of the Munich GUI software. Refer to the MAX11300PMB1 peripheral module and Munich (USB2PMB1) adapter board *Quick Start Guide* for step-by-step evaluation using the Munich GUI.

External Power Supply

The on-board power supply provides 70mA max current at VDDIO = +12V. If additional current is needed, use an external power supply by removing the jumper connecting VDDIO to +12V and connecting a +12V external power supply to the VDDIO pin.

For bipolar applications, remove the jumper from VSSIO pin to GND and connect a negative power supply to the VSSIO pin. See [Figure 2](#) and refer to the MAX11300 IC data sheet for details.

External Temperature Sensors

Two-pin connector vertical headers, EXT_TEMP1 and EXT_TEMP2, are provided to measure the environment temperature. Connect the base and collector of diode-connected transistors, such as the 2N3906 to the TEMP1 or TEMP2 pin and the emitter to the EXT pin to measure the external temperature. See [Figures 3](#) and [4](#).

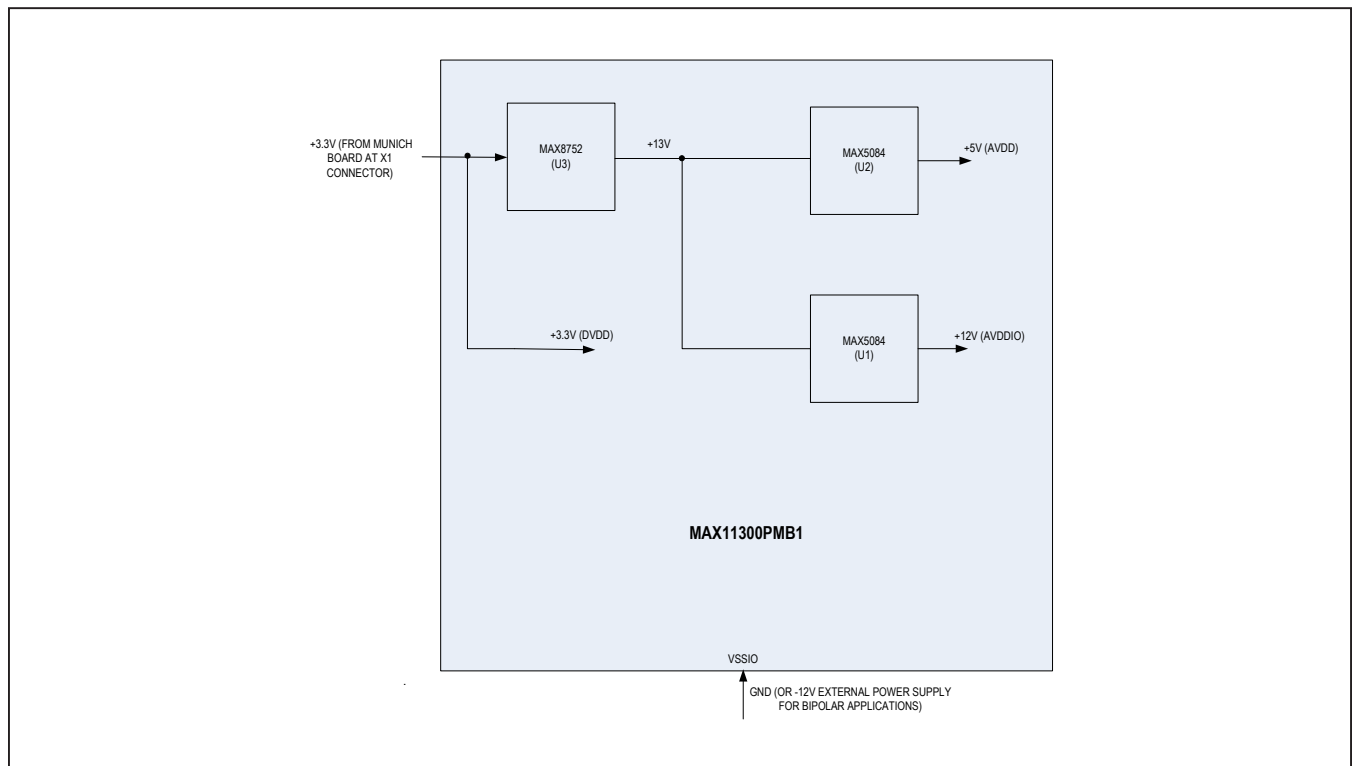

Figure 2. Power-Supply Block Diagram

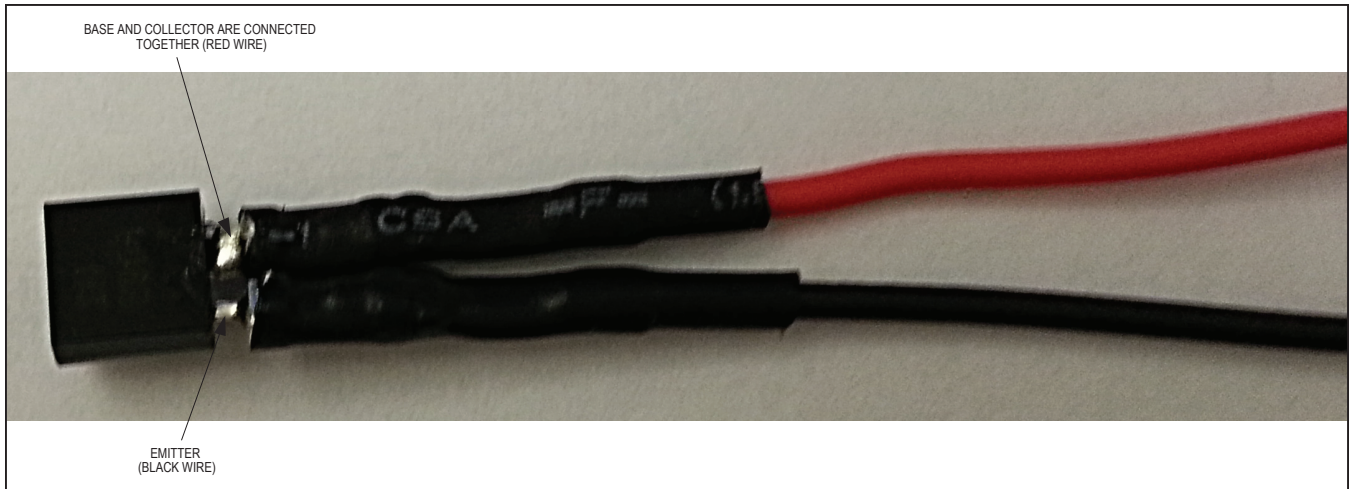

Figure 3. 2N3906 Diode-Connected Transistor Assembly (Not Included)

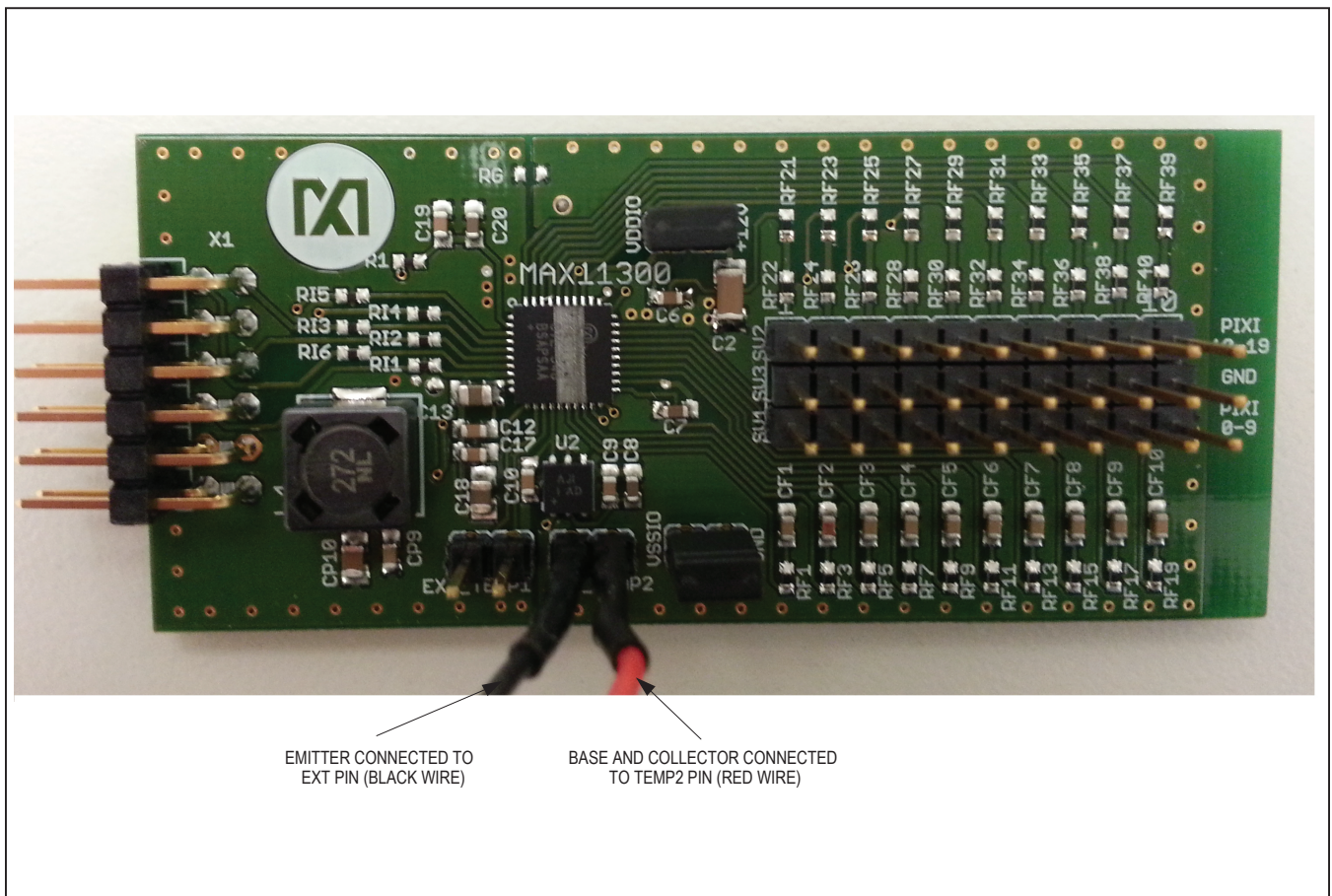

Figure 4. External Temperature Sensor Using Diode-Connected Transistor (Not Included)

Component List

DESIGNATION	QTY	DESCRIPTION
CF1–CF20 (Note 1)	20	10nF ±10%, 25V XR7 ceramic capacitors (0603) TDK C1608X7R1H103K080AA
CP1, CP5, CP10 (Note 2)	3	10µF ±20%, 16V XR5 ceramic capacitors (0805) TDK C2012X5R1C106M085AC
CP2, CP8, CP9, C4, C6, C9, C10, C12, C16, C17, C19	11	0.1µF ±10%, 25V XR7 ceramic capacitors (0603) TDK C1608X7R1E104K080AA
CP3	1	2.2µF ±10%, 16V XR5 ceramic capacitor (0603) TDK C1608X5R1C225K080AB
CP4	1	220nF ±10%, 16V XR7 ceramic capacitor (0603) TDK C1608X7R1C224K080AC
CP6	1	22PF ±5%, 50V NPO ceramic capacitor (0603) TDK C1608C0G1H220J080AA
CP7	1	1200pF ±5%, 50V CH ceramic capacitor (0603) TDK C1608CH1H122J080AA
C1, C2, C5, C15	4	10µF ±20%, 25V JB ceramic capacitors (1206) TDK C3216JB1E106M085AC
C3, C7, C8, C11, C14, C20	6	1µF ±10%, 25V XR5 ceramic capacitors (0603) TDK C1608X5R1E105K080AC
C13, C18	2	4.7µF ±10%, 16V XR5 ceramic capacitors (0805) TDK C2012X5R1C475K125AC
EXT_TEMP1, EXT_TEMP2, VDDIO, VSSIO	4	2-pin connector vertical headers, .100 15AU TE Connectivity 87224-2

DESIGNATION	QTY	DESCRIPTION
D1	1	40V, 2A Schottky diode Panasonic DB2141300L
L1	10	2.7µH power shielded inductor Pulse Electronics P1167.272NLT
RF1–RF40	40	47Ω ±5% resistors (0402) (Note 1)
RG	0	0Ω resistor (0402)
RI1–RI6	6	22Ω ±1% resistors (0402) (Note 3)
R1, R4	2	100Ω ±5% resistors (0402)
R2, R5	1	100kΩ ±5% resistors (0402)
R3	1	12kΩ ±1% resistor (0402)
R6	1	10kΩ ±1% resistor (0402)
R7	20	40.2kΩ ±1% resistor (0402)
SV1–SV3	3	10-pin connector headers, vertical, .100 15AU TE Connectivity 1-87224-0
U1, U2	2	65V, 200mA low-quiescent current linear regulators (6 TDFN-EP*) Maxim MAX5084ATT+
U3	1	Step-up DC-DC converter (8 TDFN-EP*) Maxim MAX8752ETA+
U4	1	20-channel programmable mixed-signal I/O with 12-bit ADC, 12-bit DAC, and GPIO (40 TQFN) Maxim MAX11300GTL+
X1	1	12-pin connector header, .100 R/A, 15AU FC1 68021-212HLF

*EP = Exposed pad.

Note 1: CF_ and RF_ are configured as lowpass filters.

Note 2: CP_ are bypass capacitors for the charge-pump step-up converter, MAX8752.

Note 3: RI_ are series SPI interface resistors to reduce glitches.

Component Suppliers

SUPPLIER	PHONE	WEBSITE
Pulse Electronics	858 674 8100	www.pulseelectronics.com
TDK Corp.	847-803-6100	www.component.tdk.com
TE Connectivity	610-893-9800	www.te.com

Note: Indicate that you are using the MAX11300PMB1 when contacting these component suppliers.

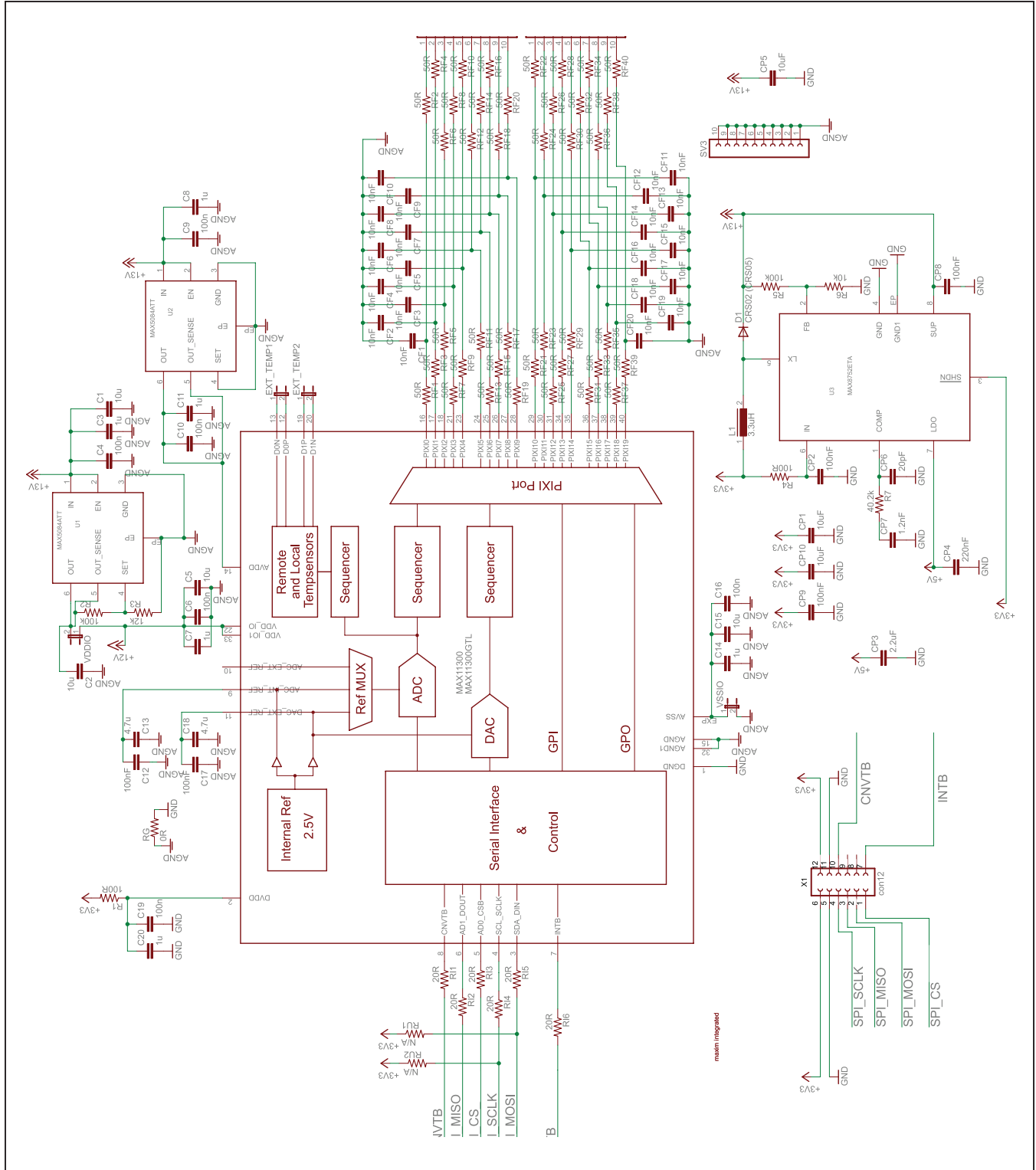

Figure 5. MAX11300PMB1 Peripheral Module Schematic

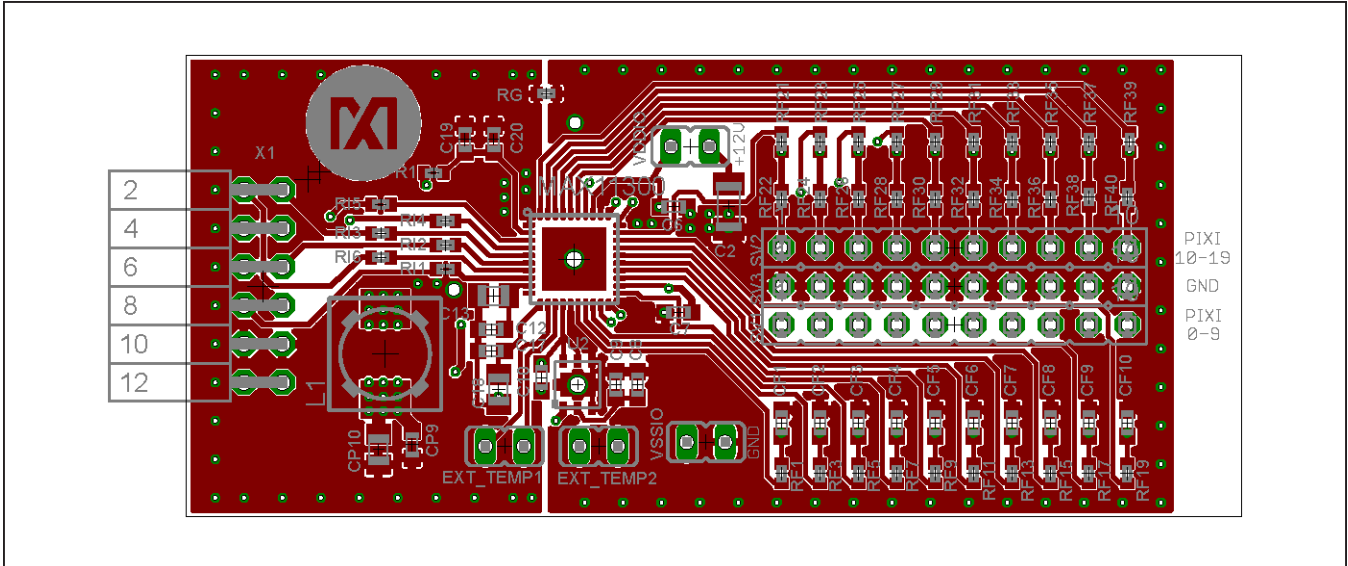

Figure 6. MAX11300 Peripheral Module Component Placement Guide—Top

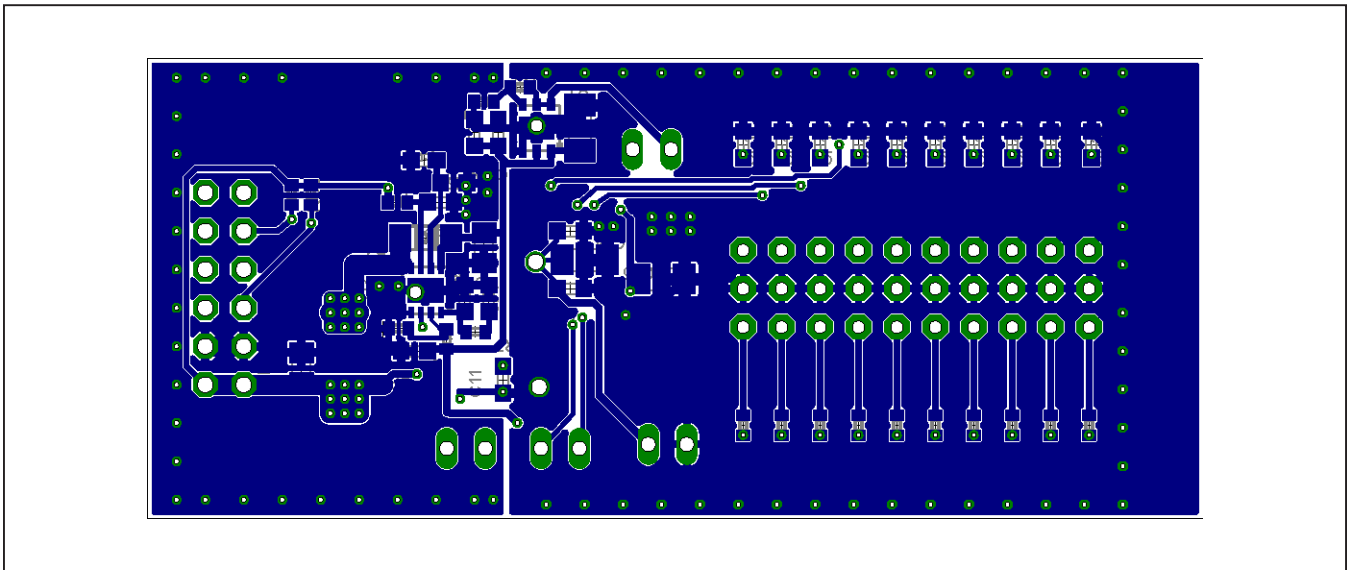

Figure 7. MAX11300PMB1 Peripheral Module Component Placement Guide—Bottom

Ordering Information

PART	TYPE
MAX11300PMB1#	Peripheral Module
USB2PMB1#	Munich Adapter Board
MAX11300SYS1#	Peripheral Module and Munich Adapter Board

#Denotes RoHS compliant.

Revision History

REVISION NUMBER	REVISION DATE	DESCRIPTION	PAGES CHANGED
0	2/14	Initial release	—
1	4/14	Added new sections for <i>Default Jumper Setting</i> , <i>External Power Supply</i> , <i>External Temperature Sensors</i> ; added new figures 1–4 and replaced Figure 5; updated <i>Component List</i>	2–4
2	6/14	Updated <i>Ordering Information</i>	1

For pricing, delivery, and ordering information, please contact Maxim Direct at 1-888-629-4642, or visit Maxim Integrated's website at www.maximintegrated.com.

Maxim Integrated cannot assume responsibility for use of any circuitry other than circuitry entirely embodied in a Maxim Integrated product. No circuit patent licenses are implied. Maxim Integrated reserves the right to change the circuitry and specifications without notice at any time.