

## Change the Sensing Direction Freely

- Change the sensing direction from front to back. Adjustable up, down, left and right, in 90° units.
- Mounts like a Limit Switch.







 Be sure to read *Safety Precautions* on page 5.





## Ordering Information

### Sensors

#### DC Models

Appearance	Sensing distance	Model	
		Output configuration NPN NO + NC (both outputs)	Output configuration PNP NO + NC (both outputs)
Shielded 	 20 mm	E2Q2-N20E3-H	E2Q2-N20F3-H
Unshielded 	 30 mm	E2Q2-N30ME3-H	E2Q2-N30MF3-H

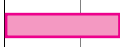
#### AC Models

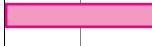
Appearance	Sensing distance	Model
		Operation mode NO/NC (selectable)
Shielded 	 15 mm	E2Q2-N15Y4-H
Unshielded 	 30 mm	E2Q2-N30MY4-H

### Accessories (Order Separately)

The recommended cable clamp is the ST Model manufactured by K.MECS Co., Ltd.

Product number	Screw size	SW	C	D	Applicable cable outer diameter
ST-M20 × 1.5	M20 × 1.5	25	37	9	7 to 13

#### Applicable seal packing

GPM20

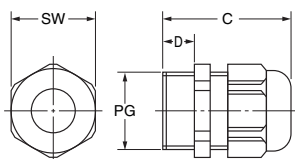

For purchasing details, contact the sales company.  
Contact information is provided below.

#### K.MECS Co.,Ltd.

Yusen Iwamotocho Bldg. 3F  
2-3-3 Iwamotocho, Chiyodaku, Tokyo, Japan 101-0032.

Telephone: +81-3-5825-5333  
Facsimile: +81-3-5825-8550

## Ratings and Specifications

Item	Shielding Model	Shielded	Unshielded	Shielded	Unshielded
		E2Q2-N20□3-H	E2Q2-N30M□3-H	E2Q2-N15Y4-H	E2Q2-N30MY4-H
Sensing distance		20 mm±10%	30 mm±10%	15 mm±10%	30 mm±10%
Set distance		0 to 16 mm	0 to 24 mm	0 to 12 mm	0 to 24 mm
Differential travel		15% max. of sensing distance			
Sensing object		Ferrous metal (The sensing distance decreases with non-ferrous metal. Refer to <i>Engineering Data</i> on page 3.)			
Standard sensing object		Iron, 60 × 60 × 1 mm	Iron, 90 × 90 × 1 mm	Iron, 60 × 60 × 1 mm	Iron, 90 × 90 × 1 mm
Response frequency		150 Hz	100 Hz	20 Hz	
Power supply voltage (operating voltage range)		12 to 48 VDC (10 to 60 VDC), ripple (p-p): 10% max.		24 to 240 VAC (20 to 253 VAC), 50/60 Hz	
Current consumption/ Leakage current		20 mA max.		1.7 mA max Refer to <i>Engineering Data</i> on page 3.	
Control output	Switching capacity	200 mA max.		8 to 500 mA	
	Residual voltage	3 V max. with a 200 mA load current		Refer to <i>Engineering Data</i> on page 3.	
Indicators		Power indicator (green) Detection indicator (yellow)		Power indicator (green) Operation indicator (yellow)	
Operation mode (with sensing object approaching)		E3 Models: NPN NO+NC F3 Models: PNP NO+NC Refer to the timing charts under <i>I/O Circuit Diagrams</i> on page 4 for details.		AC: NO or NC (selectable) Refer to the timing charts under <i>I/O Circuit Diagrams</i> on page 4 for details.	
Protection circuits		Reverse polarity protection, load short-circuit protection		---	
Ambient temperature		Operating: -25 to 70°C (with no icing or condensation) Storage: -40 to 70°C (with no icing or condensation)			
Ambient humidity		Operating: 35% to 85% (with no condensation) Storage: 35% to 95% (with no condensation)			
Temperature influence	Shielded model	±10% max. of sensing distance at 23°C in the temperature range of -25 to 70°C			
	Unshielded model	±15% max. of sensing distance at 23°C in the temperature range of -25 to 70°C			
Voltage influence		±2% max. of sensing distance at within a range of ±10% of rated power supply voltage			
Insulation resistance		50 MΩ min. (at 500 VDC) between current-carrying parts and case			
Dielectric strength		E□ Model and F□ Model: 1,000 VAC, 50/60 Hz for 1 min. between current-carrying parts and case			
		Y Model: 4,000 VAC, 50/60 Hz for 1 min. between current-carrying parts and case			
Vibration resistance (destruction)		10 to 55 Hz, 1.5-mm double amplitude for 2 hours each in X, Y, and Z directions			
Shock resistance (destruction)		500 m/s <sup>2</sup> 10 times each in X, Y, and Z directions			
Degree of protection		IEC IP67 *			
Connection method		Terminal block			
Weight		Approx. 240 g			
Materials	Case	Polybutylene terephthalate (PBT)			
	Terminal block	Polybutylene terephthalate (PBT)			
	Sensing surface	Polybutylene terephthalate (PBT)			

\*When the recommended cable clamp is used.

Engineering Data (Reference Value)

Sensing Area

Shielded Models

E2Q2-N20□3-H

E2Q2-N15Y4-H

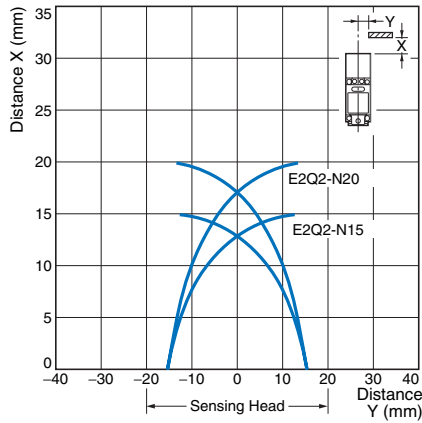

Unshielded Models

E2Q2-N30M□□-H

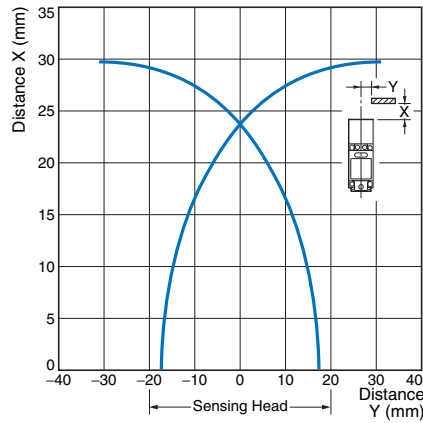

Leakage Current

E2Q2-N□Y4-H

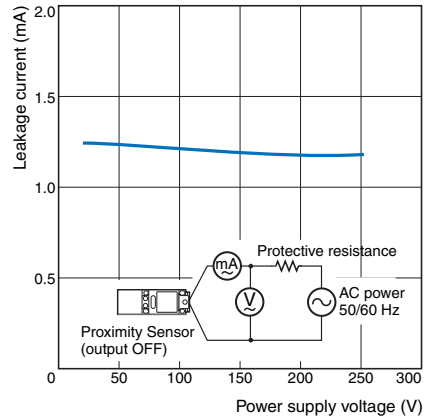

Influence of Sensing Object Size and Material

E2Q2-N20□3-H

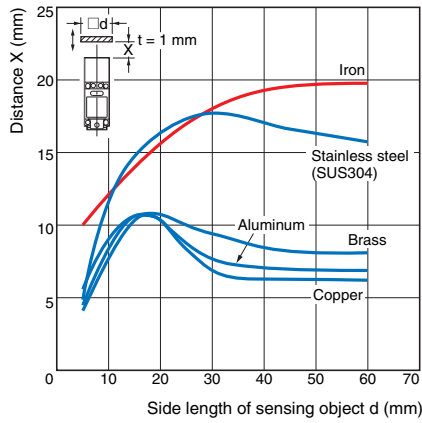

E2Q2-N15Y4-H

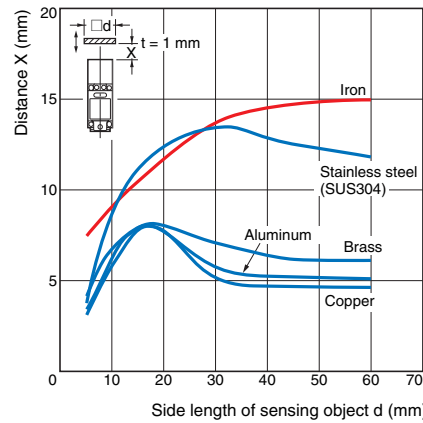

E2Q2-N30M□□-H

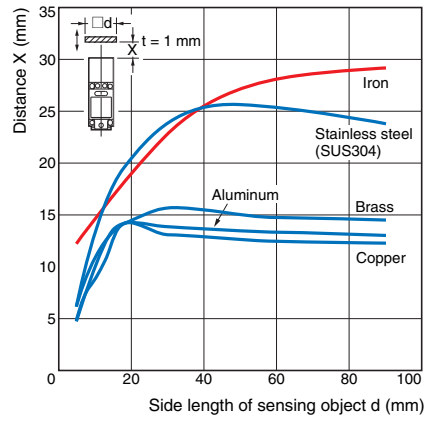

Residual Output Voltage

E2Q2-N□Y4-H

at 24 VAC

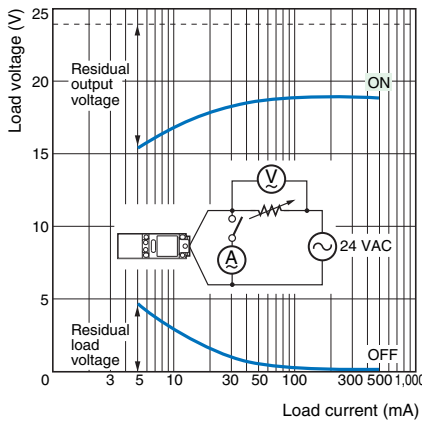

E2Q2-N□Y4-H

at 100 VAC

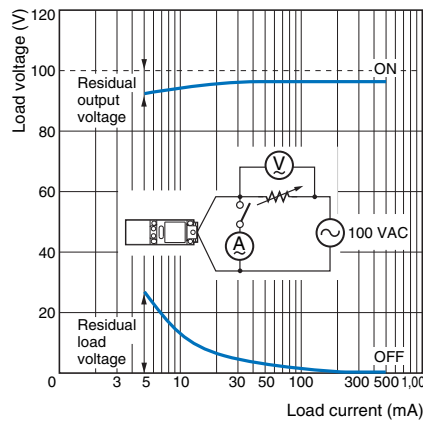

E2Q2-N□Y4-H

at 200 VAC

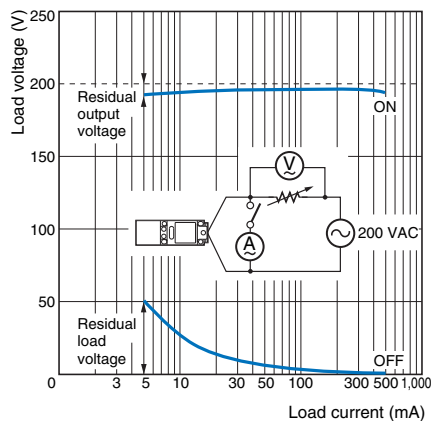

## I/O Circuit Diagrams

### NPN

Operation mode	Models	Timing charts	Output circuits
NO+NC	E2Q2-N20E3-H E2Q2-N30ME3-H	<p><b>NO</b></p> <p>Sensing object Present Not present</p> <p>Detection indicator (yellow) ON OFF</p> <p>Control output ON OFF</p> <p><b>NC</b></p> <p>Sensing object Present Not present</p> <p>Detection indicator (yellow) ON OFF</p> <p>Control output ON OFF</p>	

### PNP

Operation mode	Models	Timing charts	Output circuits
NO+NC	E2Q2-N20F3-H E2Q2-N30MF3-H	<p><b>NO</b></p> <p>Sensing object Present Not present</p> <p>Detection indicator (yellow) ON OFF</p> <p>Control output ON OFF</p> <p><b>NC</b></p> <p>Sensing object Present Not present</p> <p>Detection indicator (yellow) ON OFF</p> <p>Control output ON OFF</p>	

### AC

Operation mode	Models	Timing charts	Output circuits
NO/NC	E2Q2-N15Y4-H E2Q2-N30MY4-H	<p><b>NO</b></p> <p>Sensing object Present Not present</p> <p>Detection indicator (yellow) ON OFF</p> <p>Control output ON OFF</p> <p><b>NC</b></p> <p>Sensing object Present Not present</p> <p>Detection indicator (yellow) ON OFF</p> <p>Control output ON OFF</p>	<p>Note: Connect either NO or NC.</p>

**Safety Precautions**

**WARNING**

This product is not designed or rated for ensuring safety of persons. Do not use it for such purposes.



**Precautions for Safe Use**

**Precautions for Compliance with UL Standards**  
 The product is compliant with UL standards. To meet the requirements for the standards, however, metal connectors or conduits must not be used. When using for UL applications, be sure to use a UL-listed cable clamp.

**Precautions for Correct Use**

Do not use this product under ambient conditions that exceed the ratings.

**Design**

**Power Reset Time**

The Sensor is ready to operate 300 ms after the Sensor is turned ON. If the load and Sensor are connected to independent power supplies respectively, be sure to turn ON the Sensor before supplying power to the load.

**Influence of Surrounding Metal**

When mounting the Sensor within a metal panel, ensure that the clearances given in the following table are maintained.

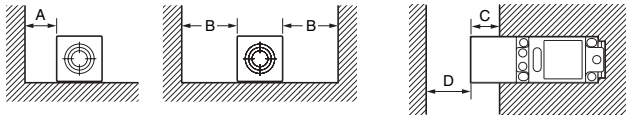

(Unit: mm)

Model	Item	A	B	C	D
E2Q2-N□□□-H		0	10	0	40
E2Q2-N□M□□-H		15	25	25	40

**Mutual Interference**

When installing Sensors face-to-face or side-by-side, ensure that the minimum distances given in the following table are maintained.

**Face-to-face**

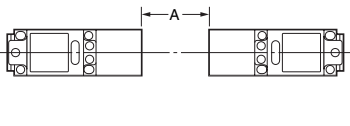

**Parallel**

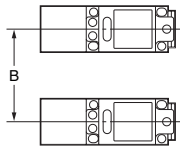

(Unit: mm)

Model	Item	A	B
E2Q2-N□□□-H		170	100
E2Q2-N□M□□-H		280	200

**Mounting**

**Changing the sensing surface direction.**

1. Remove the 2 screws on the back of the Sensor.
2. Removing part A allows the sensing surface position to be changed to the front or sides of the Sensor.

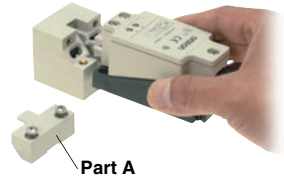

3. When positioning the sensing surface to the side, rotate it to the required position, then fit it into the case. The possible positions are 0, 90, 180, and 270°. Do not forcefully rotate the sensing surface.
4. Secure part A with the screws.

4. Secure part A with the screws.

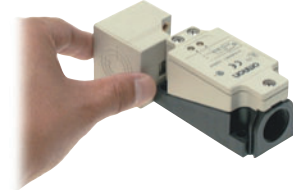

**Operating Environment**

**Ambient Atmosphere**

Do not install the product in the following locations. Doing so may result in product failure or malfunction.

1. Locations subject to corrosive gas.
2. Locations subject to shock or vibration.
3. Locations subject to exposure to water, oil, or chemicals.

Dimensions

Unless otherwise specified, the tolerance class IT16 is used for dimensions in this data sheet.

Sensors

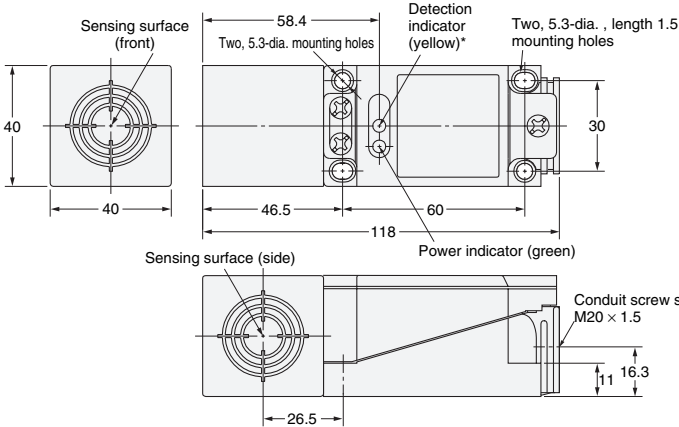

Mounting Hole Dimensions

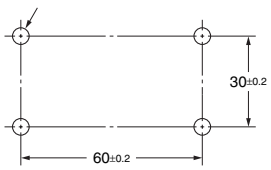

\*AC models have a yellow operation indicator.

In the interest of product improvement, specifications are subject to change without notice.

## Terms and Conditions Agreement

### Read and understand this catalog.

Please read and understand this catalog before purchasing the products. Please consult your OMRON representative if you have any questions or comments.

### Warranties.

(a) Exclusive Warranty. Omron's exclusive warranty is that the Products will be free from defects in materials and workmanship for a period of twelve months from the date of sale by Omron (or such other period expressed in writing by Omron). Omron disclaims all other warranties, express or implied.

(b) Limitations. OMRON MAKES NO WARRANTY OR REPRESENTATION, EXPRESS OR IMPLIED, ABOUT NON-INFRINGEMENT, MERCHANTABILITY OR FITNESS FOR A PARTICULAR PURPOSE OF THE PRODUCTS. BUYER ACKNOWLEDGES THAT IT ALONE HAS DETERMINED THAT THE PRODUCTS WILL SUITABLY MEET THE REQUIREMENTS OF THEIR INTENDED USE.

Omron further disclaims all warranties and responsibility of any type for claims or expenses based on infringement by the Products or otherwise of any intellectual property right. (c) Buyer Remedy. Omron's sole obligation hereunder shall be, at Omron's election, to (i) replace (in the form originally shipped with Buyer responsible for labor charges for removal or replacement thereof) the non-complying Product, (ii) repair the non-complying Product, or (iii) repay or credit Buyer an amount equal to the purchase price of the non-complying Product; provided that in no event shall Omron be responsible for warranty, repair, indemnity or any other claims or expenses regarding the Products unless Omron's analysis confirms that the Products were properly handled, stored, installed and maintained and not subject to contamination, abuse, misuse or inappropriate modification. Return of any Products by Buyer must be approved in writing by Omron before shipment. Omron Companies shall not be liable for the suitability or unsuitability or the results from the use of Products in combination with any electrical or electronic components, circuits, system assemblies or any other materials or substances or environments. Any advice, recommendations or information given orally or in writing, are not to be construed as an amendment or addition to the above warranty.

See <http://www.omron.com/global/> or contact your Omron representative for published information.

### Limitation on Liability; Etc.

OMRON COMPANIES SHALL NOT BE LIABLE FOR SPECIAL, INDIRECT, INCIDENTAL, OR CONSEQUENTIAL DAMAGES, LOSS OF PROFITS OR PRODUCTION OR COMMERCIAL LOSS IN ANY WAY CONNECTED WITH THE PRODUCTS, WHETHER SUCH CLAIM IS BASED IN CONTRACT, WARRANTY, NEGLIGENCE OR STRICT LIABILITY.

Further, in no event shall liability of Omron Companies exceed the individual price of the Product on which liability is asserted.

### Suitability of Use.

Omron Companies shall not be responsible for conformity with any standards, codes or regulations which apply to the combination of the Product in the Buyer's application or use of the Product. At Buyer's request, Omron will provide applicable third party certification documents identifying ratings and limitations of use which apply to the Product. This information by itself is not sufficient for a complete determination of the suitability of the Product in combination with the end product, machine, system, or other application or use. Buyer shall be solely responsible for determining appropriateness of the particular Product with respect to Buyer's application, product or system. Buyer shall take application responsibility in all cases.

NEVER USE THE PRODUCT FOR AN APPLICATION INVOLVING SERIOUS RISK TO LIFE OR PROPERTY OR IN LARGE QUANTITIES WITHOUT ENSURING THAT THE SYSTEM AS A WHOLE HAS BEEN DESIGNED TO ADDRESS THE RISKS, AND THAT THE OMRON PRODUCT(S) IS PROPERLY RATED AND INSTALLED FOR THE INTENDED USE WITHIN THE OVERALL EQUIPMENT OR SYSTEM.

### Programmable Products.

Omron Companies shall not be responsible for the user's programming of a programmable Product, or any consequence thereof.

### Performance Data.

Data presented in Omron Company websites, catalogs and other materials is provided as a guide for the user in determining suitability and does not constitute a warranty. It may represent the result of Omron's test conditions, and the user must correlate it to actual application requirements. Actual performance is subject to the Omron's Warranty and Limitations of Liability.

### Change in Specifications.

Product specifications and accessories may be changed at any time based on improvements and other reasons. It is our practice to change part numbers when published ratings or features are changed, or when significant construction changes are made. However, some specifications of the Product may be changed without any notice. When in doubt, special part numbers may be assigned to fix or establish key specifications for your application. Please consult with your Omron's representative at any time to confirm actual specifications of purchased Product.

### Errors and Omissions.

Information presented by Omron Companies has been checked and is believed to be accurate; however, no responsibility is assumed for clerical, typographical or proofreading errors or omissions.