

4

3

2

1

THIS DRAWING IS UNPUBLISHED. RELEASED FOR PUBLICATION 20
 © COPYRIGHT 20 BY TYCO ELECTRONICS CORPORATION. ALL RIGHTS RESERVED.

LOC	DIST	REVISIONS			
P	LTR	DESCRIPTION	DATE	DWN	APVD
F	00	B	ECR 07-025006	23OCT2007	JT GR

COUPE C-C

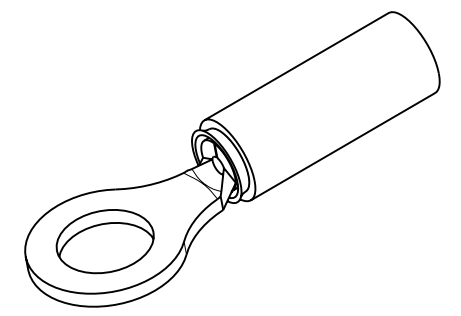
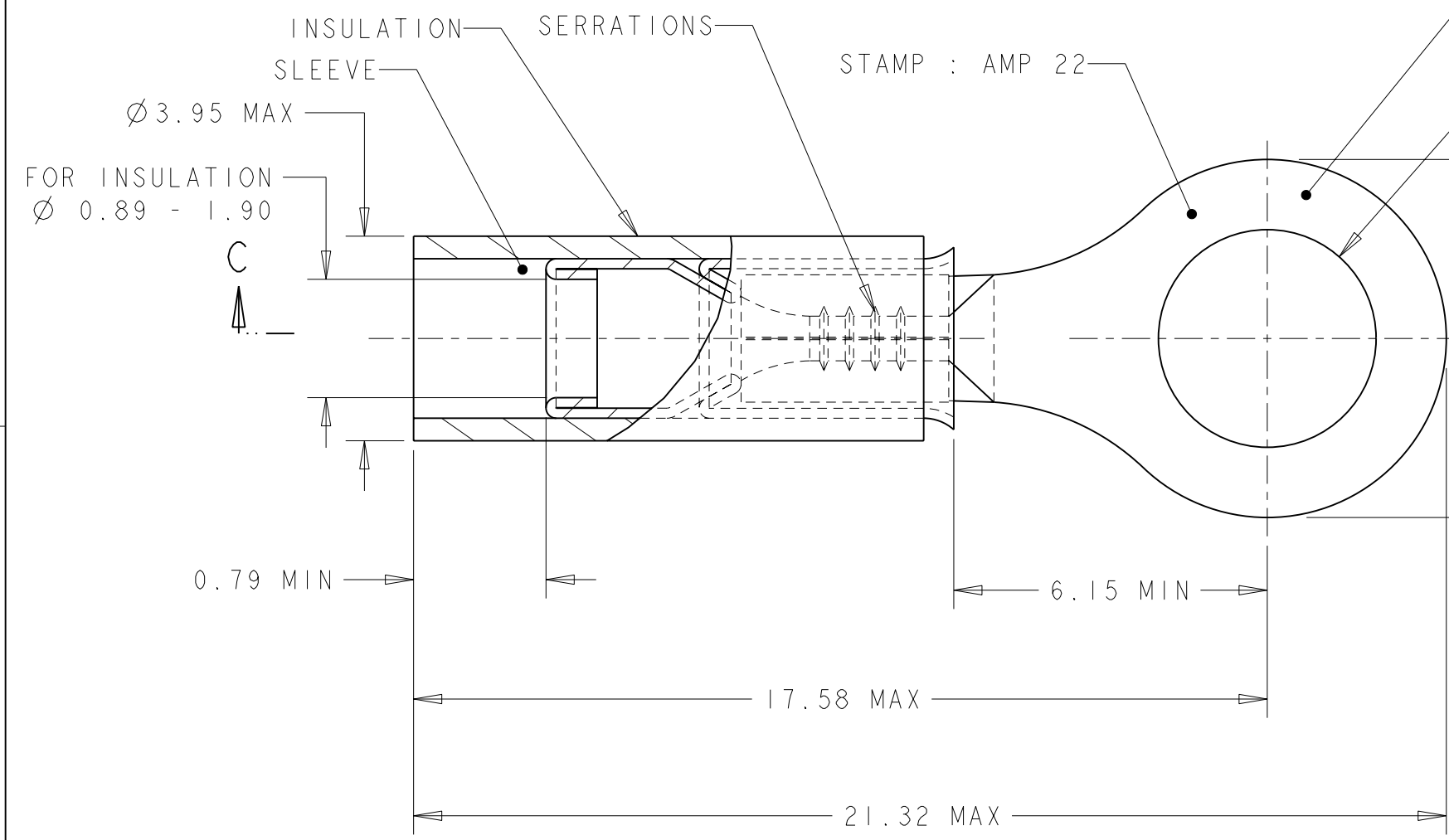
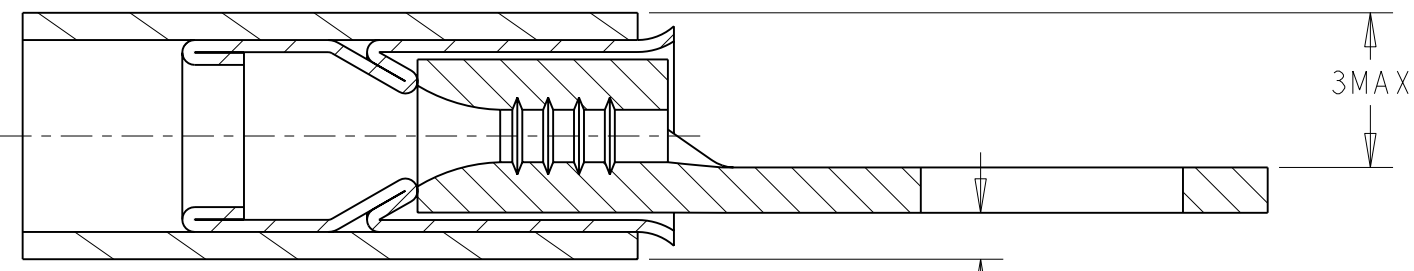

SCALE 3:1

WIRE TERMINAL	1577620-1	BODY : COPPER ANNEALED FINISH : NICKEL PLATED
		SLEEVE : COPPER ANNEALED FINISH : NICKEL PLATED
		INSULATION : PEEK COLOR : BROWN
DESCRIPTION	PART NUMBER	MATERIAL & FINISH

<small>THIS DRAWING IS A CONTROLLED DOCUMENT FOR TYCO ELECTRONICS CORPORATION IT IS SUBJECT TO CHANGE AND THE CONTROLLING ENGINEERING ORGANIZATION SHOULD BE CONTACTED FOR THE LATEST REVISION.</small>		DWN	18OCT2005		TYCO ELECTRONICS France SAS	
DIMENSIONS: mm		CHK	18OCT2005		BP 30039, 95301 CERGY-PONTOISE Cedex	
TOLERANCES UNLESS OTHERWISE SPECIFIED:		APVD	18OCT2005		NAME	
0 PLC ±- 1 PLC ±0.30 2 PLC ±- 3 PLC ±- 4 PLC ±- ANGLES ±5 FINISH SEE TABLE		PRODUCT SPEC	108-15356		TERMINAL, PEEK PIDG STRATO, 24-22 AWG	
MATERIAL	SEE TABLE	APPLICATION SPEC	114-15102	SIZE	CAGE CODE	DRAWING NO
		WEIGHT	0,65 gr	A3	00779	©=1577620
		CUSTOMER DRAWING		SCALE	8:1	SHEET 1 OF 1
				RESTRICTED TO		REV B