



# IMPORTANT NOTICE

10 December 2015

## 1. Global joint venture starts operations as WeEn Semiconductors

Dear customer,

As from November 9th, 2015 NXP Semiconductors N.V. and Beijing JianGuang Asset Management Co. Ltd established Bipolar Power joint venture (JV), **WeEn Semiconductors**, which will be used in future Bipolar Power documents together with new contact details.

In this document where the previous NXP references remain, please use the new links as shown below.

**WWW** - For [www.nxp.com](http://www.nxp.com) use [www.ween-semi.com](http://www.ween-semi.com)

**Email** - For [salesaddresses@nxp.com](mailto:salesaddresses@nxp.com) use [salesaddresses@ween-semi.com](mailto:salesaddresses@ween-semi.com)

For the copyright notice at the bottom of each page (or elsewhere in the document, depending on the version) “© **NXP Semiconductors N.V. {year}. All rights reserved**” becomes “© **WeEn Semiconductors Co., Ltd. {year}. All rights reserved**”

If you have any questions related to this document, please contact our nearest sales office via e-mail or phone (details via [salesaddresses@ween-semi.com](mailto:salesaddresses@ween-semi.com)).

Thank you for your cooperation and understanding,

WeEn Semiconductors



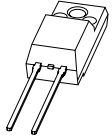

# BYC15X-600

Rectifier diode, hyperfast

Rev. 01 — 29 November 2007

Product data sheet

## 1. Product profile

### 1.1 General description

Hyperfast, epitaxial rectifier diode in a SOD113 (2-lead TO-220F) plastic package.

### 1.2 Features

- Extremely fast switching
- Low reverse recovery current
- Reduces switching loss in associated MOSFET
- Low thermal resistance
- Isolated package

### 1.3 Applications

- Half-bridge or full-bridge switched-mode power supplies
- Half-bridge lighting ballasts
- Continuous Current Mode (CCM) Power Factor Correction (PFC)

### 1.4 Quick reference data

- $V_{RRM} \leq 600$  V
- $V_F = 1.32$  V (typ)
- $I_{F(AV)} \leq 15$  A
- $t_{rr} = 19$  ns (typ)

## 2. Pinning information

Table 1. Pinning

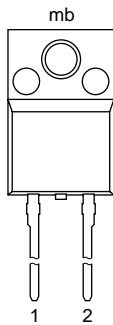
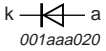
Pin	Description	Simplified outline	Symbol
1	cathode (k)		
2	anode (a)		
mb	mounting base; isolated		

SOD113 (2-lead TO-220F)

### 3. Ordering information

**Table 2. Ordering information**

Type number	Package		Version
	Name	Description	
BYC15X-600	TO-220F	plastic single-ended package; isolated heatsink mounted; 1 mounting hole; 2-lead TO-220 'full pack'	SOD113

### 4. Limiting values

**Table 3. Limiting values**

*In accordance with the Absolute Maximum Rating System (IEC 60134).*

Symbol	Parameter	Conditions	Min	Max	Unit
$V_{RRM}$	repetitive peak reverse voltage		-	600	V
$V_{RWM}$	crest working reverse voltage		-	600	V
$V_R$	reverse voltage	square waveform; $\delta = 1.0$ ; $T_h \leq 100$ °C	-	500	V
$I_{F(AV)}$	average forward current	square waveform; $\delta = 0.5$ ; $T_h \leq 25$ °C	-	15	A
$I_{FRM}$	repetitive peak forward current	square waveform; $\delta = 0.5$ ; $T_h \leq 25$ °C; $t_p = 25$ $\mu$ s	-	30	A
$I_{FSM}$	non-repetitive peak forward current	$t = 10$ ms; sinusoidal waveform	-	200	A
		$t = 8.3$ ms; sinusoidal waveform	-	220	A
$T_{stg}$	storage temperature		-40	+150	°C
$T_j$	junction temperature		-	150	°C

### 5. Thermal characteristics

Table 4. Thermal characteristics

Symbol	Parameter	Conditions	Min	Typ	Max	Unit
$R_{th(j-h)}$	thermal resistance from junction to heatsink	with heatsink compound; see <a href="#">Figure 1</a>	-	-	3.6	K/W
$R_{th(j-a)}$	thermal resistance from junction to ambient	in free air	-	55	-	K/W

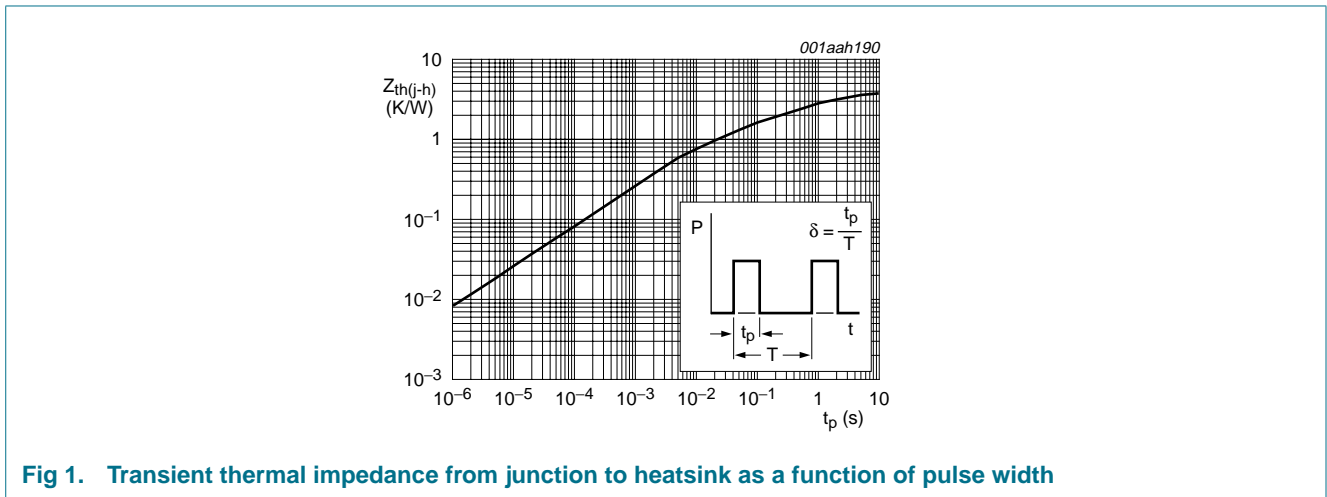

### 6. Isolation characteristics

Table 5. Isolation limiting values and characteristics

$T_h = 25\text{ }^\circ\text{C}$  unless otherwise specified.

Symbol	Parameter	Conditions	Min	Typ	Max	Unit
$V_{isol(RMS)}$	RMS isolation voltage	from all terminals to external heatsink; $f = 50\text{ Hz to }60\text{ Hz}$ ; sinusoidal waveform; relative humidity $\leq 65\%$ ; clean and dust free	-	-	2500	V
$C_{isol}$	isolation capacitance	from pin 1 (cathode) to external heatsink; $f = 1\text{ MHz}$	-	10	-	pF

## 7. Characteristics

**Table 6. Characteristics**

$T_j = 25\text{ °C}$  unless otherwise specified.

Symbol	Parameter	Conditions	Min	Typ	Max	Unit
<b>Static characteristics</b>						
$V_F$	forward voltage	$I_F = 15\text{ A}$ ; $T_j = 150\text{ °C}$ ; see <a href="#">Figure 2</a>	-	1.32	2.03	V
		$I_F = 30\text{ A}$ ; $T_j = 150\text{ °C}$ ; see <a href="#">Figure 2</a>	-	1.64	2.34	V
		$I_F = 15\text{ A}$ ; see <a href="#">Figure 2</a>	-	1.89	2.9	V
$I_R$	reverse current	$V_R = 600\text{ V}$	-	12	200	$\mu\text{A}$
		$V_R = 500\text{ V}$ ; $T_j = 100\text{ °C}$	-	1.1	3.0	mA
<b>Dynamic characteristics</b>						
$t_{rr}$	reverse recovery time	$I_F = 1\text{ A}$ to $V_R = 30\text{ V}$ ; $dI_F/dt = 50\text{ A}/\mu\text{s}$ ; see <a href="#">Figure 3</a>	-	35	55	ns
		$I_F = 15\text{ A}$ to $V_R = 400\text{ V}$ ; $dI_F/dt = 500\text{ A}/\mu\text{s}$ ; see <a href="#">Figure 3</a>	-			
		$T_j = 25\text{ °C}$	-	19	-	ns
		$T_j = 100\text{ °C}$	-	32	40	ns
$I_{RM}$	peak reverse recovery current	$I_F = 15\text{ A}$ to $V_R = 400\text{ V}$ ; $T_j = 125\text{ °C}$ ; see <a href="#">Figure 3</a>	-			
		$dI_F/dt = 50\text{ A}/\mu\text{s}$	-	3.0	7.5	A
		$dI_F/dt = 500\text{ A}/\mu\text{s}$	-	9.5	12	A
$V_{FR}$	forward recovery voltage	$I_F = 15\text{ A}$ ; $dI_F/dt = 100\text{ A}/\mu\text{s}$ ; see <a href="#">Figure 4</a>	-	8	11	V

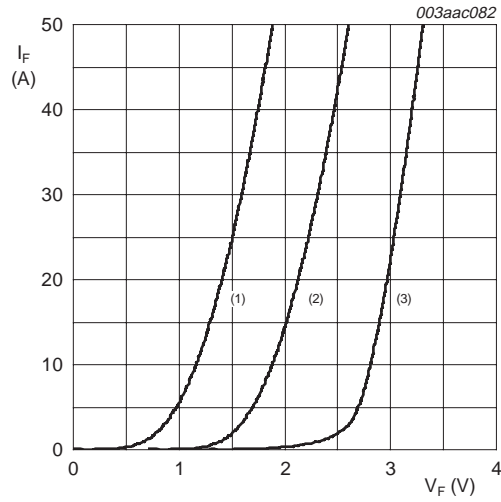

- (1)  $T_j = 150\text{ °C}$ ; typical values
- (2)  $T_j = 150\text{ °C}$ ; maximum values
- (3)  $T_j = 25\text{ °C}$ ; maximum values

Fig 2. Forward current as a function of forward voltage

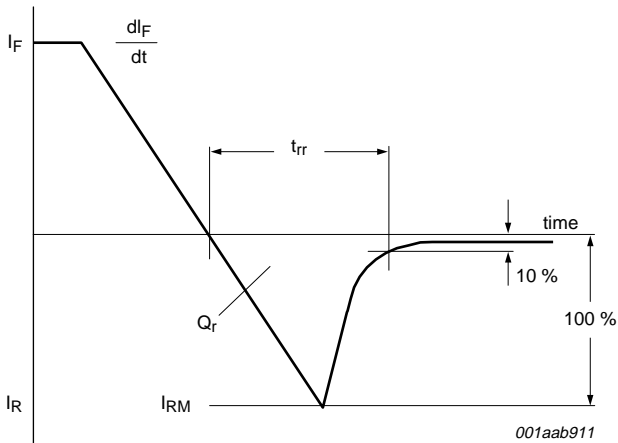

Fig 3. Reverse recovery definitions

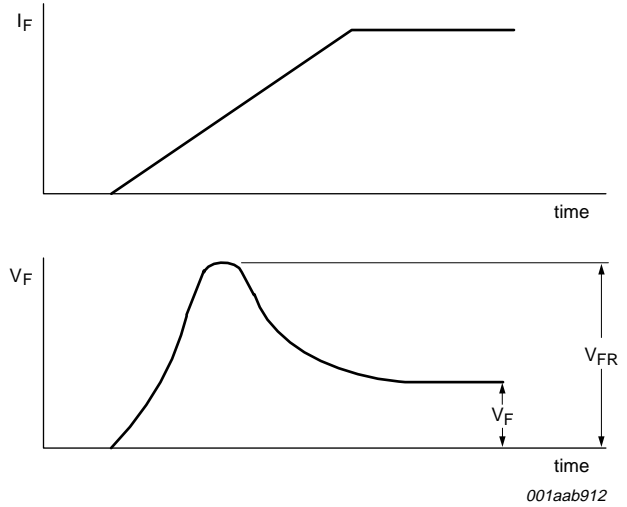
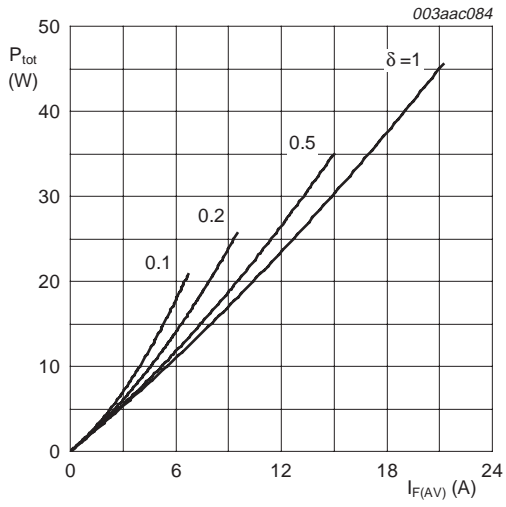
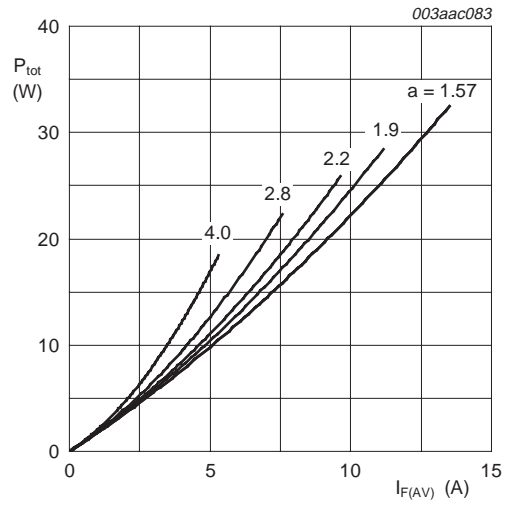

Fig 4. Forward recovery definitions



$$I_{F(AV)} = I_{F(RMS)} \times \sqrt{\delta}$$

**Fig 5. Forward power dissipation as a function of average forward current; square waveform; maximum values**



$$a = \text{form factor} = I_{F(RMS)} / I_{F(AV)}$$

**Fig 6. Forward power dissipation as a function of average forward current; sinusoidal waveform; maximum values**

8. Package outline

Plastic single-ended package; isolated heatsink mounted;  
1 mounting hole; 2-lead TO-220 'full pack'

SOD113

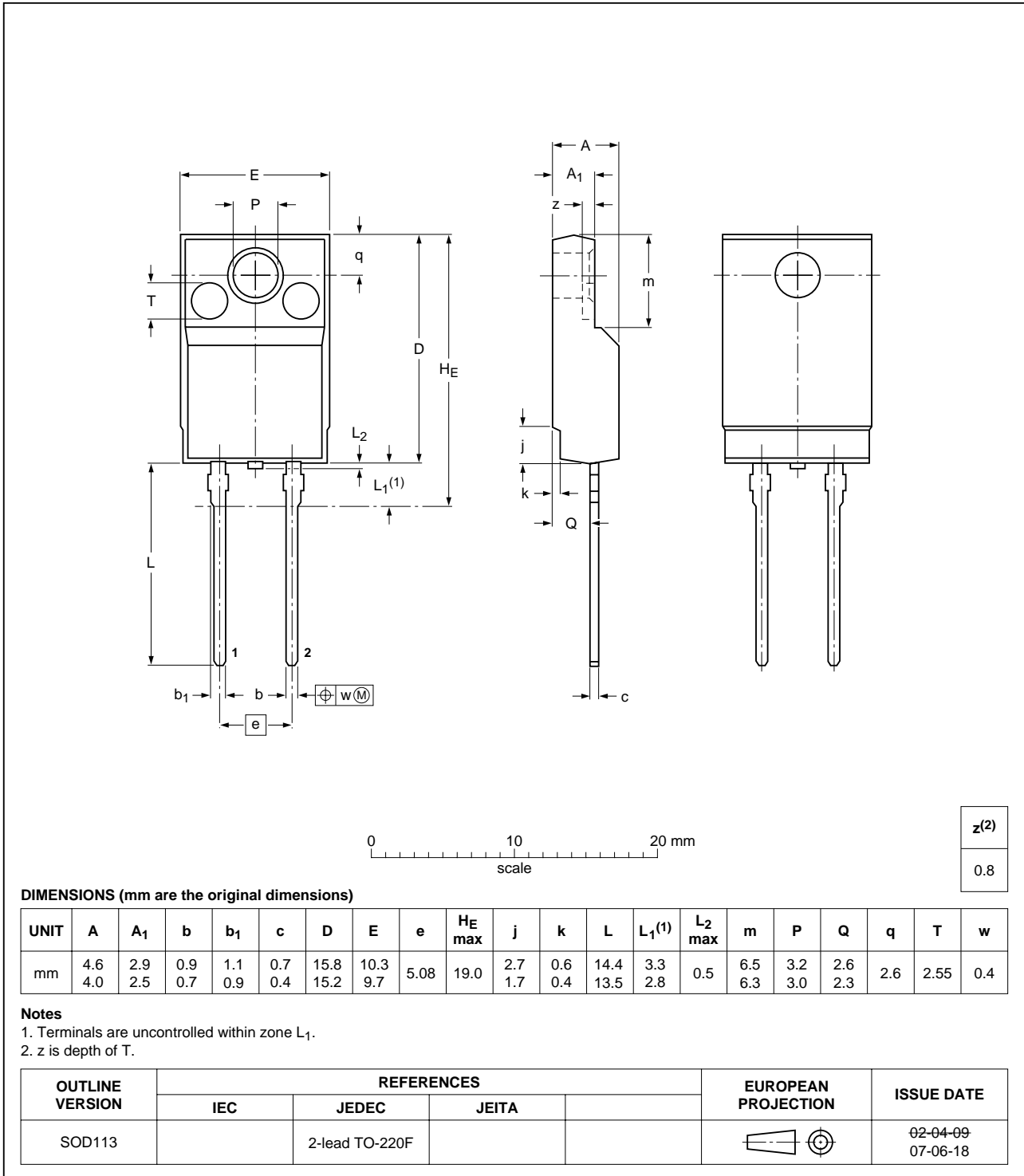

Fig 7. Package outline SOD113 (2-lead TO-220F)



## 9. Revision history

**Table 7.** Revision history

Document ID	Release date	Data sheet status	Change notice	Supersedes
BYC15X-600_1	20071129	Product data sheet	-	-

## 10. Legal information

### 10.1 Data sheet status

Document status <sup>[1][2]</sup>	Product status <sup>[3]</sup>	Definition
Objective [short] data sheet	Development	This document contains data from the objective specification for product development.
Preliminary [short] data sheet	Qualification	This document contains data from the preliminary specification.
Product [short] data sheet	Production	This document contains the product specification.

[1] Please consult the most recently issued document before initiating or completing a design.

[2] The term 'short data sheet' is explained in section "Definitions".

[3] The product status of device(s) described in this document may have changed since this document was published and may differ in case of multiple devices. The latest product status information is available on the Internet at URL <http://www.nxp.com>.

### 10.2 Definitions

**Draft** — The document is a draft version only. The content is still under internal review and subject to formal approval, which may result in modifications or additions. NXP Semiconductors does not give any representations or warranties as to the accuracy or completeness of information included herein and shall have no liability for the consequences of use of such information.

**Short data sheet** — A short data sheet is an extract from a full data sheet with the same product type number(s) and title. A short data sheet is intended for quick reference only and should not be relied upon to contain detailed and full information. For detailed and full information see the relevant full data sheet, which is available on request via the local NXP Semiconductors sales office. In case of any inconsistency or conflict with the short data sheet, the full data sheet shall prevail.

### 10.3 Disclaimers

**General** — Information in this document is believed to be accurate and reliable. However, NXP Semiconductors does not give any representations or warranties, expressed or implied, as to the accuracy or completeness of such information and shall have no liability for the consequences of use of such information.

**Right to make changes** — NXP Semiconductors reserves the right to make changes to information published in this document, including without limitation specifications and product descriptions, at any time and without notice. This document supersedes and replaces all information supplied prior to the publication hereof.

**Suitability for use** — NXP Semiconductors products are not designed, authorized or warranted to be suitable for use in medical, military, aircraft, space or life support equipment, nor in applications where failure or

malfunction of an NXP Semiconductors product can reasonably be expected to result in personal injury, death or severe property or environmental damage. NXP Semiconductors accepts no liability for inclusion and/or use of NXP Semiconductors products in such equipment or applications and therefore such inclusion and/or use is at the customer's own risk.

**Applications** — Applications that are described herein for any of these products are for illustrative purposes only. NXP Semiconductors makes no representation or warranty that such applications will be suitable for the specified use without further testing or modification.

**Limiting values** — Stress above one or more limiting values (as defined in the Absolute Maximum Ratings System of IEC 60134) may cause permanent damage to the device. Limiting values are stress ratings only and operation of the device at these or any other conditions above those given in the Characteristics sections of this document is not implied. Exposure to limiting values for extended periods may affect device reliability.

**Terms and conditions of sale** — NXP Semiconductors products are sold subject to the general terms and conditions of commercial sale, as published at <http://www.nxp.com/profile/terms>, including those pertaining to warranty, intellectual property rights infringement and limitation of liability, unless explicitly otherwise agreed to in writing by NXP Semiconductors. In case of any inconsistency or conflict between information in this document and such terms and conditions, the latter will prevail.

**No offer to sell or license** — Nothing in this document may be interpreted or construed as an offer to sell products that is open for acceptance or the grant, conveyance or implication of any license under any copyrights, patents or other industrial or intellectual property rights.

### 10.4 Trademarks

Notice: All referenced brands, product names, service names and trademarks are the property of their respective owners.

## 11. Contact information

For additional information, please visit: <http://www.nxp.com>

For sales office addresses, send an email to: [salesaddresses@nxp.com](mailto:salesaddresses@nxp.com)

**12. Contents**

**1 Product profile . . . . . 1**

1.1 General description . . . . . 1

1.2 Features . . . . . 1

1.3 Applications . . . . . 1

1.4 Quick reference data . . . . . 1

**2 Pinning information . . . . . 1**

**3 Ordering information . . . . . 2**

**4 Limiting values . . . . . 2**

**5 Thermal characteristics . . . . . 3**

**6 Isolation characteristics . . . . . 3**

**7 Characteristics . . . . . 4**

**8 Package outline . . . . . 7**

**9 Revision history . . . . . 8**

**10 Legal information . . . . . 9**

10.1 Data sheet status . . . . . 9

10.2 Definitions . . . . . 9

10.3 Disclaimers . . . . . 9

10.4 Trademarks . . . . . 9

**11 Contact information . . . . . 9**

**12 Contents . . . . . 10**

Please be aware that important notices concerning this document and the product(s) described herein, have been included in section 'Legal information'.



© NXP B.V. 2007.

All rights reserved.

For more information, please visit: <http://www.nxp.com>

For sales office addresses, please send an email to: [salesaddresses@nxp.com](mailto:salesaddresses@nxp.com)

Date of release: 29 November 2007

Document identifier: BYC15X-600\_1