

Fast Switching SCR T72_45

450A Avg.
(700 RMS)
Up to 1200 Volts
15-60 μ s

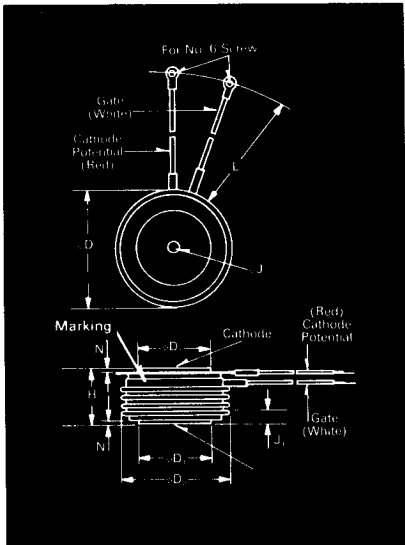

Symbol	Inches		Millimeters	
	Min.	Max.	Min.	Max.
ϕD	2.250	2.290	57.15	58.17
ϕD_1	1.333	1.343	33.86	34.11
ϕD_2	2.030	2.090	51.56	53.09
H	1.020	1.060	25.91	26.92
ϕJ	.135	.145	3.43	3.68
J_1	.075	.090	1.91	2.29
L	7.75	8.50	196.85	215.90
N	.040		1.02	

Creep Distance—1.00 in. min. (25.40 mm).
Strike Distance—.69 in. min. (17.53 mm).
(In accordance with NEMA standards.)
Finish—Nickel Plate.

Approx. Weight—8 oz. (227 g).
1. Dimension "H" is a clamped dimension.

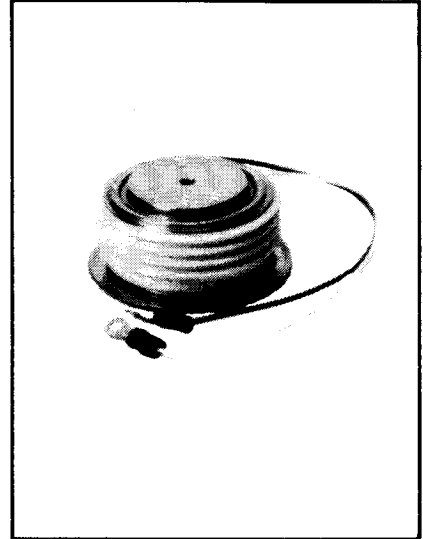

T72 Outline

Features:

- Center fired di/dynamic gate
- High di/dt with soft gate control
- High frequency operation
- Sinusoidal waveform operation to 20KHz
- Rectangular waveform operation to 20KHz
- Low dynamic forward voltage drop
- Low switching losses at high frequency
- Lifetime Guarantee

Applications:

- Inverters
- UPS
- Induction heating
- AC motor drives
- Cycloconverters
- Choppers
- Crowbars

Ordering Information

Type	Voltage		Current		Turn-off		Gate Current		Leads	
Code	V_{DRM} and V_{RRM} (V)	Code	$I_{T(av)}$ (A)	Code	tq μ sec	Code	I_{GT} (ma)	Code	Case	Code
T727	100	01	450	45	15	7	150	4	T72	DN
	200	02			20	6				
	300	03			25	8				
	400	04			30	5				
	500	05			40	4				
	600	06			50	3				
	700	07			60	2				
	800	08								
	900	09								
	1000	10								
	1100	11								
	1200	12								
	1400	*14								

Example

Obtain optimum device performance for your application by selecting proper Order Code.

Type T727 rated at 450 A average with $V_{DRM} = 1000V$,
 $I_{GT} = 150$ ma, tq = 30 μ sec max. and standard control leads—order as:

Type	Voltage	Current	Turn Off	Gate Current	Leads
T 7 2 7	1 0	4 5	5	4	D N

*for 15 and 20 μ sec V F data,
consult factory

450A Avg.
(700 RMS)
Up to 1200 Volts
15-60 μ s

Fast Switching
SCR
T727_45

Voltage

Blocking State Maximums [ⓐ] ($T_J = 125^\circ\text{C}$)

Symbol	Value
V_{DRM}	100
V_{RRM}	100
V_{RSM}	200
I_{DRM}	30
I_{RRM}	30

100	200	300	400	500	600	700	800	900	1000	1100	1200	1400
100	200	300	400	500	600	700	800	900	1000	1100	1200	1400
200	300	400	500	600	700	800	900	1000	1100	1200	1300	1500

Current

Conducting State Maximums
($T_J = 125^\circ\text{C}$)

Symbol	T727--45
$I_{T(rms)}$	700
$I_{T(av)}$	450
I_{TSM}	8000
I^2t	265,000
V_{TM}	1.45
di/dt	400

Switching

($T_J = 25^\circ\text{C}$)

Symbol	Value
t_q	15 to 60
t_{on}	3.0
dv/dt	300
di/dt	800

Gate

Maximum Parameters
($T_J = 25^\circ\text{C}$)

Symbol	Value
I_{GT}	150
V_{GT}	3
V_{GDM}	0.15
I_{GTM}	4
V_{GRM}	5
P_{GM}	16
$P_{G(av)}$	3

Thermal and Mechanical

Symbol	Value
T_J	-40 to +125
T_{stg}	-40 to +150
	2000 to 2400
$R_{\theta JC}$.06
$R_{\theta CS}$.02

- ⓐ Consult recommended mounting procedures.
- ⓑ Applies for zero or negative gate bias.
- ⓒ Per JEDEC RS-397, 5.2.2.1.
- ⓓ With recommended gate drive.
- ⓔ Higher dv/dt ratings available, consult factory.
- ⓕ Per JEDEC standard RS-397, 5.2.2.6.
- ⓖ For operation with antiparallel diode, consult factory.

Maximum Forward Voltage Drop VS Forward Current

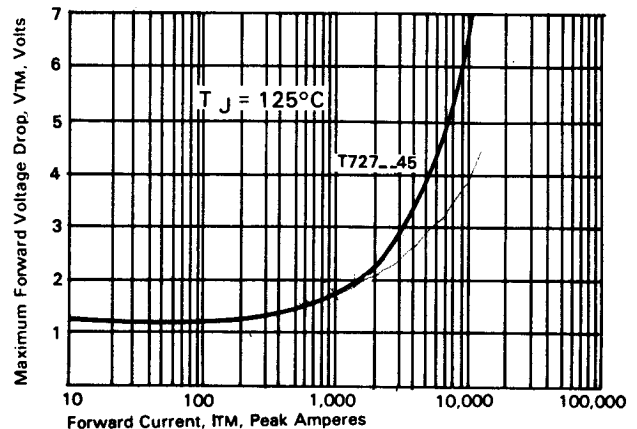

Transient Thermal Impedance VS. Time

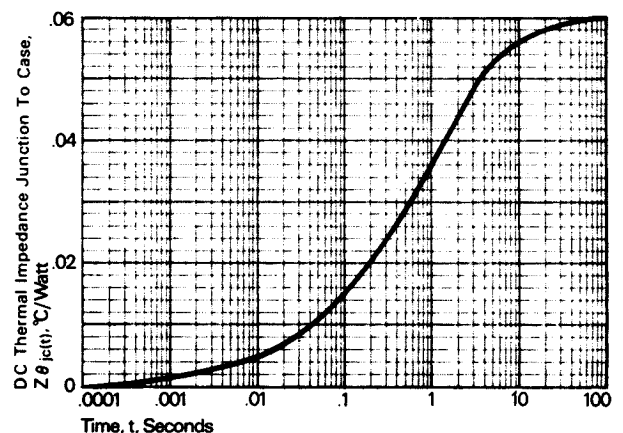

FAST SWITCHING THYRISTORS

Fast Switching SCR T727_45

450A Avg.
(700 RMS)
Up to 1200 Volts
15-60 μ s

Sinusoidal Current Data

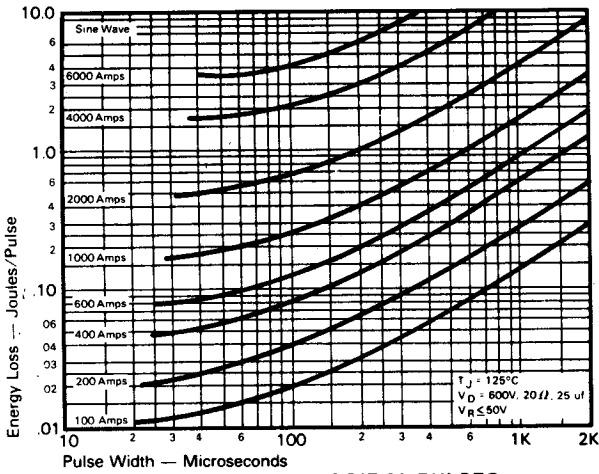

Trapezoidal Wave Current Data

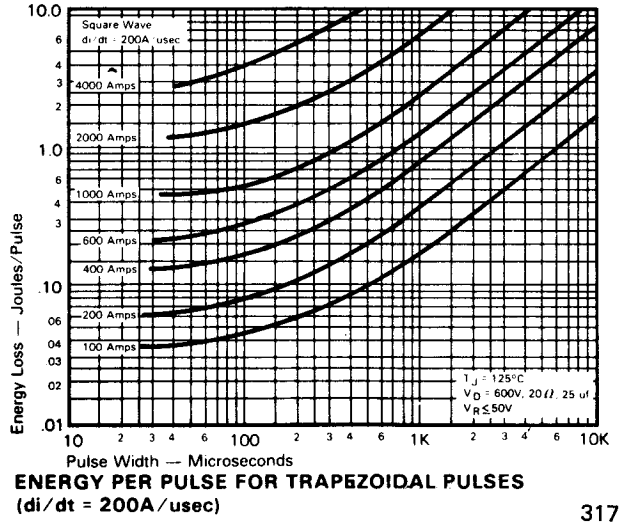
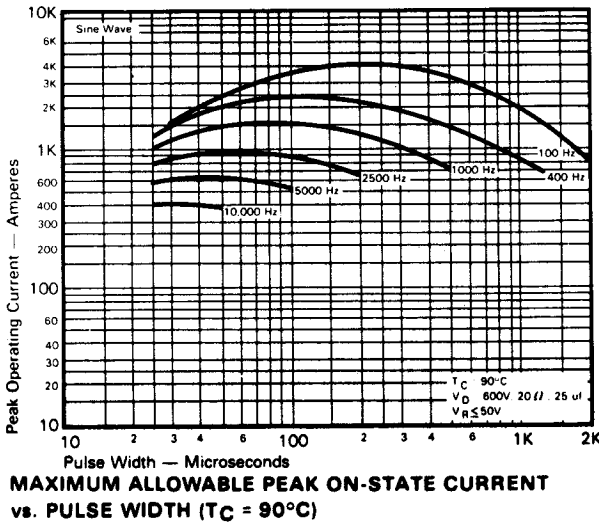
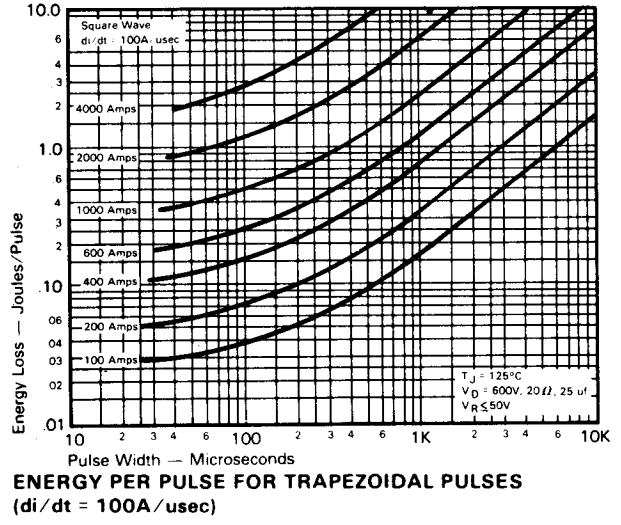
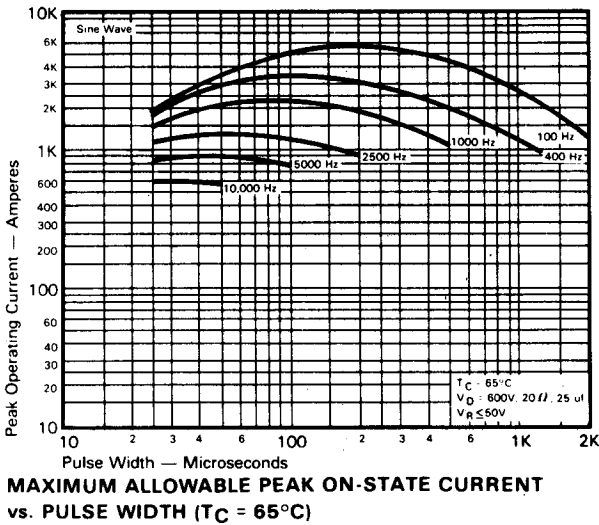
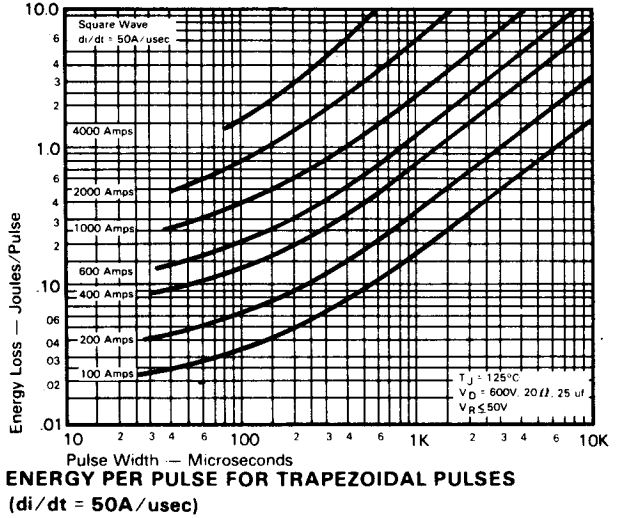

FAST SWITCHING
THYRISTORS

450A Avg.
(700 RMS)
Up to 1200 Volts
15-60 μ s

Fast Switching
SCR
T727_45

Trapezoidal Wave Current Data
($T_C = 65^\circ\text{C}$)

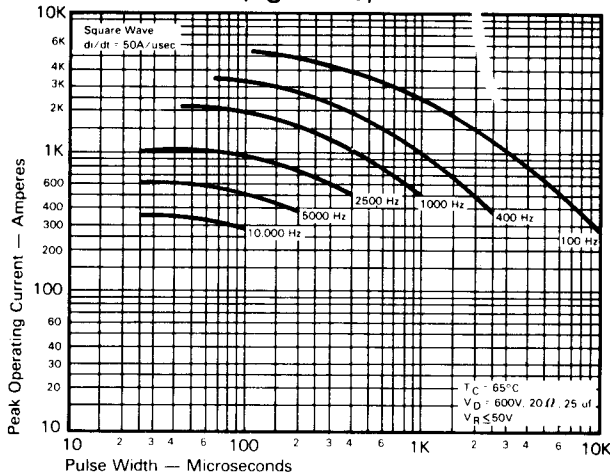

MAXIMUM ALLOWABLE PEAK ON-STATE CURRENT vs. PULSE WIDTH ($di/dt = 50\text{A}/\mu\text{sec}$)

Trapezoidal Wave Current Data
($T_C = 90^\circ\text{C}$)

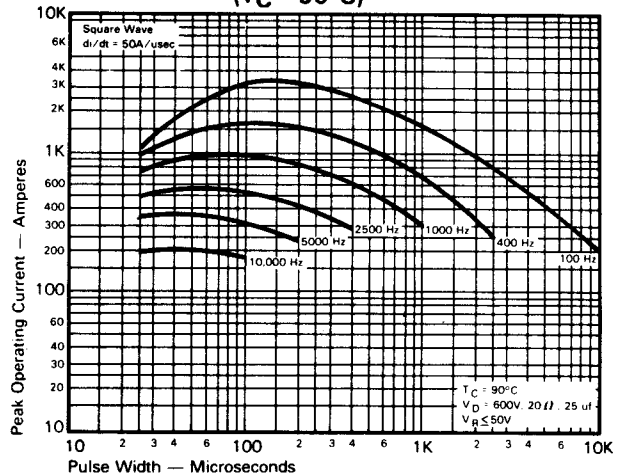

MAXIMUM ALLOWABLE PEAK ON-STATE CURRENT vs. PULSE WIDTH ($di/dt = 50\text{A}/\mu\text{sec}$)

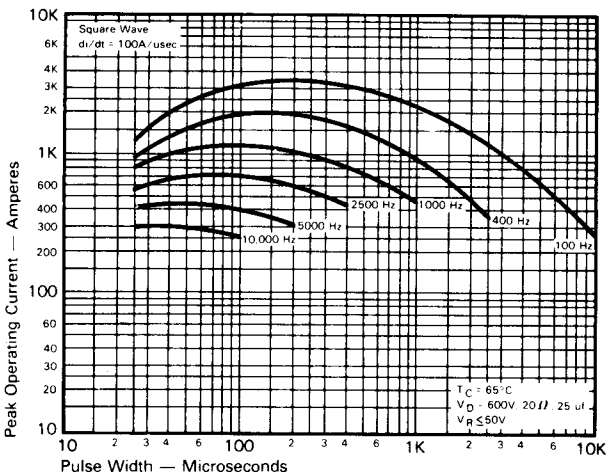

MAXIMUM ALLOWABLE PEAK ON-STATE CURRENT vs. PULSE WIDTH ($di/dt = 100\text{A}/\mu\text{sec}$)

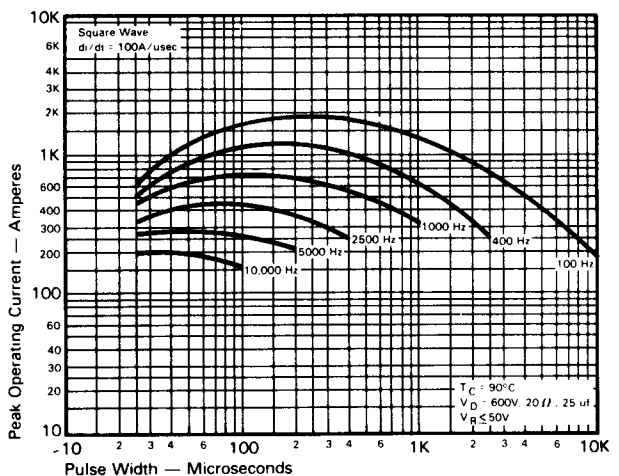

MAXIMUM ALLOWABLE PEAK ON-STATE CURRENT vs. PULSE WIDTH ($di/dt = 100\text{A}/\mu\text{sec}$)

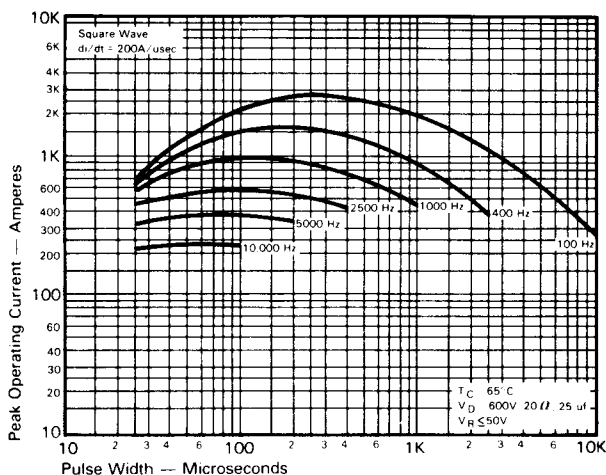

MAXIMUM ALLOWABLE PEAK ON-STATE CURRENT vs. PULSE WIDTH ($di/dt = 200\text{A}/\mu\text{sec}$)

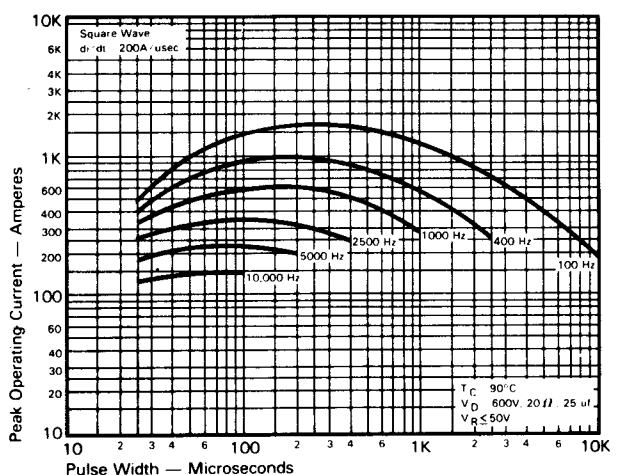

MAXIMUM ALLOWABLE PEAK ON-STATE CURRENT vs. PULSE WIDTH ($di/dt = 200\text{A}/\mu\text{sec}$)

FAST SWITCHING
THYRISTORS

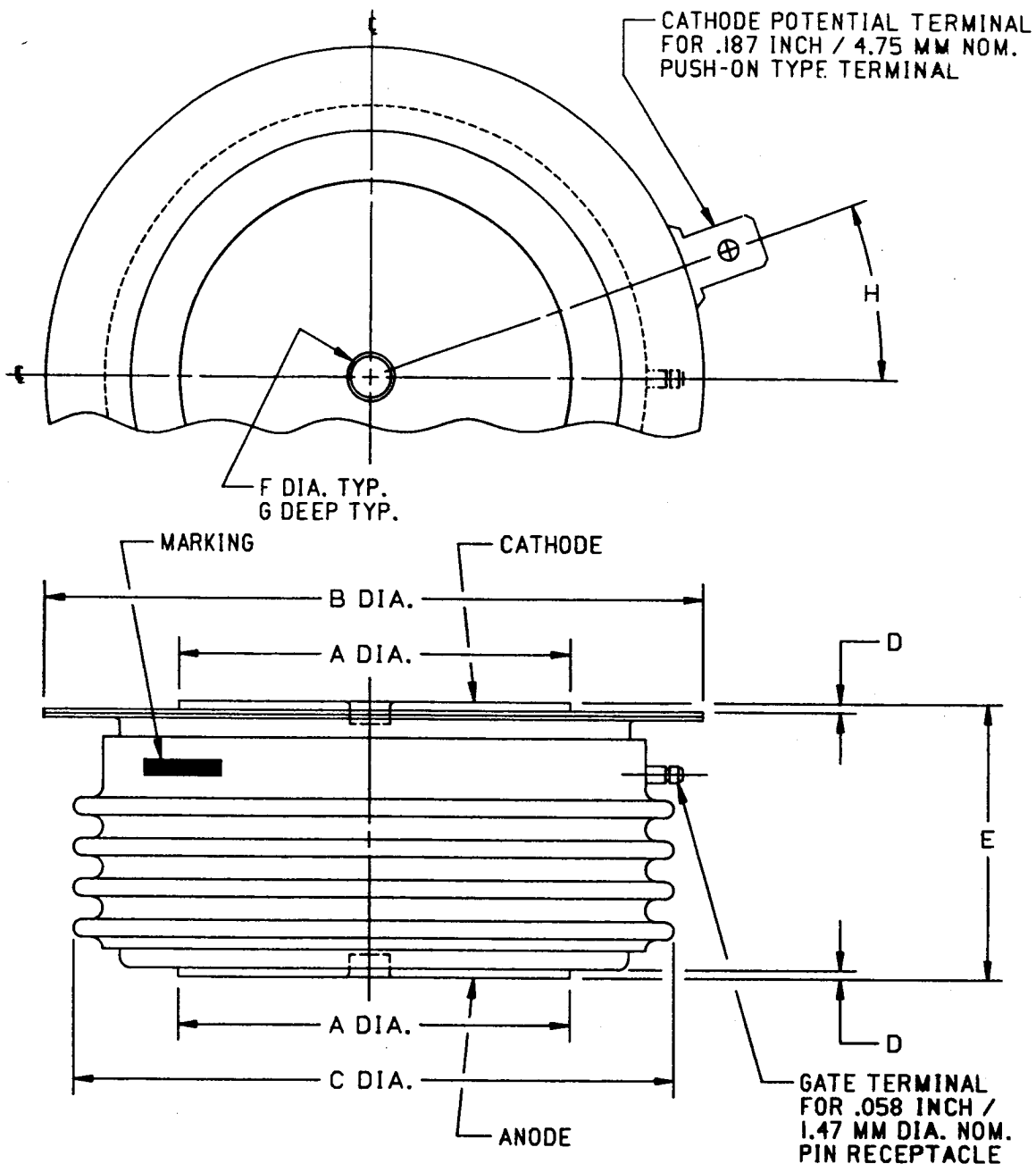

CASE NUMBER T72
 NOMINAL DIMENSIONS

STRIKE DISTANCE = .58 INCH / 14.7 MM MIN.
 CREEPAGE DISTANCE = 1.00 INCH / 25.4 MM MIN.

SYM.	A	B	C	D	E	F	G	H
INCHES	1.34	2.28	2.05	.030	1.020/1.060	.140	.080	20°
MM	34.0	57.9	52.1	0.76	25.91/26.92	3.56	2.03	20°

ALL DIMENSIONS ARE REFERENCE