

LeCroy

**USB 2.0
Compliance Test Software**

Operator's Manual

May 2005



LeCroy Corporation

700 Chestnut Ridge Road
Chestnut Ridge, NY 10977-6499
Tel: (845) 578 6020, Fax: (845) 578 5985

Internet: www.lecroy.com

© 2005 by LeCroy Corporation. All rights reserved.

LeCroy, ActiveDSO, ProBus, SMART Trigger, JitterTrack, WavePro, WaveMaster, WaveSurfer, and Waverunner are registered trademarks of LeCroy Corporation. Information in this publication supersedes all earlier versions. Specifications subject to change without notice.

Manufactured under an ISO 9000
Registered Quality Management System

Visit www.lecroy.com to view the
certificate



This electronic product is subject to disposal and recycling regulations that vary by country and region. Many countries prohibit the disposal of waste electronic equipment in standard waste receptacles.

For more information about proper disposal and recycling of your LeCroy product, please visit www.lecroy.com/recycle.

USB2-OM-E Rev D
903076

Table of Contents

INTRODUCTION	3
Host tests.....	3
Device tests.....	3
Hub tests.....	4
Equipment list.....	5
USB Test Fixture.....	5
INSTALLATION	7
USB-IF Test Scripts.....	7
Test Bed Computer.....	7
MATLAB.....	8
USB Test Wizard and HS Test Tool.....	8
HIGH SPEED SIGNAL QUALITY	13
Host and Hub Downstream High Speed Signal Quality.....	13
Hub and Device Upstream High Speed Signal Quality.....	14
HIGH SPEED PACKET PARAMETERS	16
HIGH-SPEED CHIRP TIMING	18
Host High Speed Chirp Timing.....	18
Device and Hub High Speed Chirp Timing.....	22
HIGH SPEED SUSPEND RESUME RESET TIMING	23
Host High Speed Suspend Resume Reset Timing.....	23
Device High Speed Suspend Resume Reset.....	26
Hub High Speed Suspend Resume Reset Timing.....	30
HOST AND HUB DISCONNECT	34
HUB HIGH SPEED UPSTREAM REPEATER	37
HUB HIGH SPEED DOWNSTREAM REPEATER	40
RECEIVER SENSITIVITY	43
FULL AND LOW SPEED TESTS	48
Equipment requirements.....	48
Standard USB products.....	48
Standard Test Equipment.....	49
Hub and Host Drop Test.....	50
Self-powered Hubs or Hosts.....	50
Bus-powered Hubs.....	51
Test Criteria.....	51

Droop test.....	52
Test Steps.....	52
Test Criteria	53
Test Results	54
Reporting Results	54
Host Low Speed Downstream Signal Quality	54
Host Full Speed Downstream Signal Quality	56
Inrush current	58
Hub Down Stream Low Speed Signal Quality.....	60
Hub Full Speed Downstream Signal Quality	62
Device and Hub Full Speed Upstream Signal Quality Test.....	63

INTRODUCTION

USB2 is an automated test package that performs all of the required tests from the USB-IF for physical layer compliance of USB2.0 hosts, hubs, and devices. The package consists of software that runs within the LeCroy WavePro 7000A series, WaveMaster, SDA, or WaveRunner 6000A series of X-Stream digitizing oscilloscopes, and an optional test fixture that allows you to couple into the electrical USB signals.

The software and fixture combine to perform the following measurements for USB2.0 hosts, hubs, and devices:

Host tests

- HS signal quality
- HS packet parameters
- HS chirp timing
- HS suspend/resume/reset
- HS disconnect
- FS downstream signal quality
- LS downstream signal quality

Device tests

- HS signal quality
- HS Far-end for tethered devices
- HS Near-end for untethered devices
- HS packet parameters
- HS chirp timing
- HS suspend/resume/reset
- HS Receiver Sensitivity
- FS upstream signal quality
- LS upstream signal quality (USB 1.1 devices only)
- Inrush current.

Hub tests

- HS signal quality (Upstream/Downstream)
 - HS Far-end for tethered hubs
 - HS Near-end for untethered hubs
- HS packet parameters
- HS chirp timing
- HS suspend/resume/reset
- HS Receiver Sensitivity
- HS Downstream Repeater
- HS Upstream Repeater
- FS signal quality (upstream/downstream)
- LS signal quality (upstream/downstream)
- Inrush current.

In addition to the above tests, the J/K, SE0_NAK test can be performed with the use of a digital voltmeter. This test is performed for Hosts, Devices, and Hubs.

Receiver sensitivity for devices requires the use of a data generator to produce “IN” packets. This manual describes the use of both the Agilent 81130A pulse generator and the Tektronix DG2040A for this test, although other instruments can also be used.

The USB package is invoked by selecting **Analysis** from the menu bar, then **USB2** from the drop-down menu. Once invoked, the USB2.0 test menu will appear at the bottom of the instrument display. This menu serves both to control the various measurement modes and to guide the operator through the steps of the test procedure. The **Next**, **Previous**, and **Reset** buttons navigate through each measurement. Specific measurements are selected from the **Mode** and **Test** controls.

As the test procedure is followed by the software, setup panels are recalled automatically for each test and mode. These setup files are provided with the test software and are automatically installed in the **D:\Applications\USB2\Setups** directory. In addition to the setup directory, there is a results directory created at **D:\Applications\USB2\Results**. The “Results” directory contains measurement result files for Inrush and Signal Quality measurements.

Equipment list

USB testing requires a number of probes as well as additional USB devices. The high-speed receiver sensitivity test requires a digital pattern generator. The following equipment is required for high-speed, full-speed, and low-speed USB testing:

- WaveRunner 6200A, WavePro7200A or better, WaveMaster 8300A or better or SDA
- USB test fixture (LeCroy TF-USB)
- 2 GHz or higher bandwidth active differential probe (LeCroy D350ST-SP, 2 ea.)
- 2 GHz active probe (LeCroy HFP2500, 2 ea.)
- 1 GHz or lower bandwidth active probe (HFP1000) or passive probe (PP006A) or equivalent)
- Current probe (LeCroy CP015)
- Certified high-speed USB Hub (self-powered)
- Self-powered full-speed hubs (5 ea.)
- 5 meter USB cables (6 ea.)
- Low-speed trigger device (USB mouse)
- Full-speed trigger device (USB web camera)

USB Test Fixture

The USB test fixture (TF-USB) is required to perform compliance tests. The fixture consists of several sections designed to allow connection to the electrical signal under test. Each section is marked on the fixture, and the ports on each section are also labeled. The section and port(s) to use for a given test are called out in the procedure on the instrument display and in this manual.

To operate, the fixture requires a 5 V power supply, which is provided with the fixture. The USB test fixture has square pins that provide connection points for differential and single-ended probes. The pins are connected to the “+” and “-“ signal lines and a pair of ground pins are also provided.

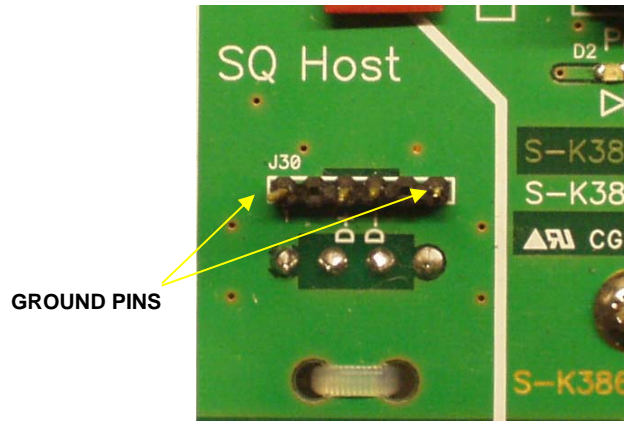

Probe Connection Pins Showing Grounds

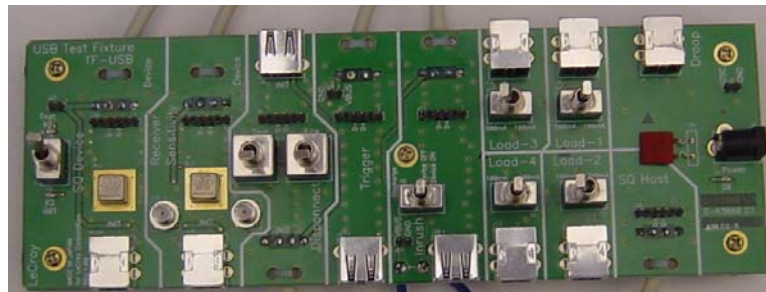

USB 2.0 Test Fixture (Part Number TF-USB)

INSTALLATION

NOTE: The USB-IF High Speed Test Tool scripts must be installed on the host computer or oscilloscope in order for the MATLAB scripts to operate correctly. These scripts are periodically updated by the USB-IF to incorporate any changes to the specifications. Always verify that you are using the latest version of these scripts.

USB-IF Test Scripts

The test package uses test scripts that have been written by the USB-IF specifically for analyzing test data acquired by the oscilloscope. These scripts are used by the test software and are installed in **D:\Applications\USB2\Setups**. The software USBHSET.exe can be downloaded from the UFB-IF Web site by following this link:

<http://www.usb.org/developers/tools/USBHSET.exe>

The USB-IF software on both the host computer and oscilloscope is the same code downloaded from the USB-IF Web site. Download the file USBHSET.exe and execute it to install the software on your oscilloscope.

Test Bed Computer

A host computer with a USB2.0 controller card is required to run the USB compliance tests. This computer must be running Windows 2000 Professional or Windows XP, and have installed on it the USB-IF test suite described above. The instructions in the LeCroy test package will prompt you to execute specific functions within the USB High Speed Test Tool on the host computer for various tests. On certain model oscilloscopes from LeCroy, the four USB ports on the back of the instrument can be used as the test bed computer. It is, however, best practice to use an external host computer, separate from the oscilloscope, to run all the tests. To determine if your oscilloscope has the appropriate ports, from Explorer select **USB-IF Test Suite → USB HS Electrical Toolkit → HSElectricalTestTool.exe**. If the USB 2.0 ports are present, the main menu will appear:

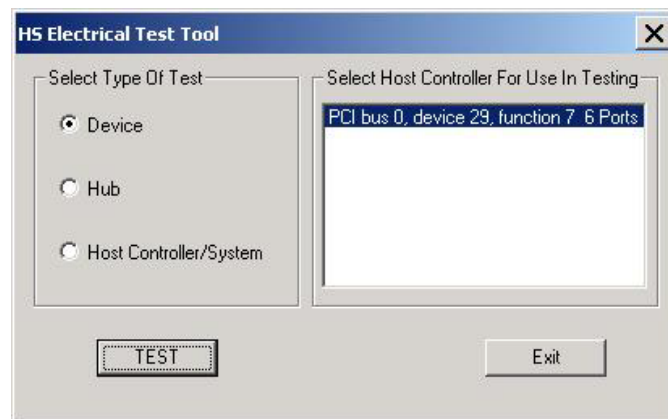

USB-IF HS Electrical Test Tool main menu

Note: If you are using a USB mouse, it will be disabled (signified by a tone). Use keyboard keys to navigate through the HS Electrical Test Tool menu. Mouse functionality will be restored upon exiting the Test Tool menu.

If this window does not appear or an error message is issued, then your scope does not have USB 2.0 ports, and an external host computer is necessary.

MATLAB

Effective with X-Stream version 4.3.1, the LeCroy USB2.0 test suite no longer requires a full installation of MATLAB software. MATLAB scripts are used to perform signal quality tests.

USB Test Wizard and HS Test Tool

The LeCroy USB test software (USB2) provides a “test wizard” to guide you through the compliance test procedure for hosts, hubs, and devices. The USB Test Wizard is activated by selecting USB2 from the **Analysis** menu of the oscilloscope:

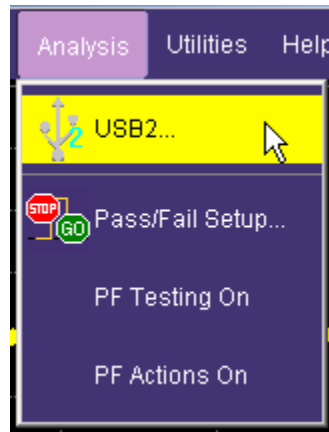

The wizard dialog page shown in the image below asks you to set the **Mode** and **Test** controls and guides you through the test. The tests must be followed step by step and cannot be skipped. Following the instructions closely will guarantee the success of the test. Once a test is selected from the **Test** menu, the instruction will reset to Step 1. Use the **Next** button to continue to the next step. Use the **Back** button to redo the previous step. Use the **Reset** button to do the test over again from Step 1.

USB2 Software Option

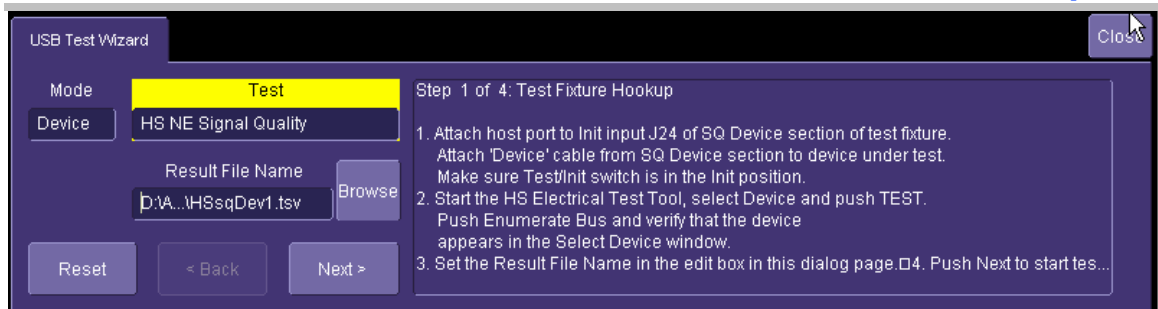

Device test High Speed Near End Signal Quality

The above image shows an example of Step 1 of 4 for **Device test High Speed Near End Signal Quality**. The first instructions tell you to hook up the USB device, host, and cables to the USB test fixture.

The following image demonstrates a USB device (camera) connected to the Device SQ cable of the test fixture (left), while the host cable is connected to init input J24 (right)



Step 2 instructs you to connect the probe between the scope and the test fixture:

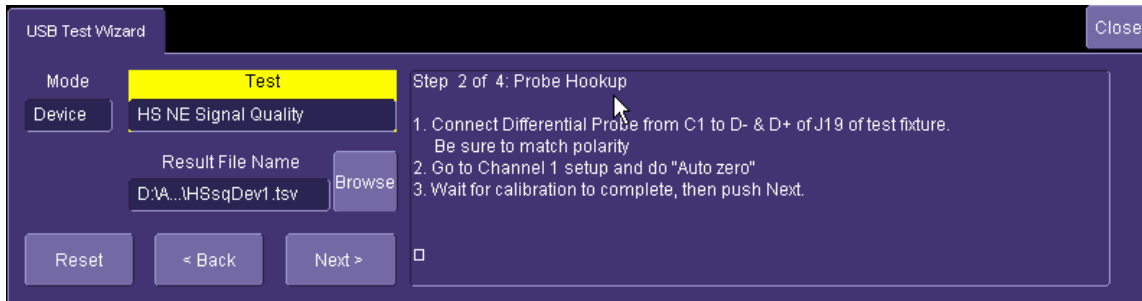

Step 2 of 4: Probe Hookup

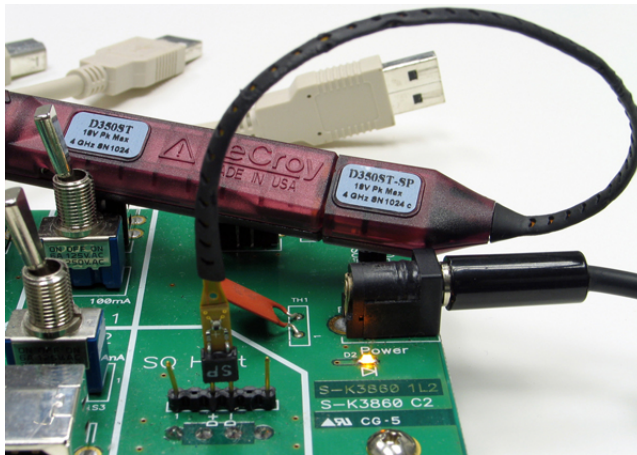

D350ST-SP Differential Probe Connected to the Test Fixture

USB2 Software Option

Some of the tests will require an active single-ended probe hookup. The following image shows a typical hookup of a single-ended probe. Make sure that the lower tip socket of the probe is connected to the ground pin of the test fixture.

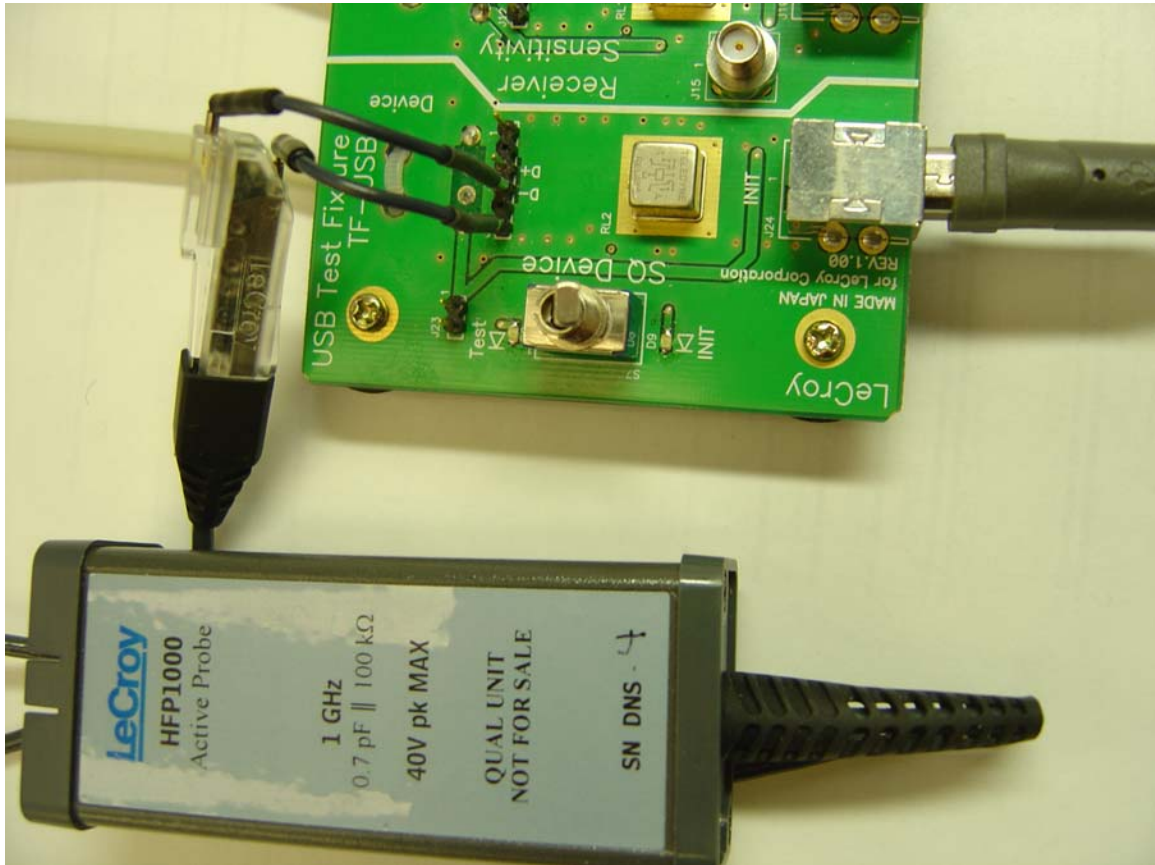

Active Probe Hookup Example

Step 3 instructs you to set up the HS Electrical Test Tool that generates the test signal:

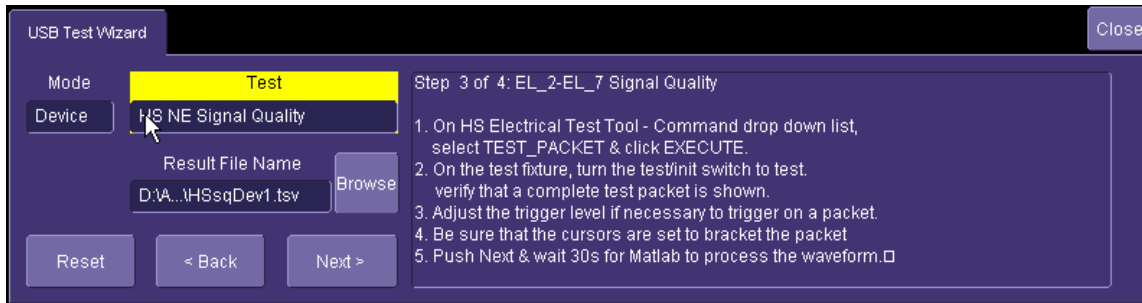

Step 3 of 4: EL_2-EL_7 Signal Quality

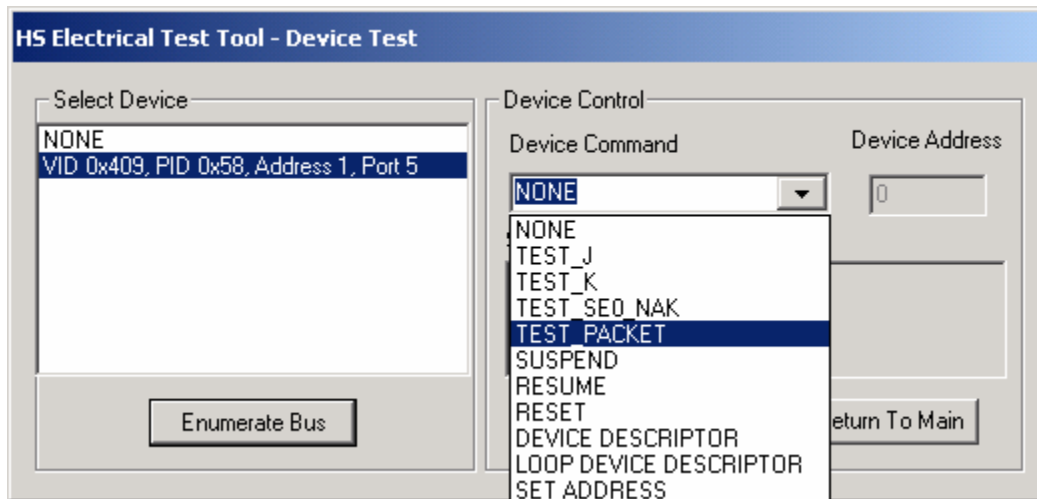

HS Electrical Test Tool Setup for Device High Speed Signal Quality

HIGH SPEED SIGNAL QUALITY

Host and Hub Downstream High Speed Signal Quality

1. Select **Host** or **Hub** in the “Mode” control and **HS Downstream Signal Quality** in the “Test” control of the USB Test Wizard.
2. Follow the instructions on the right side of the menu. The host port is connected to the “SQ Host” section of the Test Fixture as shown below.
3. The differential probe connects to the square pins in this section of the fixture.

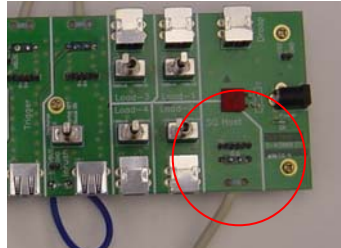

SQ Host Section of the USB Test Fixture

The captured waveform should appear as shown below. Cursors (dashed vertical lines in the image) must be placed on either side of the packet as shown. Use the **CURSORS** knobs on the oscilloscope’s front panel to adjust the position of the cursors if necessary. The waveform between the cursors is processed by the USB-IF signal quality test script to obtain an eye pattern and jitter measurements.

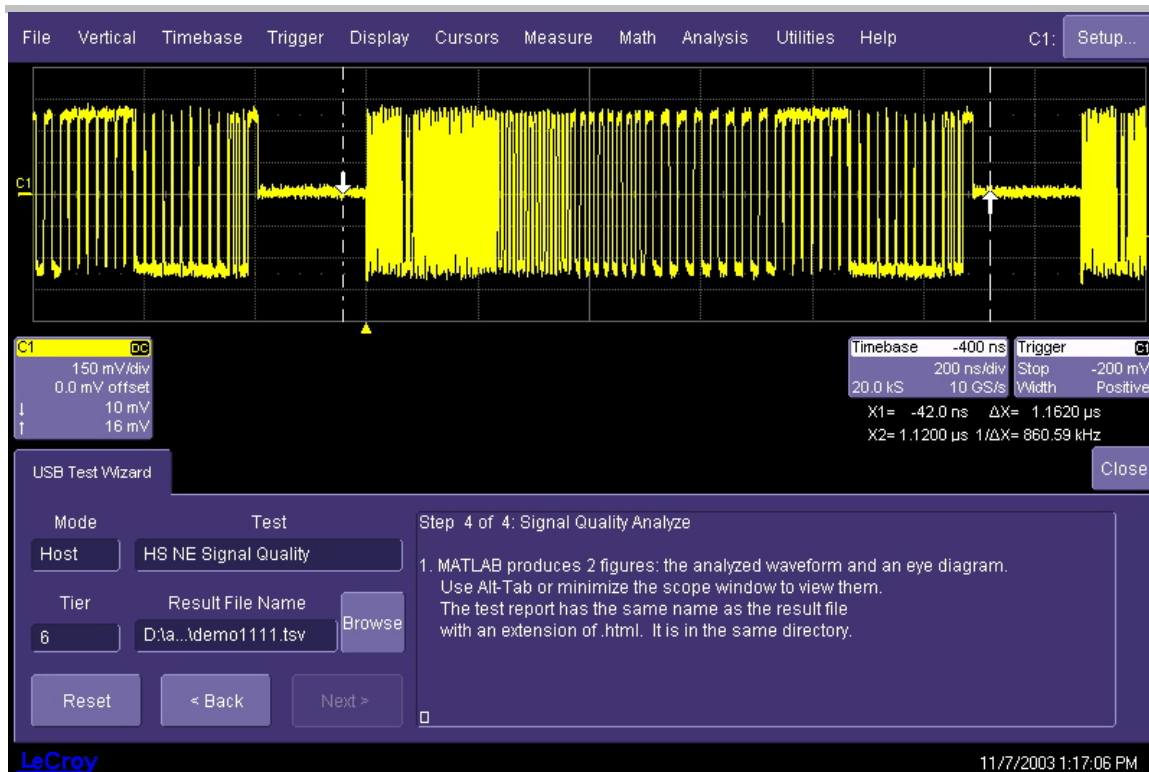

Device and Hub Upstream High Speed Signal Quality

Select the appropriate mode (device or hub) and test (signal quality for device or upstream signal quality for hub) in the USB test wizard. The device or hub upstream port is connected to the host computer through the [SQ Device] section of the Test Fixture.

Note: Select **Device HS Upstream NE Signal Quality** for a device without a captive cable. Select **Device HS Upstream FE Signal Quality** for a device with a captive cable.

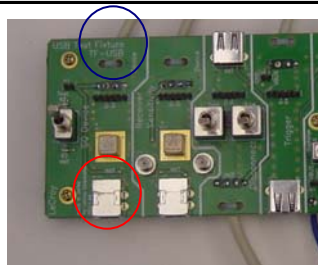

Connections for device or hub upstream signal quality. The host computer connects to the [init] port (red circle) and the device or hub upstream port is attached to the test cable (blue circle).

USB2 Software Option

The captured waveform should appear as shown below (shown for the device test). Cursors (dashed vertical lines in the image) must appear on either side of the packet, as shown. Use the **CURSORS** knobs on the oscilloscope's front panel to adjust the position of the cursors, if necessary. The waveform between the cursors is processed by the USB-IF signal quality test script to obtain an eye pattern and jitter measurements.

Note: After the device or hub upstream signal quality test is completed, the power to the device or hub must be cycled in order to stop the transmission of the test packets. The device or hub will not respond to further test commands until the power is cycled.

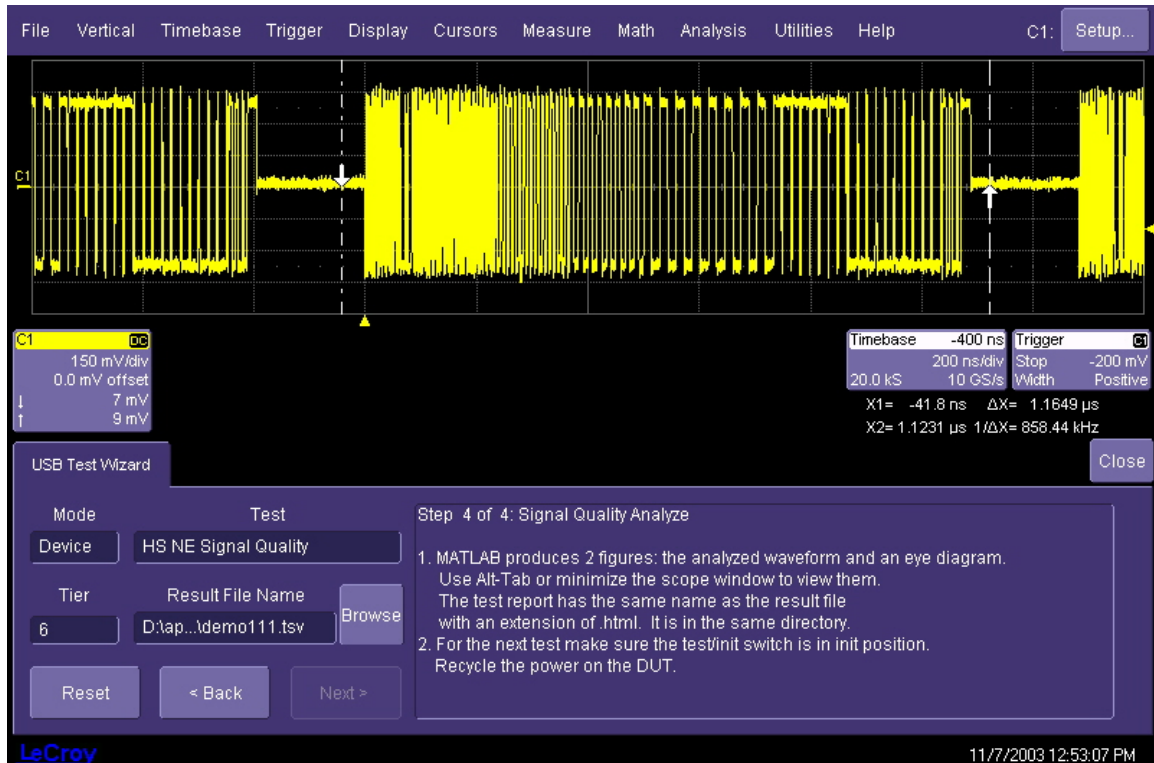

Hub and Device Upstream High Speed Signal Quality

HIGH SPEED PACKET PARAMETERS

Packet parameters represent timing measurements of the communications between host, hub, and device. USB2.0 transmits data in bi-directional packets. The timing of these packets is critical for proper communications. The sync field at the start of the packet and the width of the EOP (end of packet) as well as the inter-packet timing is measured in this test.

1. Select **Host, Hub, or Device** in the “Mode” control and **HS Packet Parameters** in the “Test” control of the USB Test Wizard.
2. Attach the host port to the INIT port of the “SQ Device” section of the Test Fixture.
3. Attach the high-speed device (for host or device testing) or the hub under test (for hub tests) to the test port.

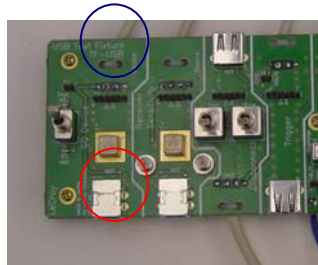

Fixture connections for high-speed packet parameters. The host computer connects to the INIT port (red circle) and the device or hub is attached to the test cable (blue circle)

4. Follow the instructions in the USB Test Wizard menu to acquire the waveform. The captured trace should look like the image below. The burst in the center of the upper display contains three packets. This test measures the sync field and EOP width of the center packet, and two time intervals between the three packets.

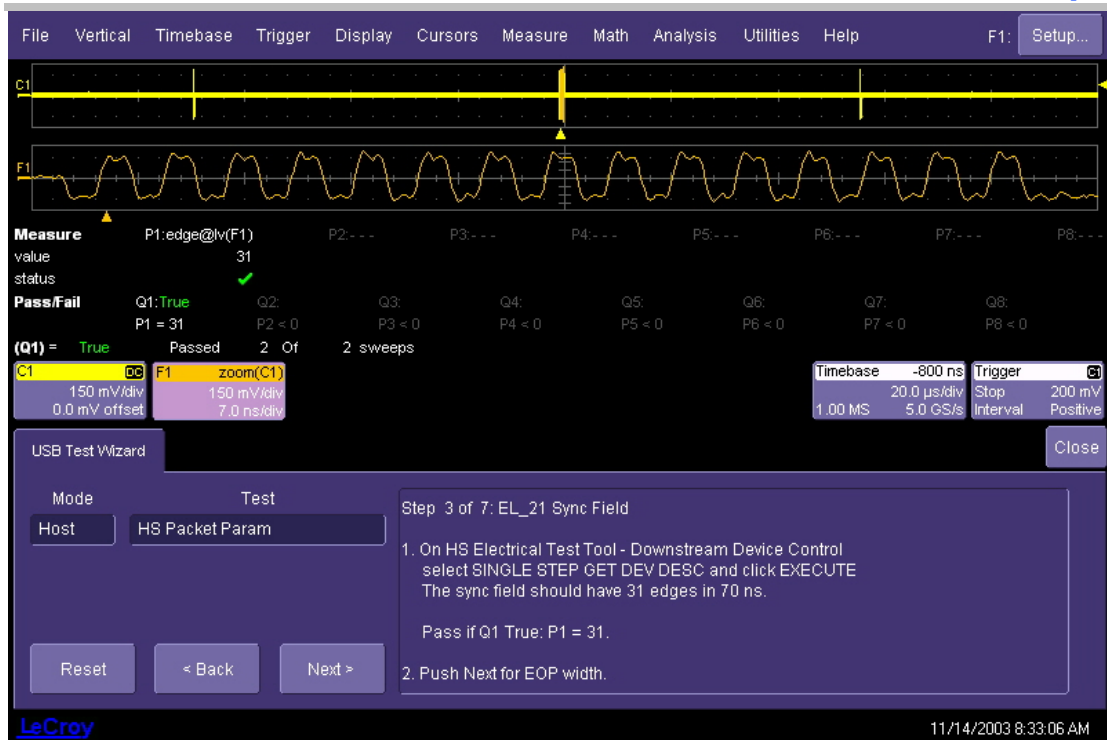

Host high-speed packet parameters trace. The image shown is for a Host test, but the waveform will look the same for Hub and Device tests as well.

HIGH-SPEED CHIRP TIMING

A high-speed USB port must also be compatible with full-speed operation (12 Mb/s). High-speed operation is detected using the K and J chirp sequences. Full-speed operation uses a higher impedance load. When a HS capable host asserts a reset, a HS capable device must respond with the Chirp K to signal HS support. The Host then responds with a Chirp J/K sequence to signal HS support as well. This test measures the timing and voltages of the HS handshake. The “SQ Device” section of the Test Fixture is used for chirp timing measurements.

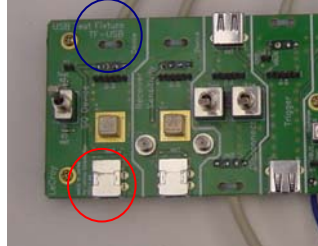

Fixture connections for high-speed chirp timing. The host computer connects to the INIT port (red circle) and the device or hub is attached to the test cable (blue circle)

Host High Speed Chirp Timing

1. Select **Host** in the “Mode” control and **HS Chirp Timing** in the “Test” control of the USB Test Wizard.
2. Connect the host to the INIT port of the “SQ Device” section of the fixture.
3. Follow the instructions in the wizard menu to acquire the chirp timing waveforms. Three waveforms will be acquired, as shown below:

USB2 Software Option

The screenshot displays a LaCroy oscilloscope interface with two waveforms. The top waveform, labeled 'C2', shows a signal with a 'CHIRP K DURATION' indicated by a double-headed arrow. The bottom waveform, labeled 'F1', shows a signal with a 'P1 MEASUREMENT' indicated by a double-headed arrow. Below the waveforms is a 'Measure' section with the following data:

Measure	P1: M@x(F1)	P2: max(F4)	P3: (P5-P4)	P4: time@v(F3)	P5: time@v(F2)	P6: time@v(F3)	P7: ---	P8: ---
value	28.023 μ s							
status	✓							

Below the measure section is a 'Pass/Fail' section with the following data:

Pass/Fail	Q1: True	Q2:	Q3:	Q4:	Q5:	Q6:	Q7:	Q8:
	P1 < 100 μ s	P2 = 4 ms	P3 < 500 μ s	P4 < 0	P5 < 0	P6 < 0	P7 < 0	P8 < 0

Below the pass/fail section is a 'USB Test Wizard' window. The 'Mode' is set to 'Test' and the 'Host' is set to 'HS Chirp Timing'. The wizard is at 'Step 3 of 5: EL_33 Chirp Response Time'. The instructions are:

1. Wait for calibration to complete.
2. On HS Electrical Test Tool, push Enumerate Bus. P1 is the Host's chirp response time. Pass if Q1 True: P1 < 100 μ s.
3. Unplug and replug the certified HS device, then push Next for Chirp-K & Chirp-J duration.

The bottom of the screen shows the LaCroy logo and the date/time: 4/22/2005 10:54:15 AM.

File Vertical Timebase Trigger Display Cursors Measure Math Analysis Utilities Help F2: Setup...

Measure

	P1:wid@lv(C3)	P2:wid@lv(C3)	P3:time@lv(C2)	P4:max(F2)	P5:max(F3)	P6:---	P7:---	P8:---
value	41.4236 μ s	42.5766 μ s						
mean	41.424430 μ s	42.575816 μ s						
min	41.4236 μ s	42.5751 μ s						
max	41.4253 μ s	42.5766 μ s						
sdev	867 ps	754 ps						
num	2	2						
status	✓	✓						

Pass/Fail

	Q1:True	Q2:True	Q3:	Q4:	Q5:	Q6:	Q7:	Q8:
	P1 \approx 50 μ s	P2 \approx 50 μ s	P3 < 500 μ s	P4 < 0	P5 < 0	P6 < 0	P7 < 0	P8 < 0
(Q1 & Q2) = True	Passed	1 Of	1 sweeps					

C3 500 mV/div -250 mV offset

Timebase 100 μ s Trigger C3
 12.5 kS 50.0 μ s/div Stop 500 mV
 25 MS/s Width Positive

USB Test Wizard Close

Mode **Test** Step 4 of 5: EL_34 Chirp JK Duration
 Host HS Chirp Timing

1. Wait for calibration to complete, then press Enumerate Bus on HS Electrical Test Tool. P1 is the Chirp-J duration, P2 is the Chirp-K duration.
 Pass if Q1 and Q2 True: 40 μ s < P1 < 60 μ s and 40 μ s < P2 < 60 μ s.
2. Unplug and replug the certified device then push Next for Chirp J/K SOF time.

Reset < Back Next >

LeCroy 11/14/2003 9:15:08 AM

USB2 Software Option

File Vertical Timebase Trigger Display Cursors Measure Math Analysis Utilities Help C2: Setup...

Measure
 P1: max(F1) P2: max(F2) P3: MinMax(P1,P...
 value 181.0132 μs
 status ✓

Pass/Fail
 Q1: True Q2: Q3: Q4: Q5: Q6: Q7: Q8:
 P3 ≈ 300 μs P2 ≈ 50 μs P3 < 500 μs P4 < 0 P5 < 0 P6 < 0 P7 < 0 P8 < 0

(Q1) = True Passed 1 Of 1 sweeps

C2	DC	C3	DC	Timebase	450 μs	Trigger	C3
100 mV/div		100 mV/div		500 kS	100 μs/div	Stop	200 mV
-200.2 mV ofst		-200.2 mV ofst			500 MS/s	Interval	Negative

USB Test Wizard Close

Mode **Test**
 Host HS Chirp Timing

Step 5 of 5: EL_35 Chirp JK->SOF Time

1. Wait for calibration to complete, then press Enumerate Bus on HS Electrical Test Tool. P3 is the Chirp JK to Start of Frame time.

Pass if Q1 True: 100 < P3 < 500 us.

Reset < Back Next >

LeCroy 11/14/2003 9:16:16 AM

Device and Hub High Speed Chirp Timing

1. Select **Device** or **Hub** in the “Mode” control and **HS Chirp Timing** in the “Test” control of the USB Test Wizard.
2. Connect the host to the INIT port of the “SQ Device” section of the Test Fixture.
3. Follow the instructions in the wizard menu to acquire the chirp timing waveform. The chirp waveform should look like the image below:

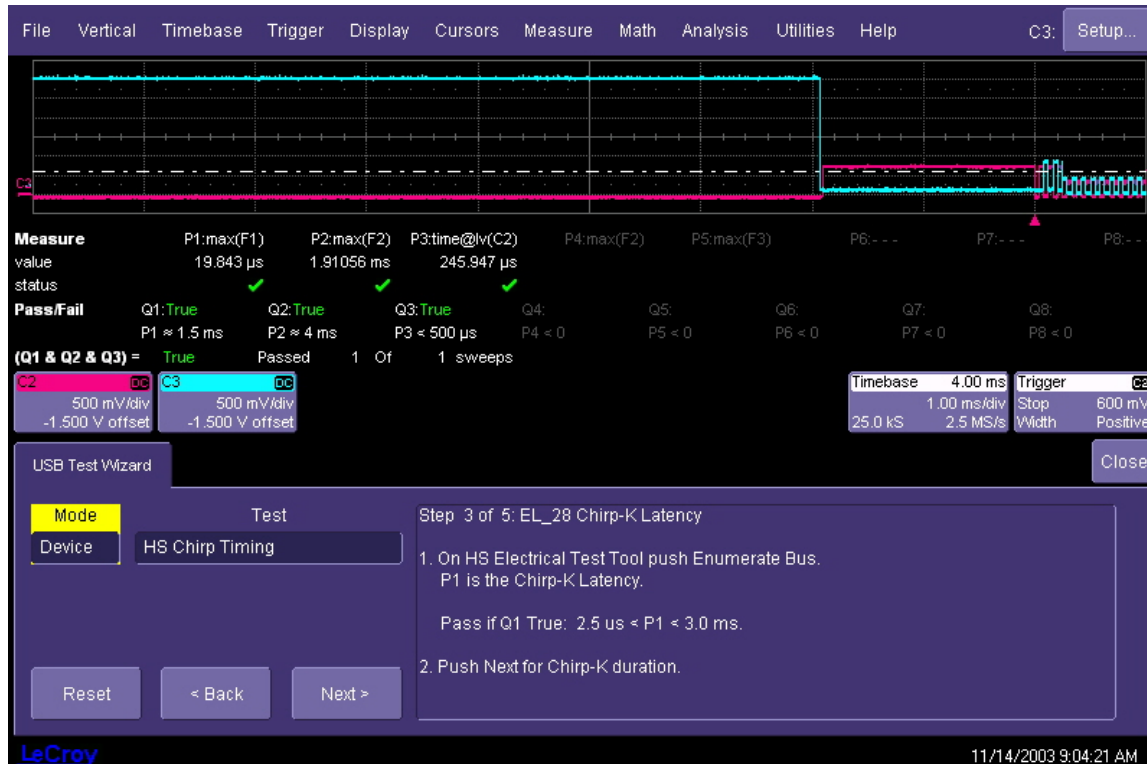

HIGH SPEED SUSPEND RESUME RESET TIMING

Host High Speed Suspend Resume Reset Timing

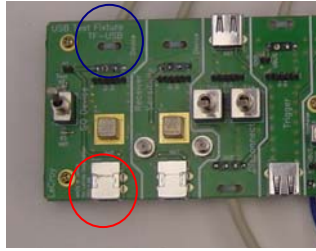

Fixture connections for suspend resume reset timing. The host computer connects to the INIT port (red circle) and the device or hub is attached to the test cable (blue circle)

1. Select **Host** in the “Mode” control and **HS Suspend Resume Reset** in the USB Test Wizard.
2. Connect the host to the INIT port of the “SQ Device” and the device or hub to the test port of the “SQ Device” section of the Test Fixture.
3. Follow the instructions on the screen to acquire the suspend and reset timing waveforms, as pictured below:

File Vertical Timebase Trigger Display Cursors Measure Math Analysis Utilities Help P1: Setup...

Measure
 value P1:hold(C2,C3) P2:mean(C3) P3:time@lv(C2) P4:max(F2) P5:max(F3) P6:--- P7:--- P8:---
 3.01974680 ms
 status

Pass/Fail
 Q1:True Q2: Q3: Q4: Q5: Q6: Q7: Q8:
 P1 ≈ 4.5 ms P2 ≈ 3.15 V P3 < 500 μs P4 < 0 P5 < 0 P6 < 0 P7 < 0 P8 < 0

(Q1) = True Passed 1 Of 1 sweeps

C2	200 mV/div	C3	500 mV/div	Timebase	1.50 ms	Trigger	C3
	-585.1 mV offset		-1.503 V offset		500 μs/div	Stop	1.500 V
					1.00 MS	Edge	Positive

USB Test Wizard Close

Mode Test Step 3 of 4: EL_39 Host Suspend Time

Host HS Suspend Resume Reset

1. On HS Electrical Test Tool select SUSPEND from Port Control, set the port number and then push EXECUTE. P1 is the time between HS and Suspend modes.

Pass if Q1 True: 3.0 ms < P1 < 3.125ms.

2. Push Next for Suspend-Resume time.

Reset < Back Next >

LeCroy 11/14/2003 10:25:54 AM

USB2 Software Option

The screenshot displays a LeCroy oscilloscope interface with a USB signal waveform. The waveform shows a series of pulses, with a red cursor marking a specific point. Below the waveform, the 'Measure' section shows a value of 19.663 μs for P1: max(F1). The 'Pass/Fail' section indicates that the test passed (Q1: True) and that the measured value (P1 ≈ 3 ms) is within the specified limit (P1 < 3 ms). The 'USB Test Wizard' dialog box is open, showing the test mode as 'Host' and the test as 'HS Suspend Resume Reset'. The wizard is at Step 4 of 4, titled 'EL_41 Host Reset time'. The instructions state: '1. On HS Electrical Test Tool select RESUME from Port Control and then push EXECUTE. P1 is the time from the end of suspend and the first SOF from the host. Pass if Q1 True: P1 < 3 ms. Perform several SUSPEND/EXECUTE - RESUME/EXECUTE cycles on the HS Tool and verify that the suspend - SOF time never exceeds 3 ms.' The LeCroy logo is visible in the bottom left corner, and a 'Waiting for Trigger' indicator is in the bottom right corner.

File Vertical Timebase Trigger Display Cursors Measure Math Analysis Utilities Help C3: Setup...

Measure
value
status
Pass/Fail
(Q1) = True
C2: 500 mV/div, -1.500 V offset
C3: 500 mV/div, -1.503 V offset
Timebase: -200 μs, 1.00 MS
Trigger: C3, Normal, Edge, 1.500 V, Negative

USB Test Wizard
Mode: Host
Test: HS Suspend Resume Reset
Step 4 of 4: EL_41 Host Reset time
1. On HS Electrical Test Tool select RESUME from Port Control and then push EXECUTE. P1 is the time from the end of suspend and the first SOF from the host.
Pass if Q1 True: P1 < 3 ms.
Perform several SUSPEND/EXECUTE - RESUME/EXECUTE cycles on the HS Tool and verify that the suspend - SOF time never exceeds 3 ms.
Reset < Back Next > Close
LeCroy Waiting for Trigger

Device High Speed Suspend Resume Reset

The resume test measures the peak-to-peak voltage of the device after being reset to high-speed operation. This voltage should be between 360 mV and 440 mV, which is the specified range from the USB2.0 specification. Since this measurement is intended to verify that the high-speed mode is entered, it is possible for a passing device to have a peak-to-peak voltage slightly outside this range.

1. Select **Device** in the “Mode” control and **HS Suspend Resume Reset** in the “Test” control of the USB Test Wizard.
2. Connect the host port to the INIT port of the “SQ Device” section of the Test Fixture and the device to the test port of the “SQ Device” section of the Test Fixture.
3. Follow the instructions in the USB Test Wizard to acquire traces for suspend, resume, reset; and reset from suspend functions. The traces should look like the images below:

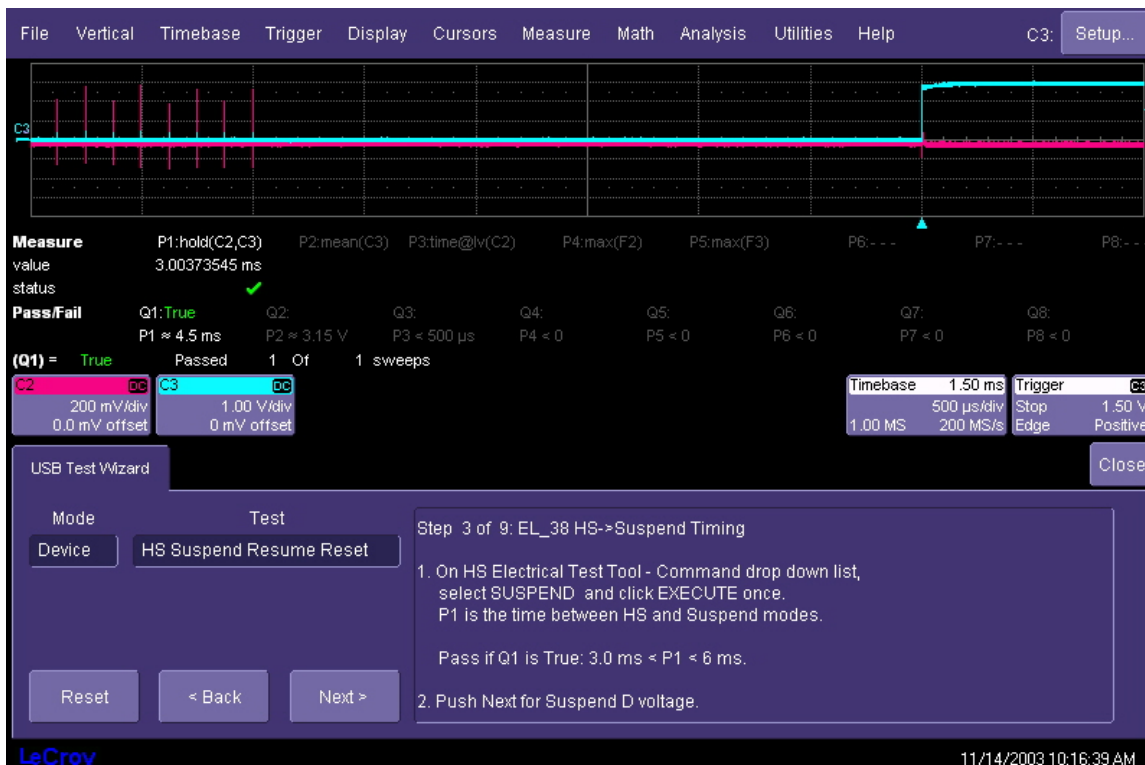

USB2 Software Option

The screenshot displays a LeCroy oscilloscope interface with a USB signal waveform. The main window shows a menu bar (File, Vertical, Timebase, Trigger, Display, Cursors, Measure, Math, Analysis, Utilities, Help) and a toolbar with 'C3: Setup...'. The waveform shows a signal with a red vertical cursor at the start of a pulse. Below the waveform, the 'Measure' section shows 'P1:max(C3)' with a value of 375 mV and a status of 'Pass'. The 'Pass/Fail' section shows 'Q1: True' and 'Passed 1 Of 1 sweeps'. The 'USB Test Wizard' dialog box is open, showing 'Mode: Device' and 'Test: HS Suspend Resume Reset'. The wizard is at 'Step 5 of 9: EL_40 Resume Voltage' and provides instructions for the test. The LeCroy logo and the date '11/14/2003 12:39:23 PM' are visible at the bottom.

Measure

P1:max(C3)	P2:mean(C3)	P3:time@v(C2)	P4:max(F2)	P5:max(F3)	P6:--	P7:--	P8:--
value	375 mV						
status	Pass						

Pass/Fail

Q1: True	Q2:	Q3:	Q4:	Q5:	Q6:	Q7:	Q8:
P1 ≈ 400 mV	P2 ≈ 3.15 V	P3 < 500 μs	P4 < 0	P5 < 0	P6 < 0	P7 < 0	P8 < 0

(Q1) = True Passed 1 Of 1 sweeps

C2 BwLDC 500 mV/div -1.500 V offset

C3 BwLDC 500 mV/div -1.503 V offset

Timebase -400 μs 25.0 kS

Trigger C3 100 μs/div 25 MS/s Stop 750 mV Edge Negative

USB Test Wizard Close

Mode: Device Test: HS Suspend Resume Reset

Step 5 of 9: EL_40 Resume Voltage

- On HS Electrical Test Tool - Command drop down list, select RESUME and click EXECUTE once. P1 is the maximum voltage of the SOF signals
- Click Enumerate Bus on HS Electrical Test Tool and push Next for Reset timing.

Pass if Q1 True: 360mV < P1 < 440 mV.

Reset < Back Next >

LeCroy 11/14/2003 12:39:23 PM

File Vertical Timebase Trigger Display Cursors Measure Math Analysis Utilities Help C3: Setup...

Measure

P1:hold(C3,C2)	P2:mean(C3)	P3:time@lv(C2)	P4:max(F2)	P5:max(F3)	P6:---	P7:---	P8:---
value	3.8218327 ms						
status							

Pass/Fail

Q1:True	Q2:	Q3:	Q4:	Q5:	Q6:	Q7:	Q8:
P1 ≈ 4.55 ms	P2 ≈ 3.15 V	P3 < 500 μs	P4 < 0	P5 < 0	P6 < 0	P7 < 0	P8 < 0

(Q1) = True Passed 1 Of 1 sweeps

C2	C3	Timebase	4.00 ms	Trigger	C3
200 mV/div	200 mV/div	1.00 ms/div	100 MS/s	Stop	700 mV
-600.2 mV orst	-601.0 mV orst	1.00 MS		Edge	Positive

USB Test Wizard Close

Mode Test

Device HS Suspend Resume Reset

Step 6 of 9: EL_2 to EL_7 HS->Reset Timing

1. On HS Electrical Test Tool - Command drop down list, select RESET and click EXECUTE once.
2. Push NEXT to continue.

Reset < Back Next >

LeCroy 11/14/2003 10:18:35 AM

USB2 Software Option

The screenshot displays a LeCroy oscilloscope interface with a USB signal waveform. The waveform shows a transition from a high state to a low state, with a sharp edge. The interface includes a menu bar (File, Vertical, Timebase, Trigger, Display, Cursors, Measure, Math, Analysis, Utilities, Help) and a toolbar (C3: Setup...). Below the waveform, there are measurement and pass/fail data:

Measure	P1: max(F1)	P2: mean(C3)	P3: time@v(C2)	P4: max(F2)	P5: max(F3)	P6: --	P7: --	P8: --
value	19.250 μ s							
status	✓							

Below the measurements, there is a Pass/Fail section:

Pass/Fail	Q1: True	Q2:	Q3:	Q4:	Q5:	Q6:	Q7:	Q8:
	P1 \approx 1.5 ms	P2 \approx 3.15 V	P3 < 500 μ s	P4 < 0	P5 < 0	P6 < 0	P7 < 0	P8 < 0

The (Q1) status is True, and the test has Passed (1 Of 1 sweeps). The oscilloscope settings are:

Channel	Scale	Offset	Timebase	Trigger
C2	500 mV/div	-1.500 V offset	-2.00 ms	Stop
C3	500 mV/div	-1.503 V offset	500 μ s/div	Edge
			1.00 MS	1.500 V Negative

The USB Test Wizard dialog box is open, showing Step 9 of 9: EL_28 Suspend->Reset Timing. The Mode is Device and the Test is HS Suspend Resume Reset. The instructions are:

- On HS Electrical Test Tool - Command drop down list, select RESET and click EXECUTE. P1 is the time between Suspend and Reset modes.

Pass if Q1 True: 2.5 μ s < P1 < 3.0 ms.

Buttons: Reset, < Back, Next >, Close.

LeCroy logo and timestamp: 11/14/2003 10:20:23 AM

Hub High Speed Suspend Resume Reset Timing

The resume test measures the peak-to-peak voltage of the hub after being reset to high-speed operation. This voltage should be between 360 mV and 440 mV, which is the specified range from the USB2.0 specification. Since this measurement is intended to verify that the high-speed mode is entered, it is possible for a passing hub to have a peak-to-peak voltage slightly outside this range.

1. Select **Hub** in the “Mode” control and **HS Suspend Resume Reset** in the “Test” control.
2. Connect the host to the INIT port of the “SQ Device” section of the Test Fixture, and the upstream port of the hub under test to the test port of the “SQ Device” section of the Test Fixture.
3. Follow the instructions in the USB Test Wizard to acquire traces for suspend, resume, reset; and reset from suspend functions. The traces should look like the images below:

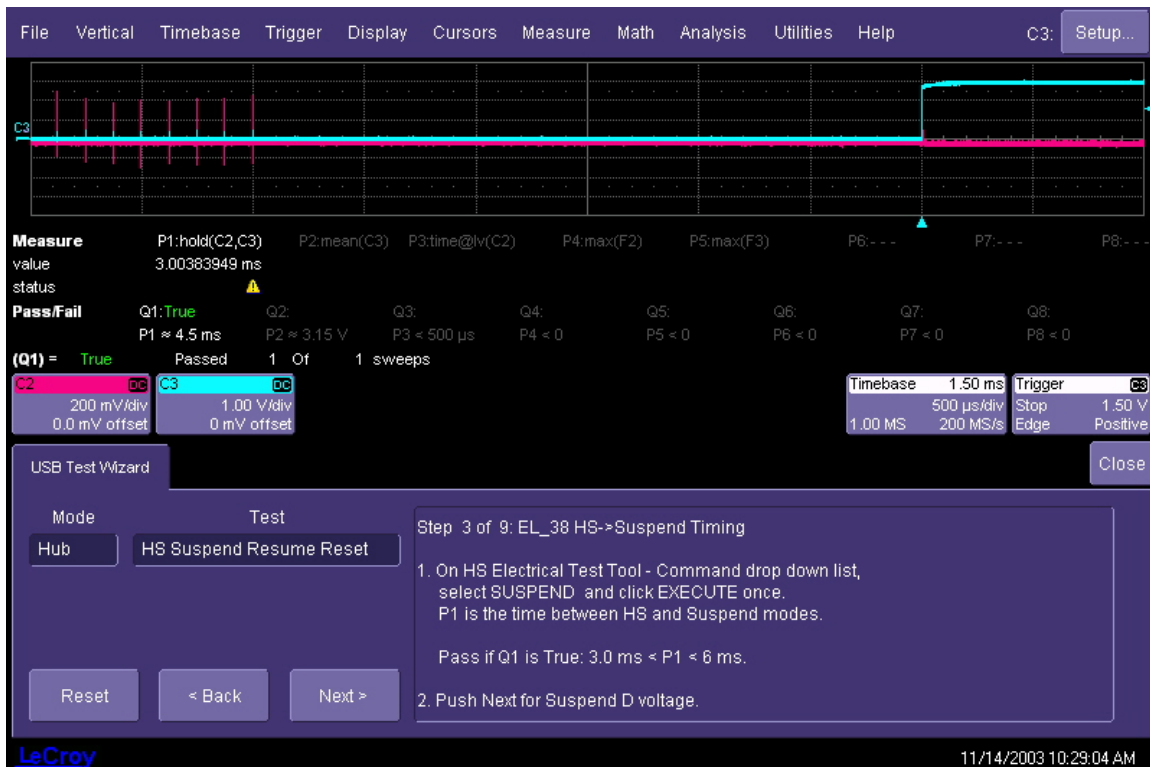

USB2 Software Option

File Vertical Timebase Trigger Display Cursors Measure Math Analysis Utilities Help C3: Setup...

Measure value P1: max(C3) 375 mV
 status P2: mean(C3) P3: time@v(C2) P4: max(F2) P5: max(F3) P6: -- P7: -- P8: --

Pass/Fail Q1: True Q2: Q3: Q4: Q5: Q6: Q7: Q8:
 P1 ≈ 400 mV P2 ≈ 3.15 V P3 < 500 μs P4 < 0 P5 < 0 P6 < 0 P7 < 0 P8 < 0

(Q1) = True Passed 1 Of 1 sweeps

C2: 500 mV/div -1.500 V offset
 C3: 500 mV/div -1.503 V offset

Timebase: -400 μs 25.0 kS
 Trigger: Stop 750 mV Edge Negative

USB Test Wizard Close

Mode: Hub Test: HS Suspend Resume Reset

Step 5 of 9: EL_40 Resume Voltage

- On HS Electrical Test Tool - Command drop down list, select RESUME and click EXECUTE once. P1 is the maximum voltage of the SOF signals
- Click Enumerate Bus on HS Electrical Test Tool and push Next for Reset timing.

Pass if Q1 True: 360mV < P1 < 440 mV.

Reset < Back Next >

LeCroy 11/14/2003 10:43:41 AM

File Vertical Timebase Trigger Display Cursors Measure Math Analysis Utilities Help C3: Setup...

Measure
 P1:hold(C3,C2) P2:mean(C3) P3:time@lv(C2) P4:max(F2) P5:max(F3) P6:-- P7:-- P8:--
 value 3.8218384 ms
 status ▲

Pass/Fail
 Q1:True Q2: Q3: Q4: Q5: Q6: Q7: Q8:
 P1 ≈ 4.55 ms P2 ≈ 3.15 V P3 < 500 μs P4 < 0 P5 < 0 P6 < 0 P7 < 0 P8 < 0

(Q1) = True Passed 1 Of 1 sweeps

C2	200 mV/div	C3	200 mV/div	Timebase	4.00 ms	Trigger	C3
	-600.2 mV ofst		-601.0 mV ofst		1.00 ms/div	Stop	700 mV
					1.00 MS	Edge	Positive

USB Test Wizard Close

Mode: Hub Test: HS Suspend Resume Reset

Step 6 of 9: EL_2 to EL_7 HS->Reset Timing

1. On HS Electrical Test Tool - Command drop down list, select RESET and click EXECUTE once.
2. Push Next to continue.

Reset < Back Next >

LeCroy 11/14/2003 10:44:17 AM

USB2 Software Option

File Vertical Timebase Trigger Display Cursors Measure Math Analysis Utilities Help C3: Setup...

Measure
 value: P1:max(F1) 19.314 μ s
 status: ✓

Pass/Fail
 Q1: True P1 \approx 1.5 ms Q2: P2 \approx 3.15 V Q3: P3 < 500 μ s Q4: P4 < 0 Q5: P5 < 0 Q6: P6 < 0 Q7: P7 < 0 Q8: P8 < 0

(Q1) = True Passed 1 Of 1 sweeps

C2: DC	C3: DC	Timebase: -2.00 ms	Trigger: C3
500 mV/div	500 mV/div	500 μ s/div	Stop 1.500 V
-1.500 V offset	-1.503 V offset	1.00 MS	Edge 200 MS/s

USB Test Wizard Close

Mode: Hub Test: HS Suspend Resume Reset

Step 9 of 9: EL_28 Suspend->Reset Timing

1. On HS Electrical Test Tool - Command drop down list, select RESET and click EXECUTE.
 P1 is the time between Suspend and Reset modes.

Pass if Q1 True: 2.5 μ s < P1 < 3.0 ms.

Reset < Back Next >

LeCroy 11/14/2003 10:45:32 AM

HOST AND HUB DISCONNECT

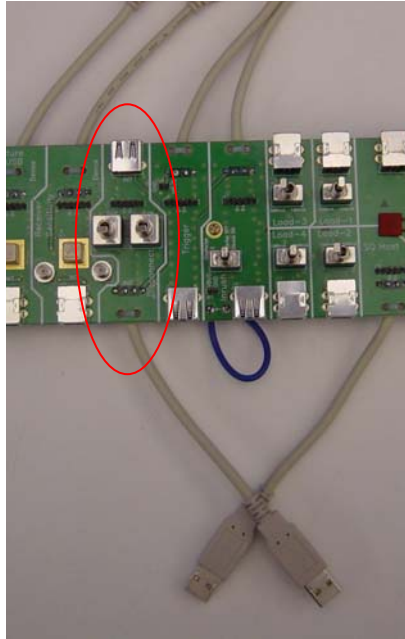

Host Disconnect Section of Test Fixture

1. Select **Host** or **Hub** in the “Mode” control and **HS Disconnect** in the “Test” control of the USB Test Wizard.
2. Attach the “Disconnect” INIT cable of the test fixture to the host port under test. Set switches **S1** and **S2** in the “Disconnect” section away from the **Test** and **Low** positions.
3. Follow the instructions in the USB Test Wizard to acquire and measure the disconnect voltages. The “disconnect detected” message is read from the USB-IF HS Electrical Test Tool dialog box. The traces for normal and disconnect should appear as shown in the images below.

USB2 Software Option

File Vertical Timebase Trigger Display Cursors Measure Math Analysis Utilities Help C1: Setup...

Measure P1:pkpk(C1) P2:mean(C3) P3:time@lv(C2) P4:max(F2) P5:max(F3) P6:--- P7:--- P8:---

value 990 mV
mean 984.0 mV
min 946 mV
max 1.03 V
sdev 12.3 mV
num 689
status

Pass/Fail Q1: True Q2: Q3: Q4: Q5: Q6: Q7: Q8:
P1 < 1.05 V P2 ≈ 3.15 V P3 < 500 μs P4 < 0 P5 < 0 P6 < 0 P7 < 0 P8 < 0

(Q1) = True Passed 689 Of 689 sweeps

C1 DC
200 mV/div
-199.8 mV ofst

Timebase 0 μs Trigger C1
100 μs/div Normal 400 mV
2.50 MS 2.5 GS/s Edge Positive

USB Test Wizard Close

Mode Test
Host HS Disconnect

Step 2 of 4: Probe Hookup

1. Connect a Differential Probe from C1 to D- & D+ of J5 of the 'Disconnect' section of the test fixture. Be sure to match polarity
2. On the HS Electrical Test Tool, Port Control drop down list, select TEST_FORCE_ENABLE then enter the number of the port under test in the port number field. click EXECUTE and observe that operation is successful.
3. Push Next for Disconnect not Detected test.

Reset < Back Next >

LeCroy 11/14/2003 1:01:42 PM

Initial voltage before disconnect (host trace shown above). The same trace applies to hub downstream ports.

The screenshot displays the X-STREAM software interface. At the top, a menu bar includes File, Vertical, Timebase, Trigger, Display, Cursors, Measure, Math, Analysis, Utilities, and Help. A 'C1: Setup...' button is visible on the right. Below the menu is a yellow trace on a black background, with a cursor pointing to a peak. The 'Measure' section shows the following data:

Measure	P1:pkpk(C1)	P2:mean(C3)	P3:time@lv(C2)	P4:max(F2)	P5:max(F3)	P6:---	P7:---	P8:---
value	1.99 V							
mean	1.9860 V							
min	1.94 V							
max	2.06 V							
sdev	25.4 mV							
num	56							
status	✓							

The 'Pass/Fail' section shows the following test results:

Pass/Fail	Q1:True	Q2:	Q3:	Q4:	Q5:	Q6:	Q7:	Q8:
	P1 > 1.25 V	P2 ≈ 3.15 V	P3 < 500 μs	P4 < 0	P5 < 0	P6 < 0	P7 < 0	P8 < 0

The '(Q1) = True' status is highlighted in yellow. Below this, a 'USB Test Wizard' dialog box is open, showing 'Step 4 of 4: EL_36 Disconnect Detected'. The dialog includes a 'Mode' dropdown set to 'Host' and a 'Test' dropdown set to 'HS Disconnect'. The instructions state: '1. The Disconnect Event Detected message should appear in the HS Electrical Test Tool - Status Window box. The SOF pulses should have a peak to peak of more than 1.25V. Pass if Q1 True: P1 > 1.25 V.' and '2. Repeat the test for the other Host ports.' The dialog also features 'Reset', '< Back', and 'Next >' buttons. The bottom of the interface shows the LeCroy logo and the timestamp '11/14/2003 1:02:36 PM'.

Voltage after disconnect (host trace shown above). The same trace applies to hub downstream ports.

HUB HIGH SPEED UPSTREAM REPEATER

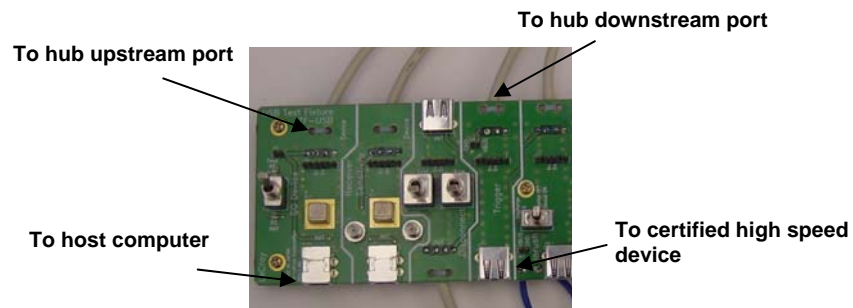

Hub and Device Fixture Connections for Upstream Repeater Test

1. Select **Hub** in the “Mode” control and **HS Upstream Repeater** in the “Test” control of the USB Test Wizard.
2. Connect the host to the INIT port of the “SQ Device” section of the Test Fixture and the upstream facing port of the hub to the test port of the “SQ Device” section of the fixture.
3. Connect a downstream port from the hub to the A cable of the “Trigger” section of the Test Fixture.
4. Connect a certified high-speed device to the INIT connector (J27) of the “Trigger” section of the Test Fixture.
5. Follow the instructions in the USB Test Wizard to acquire the waveforms shown below.

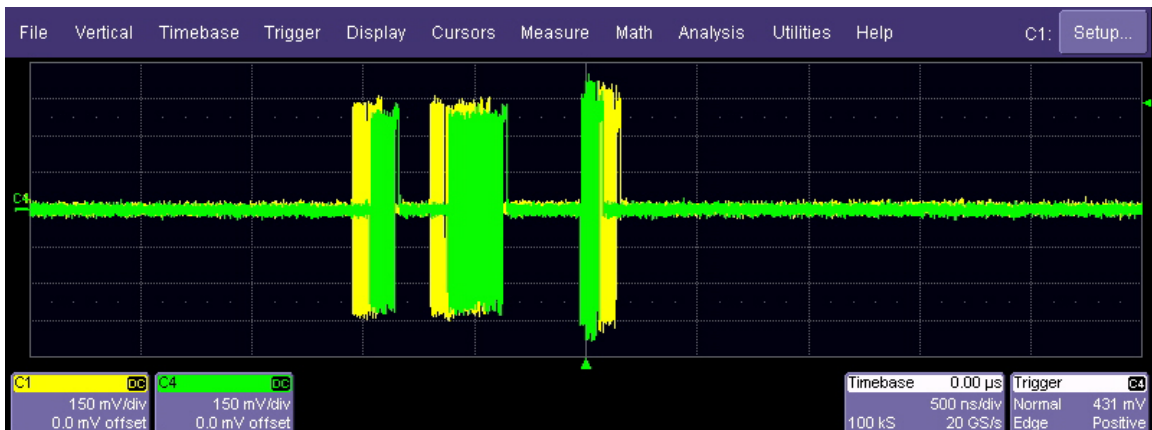

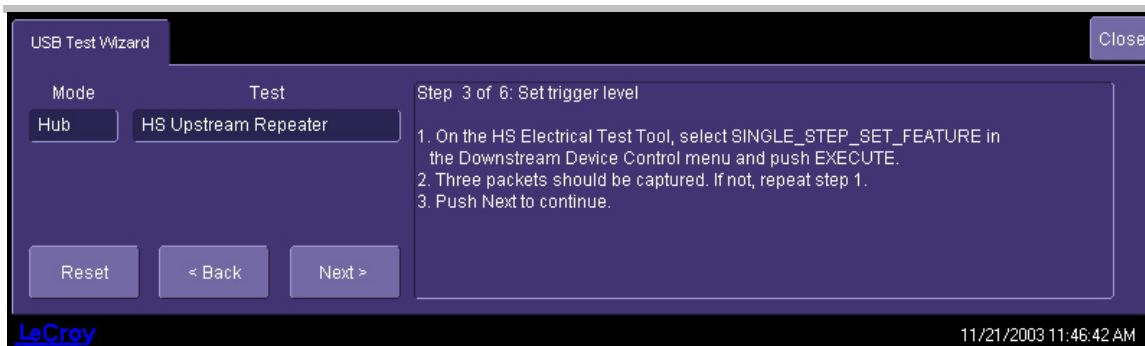

Initial signal acquisition for hub upstream repeater test. The larger pulse is the upstream signal from the hub.

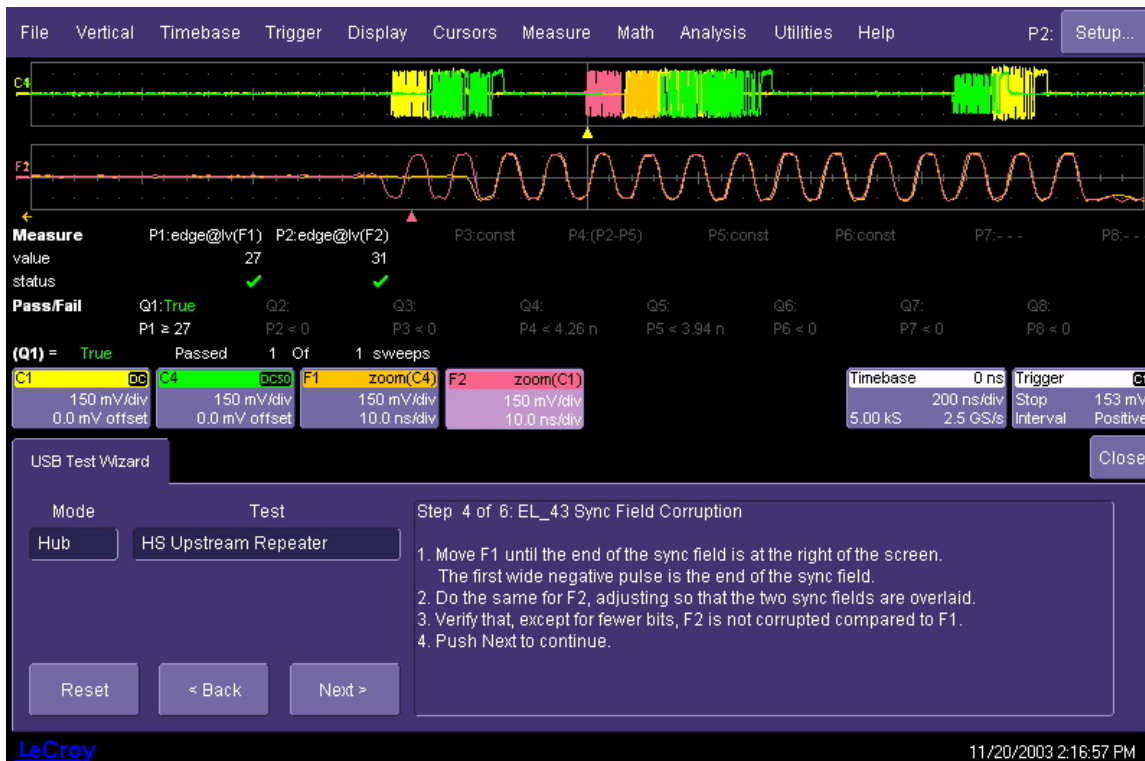

Sync field distortion. The two zoom traces are adjusted using the front panel Zoom controls so that their end of packet pulses (the wide negative pulse on the far right) are overlaid and placed at the very right edge of the display.

USB2 Software Option

The screenshot displays a LeCroy oscilloscope interface with a USB signal trace and a USB Test Wizard dialog box. The trace shows a signal labeled 'C1' with a yellow cursor pointing to a specific point. The interface includes a menu bar (File, Vertical, Timebase, Trigger, Display, Cursors, Measure, Math, Analysis, Utilities, Help) and a 'P2: Setup...' button. Below the trace, there are measurement parameters and a 'Pass/Fail' status table.

Measure	P1: const	P2: max(F1)	P3: max(F2)	P4: (P3*P1)	P5: (P2*P1)	P6: (P4-P5)	P7: - -	P8: - -
value		83.412 ns	87.395 ns	41.950 bit	40.038 bit	1.912 bit		
status		✓	✓	✓	✓	✓		
Pass/Fail	Q1: True	Q2: P6 ≤ 4 bit	Q3: P3 < 0	Q4: P4 < 4.26 n	Q5: P5 < 3.94 n	Q6: P6 < 0	Q7: P7 < 0	Q8: P8 < 0

Additional information shown includes: (Q1) = True, Passed, 1 Of 1 sweeps. The probe is set to C1, DC, 150 mV/div, 19.9 mV offset. The Timebase is 0 ns, 50.0 ns/div, 1.25 kS. The Trigger is C3, Stop, 101 mV, Edge, Positive. The USB Test Wizard is in Step 6 of 6: EL_44, 45 EOP Width comparison. The test mode is Hub, and the test is HS Upstream Repeater. The wizard instructions are: 1. If the end of packet pulses (C1) are not positive, push SINGLE trigger until they are. 2. P5 is the width of the hub input EOP in bits, P4, the width of the output EOP. P6 is the difference. It should be at most 4 bits. Pass if Q1 True: P6 < 4. 3. Verify that the output EOP (C4) is not corrupted. The LeCroy logo and date/time (11/20/2003 2:23:34 PM) are also visible.

The width difference between the input and output EOP is measured using the Width@lvl parameter. This measurement can be affected by DC offset in the differential probe. Autozero the probes prior to performing this test. The test requires a positive EOP; push the "single trigger" button until the displayed trace has a positive-going EOP, as shown in the figure.

HUB HIGH SPEED DOWNSTREAM REPEATER

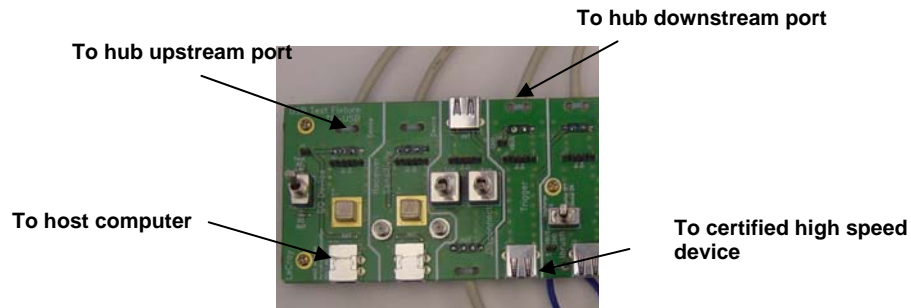

1. Select **Hub** in the “Mode” control and **HS Downstream Repeater** in the “Test” control in the USB Test Wizard.
2. Connect the host to the INIT port of the “SQ Device” section of the Test Fixture, and the upstream facing port of the hub to the test port of the “SQ Device” section of the fixture.
3. Connect a downstream port from the hub to the A cable of the “Trigger” section of the Test Fixture.
4. Connect a certified high-speed device to the INIT connector of the “Trigger” section of the fixture.
5. Follow the instructions in the USB Test Wizard to acquire the waveforms shown below.

File Vertical Timebase Trigger Display Cursors Measure Math Analysis Utilities Help C4: Setup...

Measure

P1: $lv @ x(F1)$	P2: $lv @ x(F1)$	P3: const	P4: (P2-P5)	P5: const	P6: const	P7: - -	P8: - -
value	76.724 ns						
status	✓						

Pass/Fail

Q1: True	Q2: < 0	Q3: < 0	Q4: < 4.26 n	Q5: < 3.94 n	Q6: < 0	Q7: < 0	Q8: < 0
P1 ≤ 79 μ s	P2 < 0	P3 < 0	P4 < 4.26 n	P5 < 3.94 n	P6 < 0	P7 < 0	P8 < 0

(Q1) = True Passed 694 Of 694 sweeps

C1	DC	C4	DC50	F1	track(dt@lv(C...
150 mV/div	150 mV/div	150 mV/div	10.0 ns/div	10.0 ns/div	50.0 ns/div
19.9 mV offset	-100.1 mV ofst		50.0 ns/div		

Timebase	0 ns	Trigger	C3
	50.0 ns/div	Stop	101 mV
10.0 kS	20 GS/s	Edge	Positive

USB Test Wizard Close

Mode: Hub Test: HS Downstream Repeater

Step 3 of 6: EL_48 Hub Repeater Delay

- P1 is the delay between the upstream and downstream SOF packet. It should be less than 79 μ S (36 bits plus 4nS).
Pass if Q1 True: P1 < 79 μ S.
- Push next for sync field comparison.

Reset < Back Next >

LeCroy 11/20/2003 11:24:59 AM

Hub downstream repeater delay: the measured time delay between the input and output sync fields should be less than 36 bits plus 4 ns (< 79 ns). The 4 ns is added to account for the delay through the fixture.

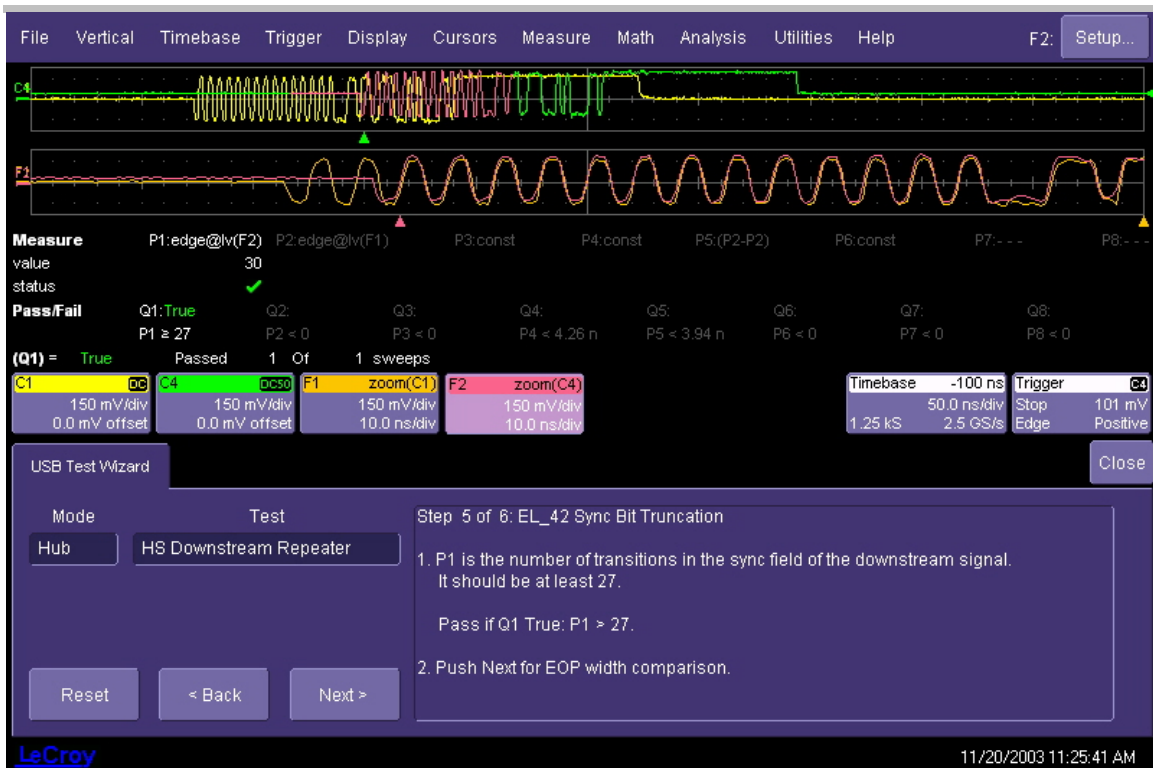

Sync bit truncation. The USB 2.0 specification allows the sync field at the output of a hub to be up to 4 bits shorter than the input.

RECEIVER SENSITIVITY

The receiver sensitivity is measured for devices and the upstream ports of hubs. Receiver sensitivity is measured by applying a signal from a data generator to the input of the device or hub and observing the response of the device or hub. The data generator is set up to transmit IN packets which will be acknowledged by the device or hub. The sensitivity is determined by reducing the level of the signal from the data generator and observing when the DUT no longer responds.

1. Make sure the TEST/INIT switch on the Test Fixture is in the INIT position. Start the USB-IF HS Electrical Test Tool, select **[Device]** and then click **[Test]**.
2. Connect the INIT port of the receiver sensitivity section of the fixture to a high-speed port on the Test Bed Computer. Connect the test port of the receiver sensitivity section of the Test Fixture to the device under test. Click the **[Enumerate Bus]** button once to force enumeration of the newly connected device. The device under test should be enumerated with the device's VID shown together with the root port to which it is connected.
3. Two sets of SMA cables are required, each with a 6 dB attenuator inserted. Connect the 6 dB attenuators to OUTPUT1 and OUTPUT2 of Agilent 81130A Pulse/Pattern Generator. Connect OUTPUT 1 to SMA2, and OUTPUT 2 to SMA1 of the "Device - Receiver Sensitivity" section of the Test Fixture, using the SMA cables.

On the 81130A, select the **[MEMCARD]** softkey. If **[MEMCARD]** is not in the menu, press the **[MORE]** key until **[MEMCARD]** is displayed. The content of the memory will appear on the screen. Use the cursor and the rotary knob to select the **[MIN_ADD1.STO]** setup file. Move the cursor to **[Perform Operation]** and turn the knob to select **[Recall]**. Then press the **[ENTER]** key to load it. This generates "IN" packets (of compliant amplitude) with a 12-bit SYNC field.

- 3a Alternate setup for Tektronix DG2040: Two sets of SMA cables are required, each with a 6 dB attenuator inserted. Connect the 6 dB attenuators to CH1 and CH0 of the DG2040 Data Generator. Connect CH1 to SMA1, and CH2 to SMA2 of the "Device - Receiver Sensitivity" section of the Test Fixture using the SMA cables.

On the DG2040, select the EDIT menu. Then press **[Load Data & Setup]** from the File function. The content of the floppy disk will appear on the screen. Use the jog dial to select the MIN-ADD1.PDA setup file. Press **[OK]** to load it. This generates IN packets (of compliant amplitude) with a 12-bit sync field. Start the data generator with the Start/Stop button.

4. Connect the differential probe from channel 1 of the oscilloscope to J12 of the "Device-Receiver Sensitivity" section of the Test Fixture. Recall the **HSRcvrSensitivity.Iss** panel file on the oscilloscope, using the **File → Recall Setup** menu. Use the **Browse** button in the "Recall Panel From File" control to select the file from the D:\Applications\USB2\Setups directory. Press the **Recall Now** button to select this setup

file.

- From the HS Electrical Test Tool - Device Command menu, select **[TEST_SE0_NAK]** from the Device Command drop down menu. Click **[EXECUTE]** once to place the device into TEST_SE0_NAK test mode.



- Place the Test Fixture Test switch (S1) in the **Test** position. This switches in the data generator in place of the host controller. The data generator emulates the "IN" packets from the host controller.
- Verify that all packets from the data generator are NAKed by the port under test. Adjust the horizontal scale so several packets can be viewed on the oscilloscope display. Record the Pass/Fail in EL_18.
- On the data generator select **[MEMCARD]** softkey. If **[MEMCARD]** is not in the menu, press **[MORE]** key until **[MEMCARD]** is displayed. The content of the memory will appear on the screen. Use the cursor and the rotary knob to select the **IN_ADD1.STO** setup file. Move the cursor to **[Perform Operation]** and turn the knob to select **[Recall]**. Then press the **[ENTER]** key to load it.
- For Tektronix DG2040: On the data generator, select the **Edit** menu, then press **Load Data & Setup** from the File function. The content of the floppy disk will appear on the screen. Use the jog dial to select the **ADD1.PDA** setup file. Press **OK** to load it.
- Verify that all packets are NAKed while signaling is at this amplitude.
- Adjust the output level of each channel as follows:
Select the **[LEVELS]** softkey. If **[LEVELS]** is not in the menu, press **[MORE]** key until **[LEVELS]** is displayed. Then move the cursor to the numeric value for **[High]** voltage value. Adjust the output level with the rotary knob, or by using the number keys while monitoring the actual level on the oscilloscope. Use the cursor arrow buttons to select the channel to change.

Reduce the amplitude of the data generator packets in 20 mV steps (on the generator before the attenuator) while monitoring the NAK response from the device on the oscilloscope. The adjustment should be made to both channels such that OUTPUT1 and OUTPUT2 are matched, as indicated by the data generator readout. Reduce the amplitude until the NAK packet begins to become intermittent. At this point, increase the amplitude such that the NAK packet is not intermittent. This is just above the minimum receiver sensitivity levels before squelch.

- 10a. Tektronix DG2040: Select the **Setup** menu. Then press **High** from the Level Condition function. Adjustment of the output level is best done with the keypad in 50 mV while monitoring the actual level on the oscilloscope. Use the Up and Down arrow buttons to select the channel to change.

Tektronix DG2040: Reduce the signal amplitude in 50 mV steps (before the attenuator) while monitoring the NAK response on the oscilloscope. The adjustment should be made on both channels such that CH0 and CH1 are matched, as indicated by the data generator readout. Reduce the amplitude until the NAK packet begins to become intermittent. At this point, increase the amplitude such that the NAK packet is not intermittent. This is just above the minimum receiver sensitivity level before squelch.

11. Measure the zero-to-positive peak of the packet from the data generator using the cursors in the lower (zoom) window of the oscilloscope display, as shown in the figure below. Use the upper cursor position knob to position cursor 1 on the zero level of the waveform and the lower cursor control knob to position cursor 2 on the positive peak of the waveform. The cursor should be positioned on the plateaus of the wider pulses to avoid inflating the reading due to overshoots. The difference voltage is indicated in the "zoom(C1)" waveform box at the lower left corner of the oscilloscope screen. Record this value in EL_17.

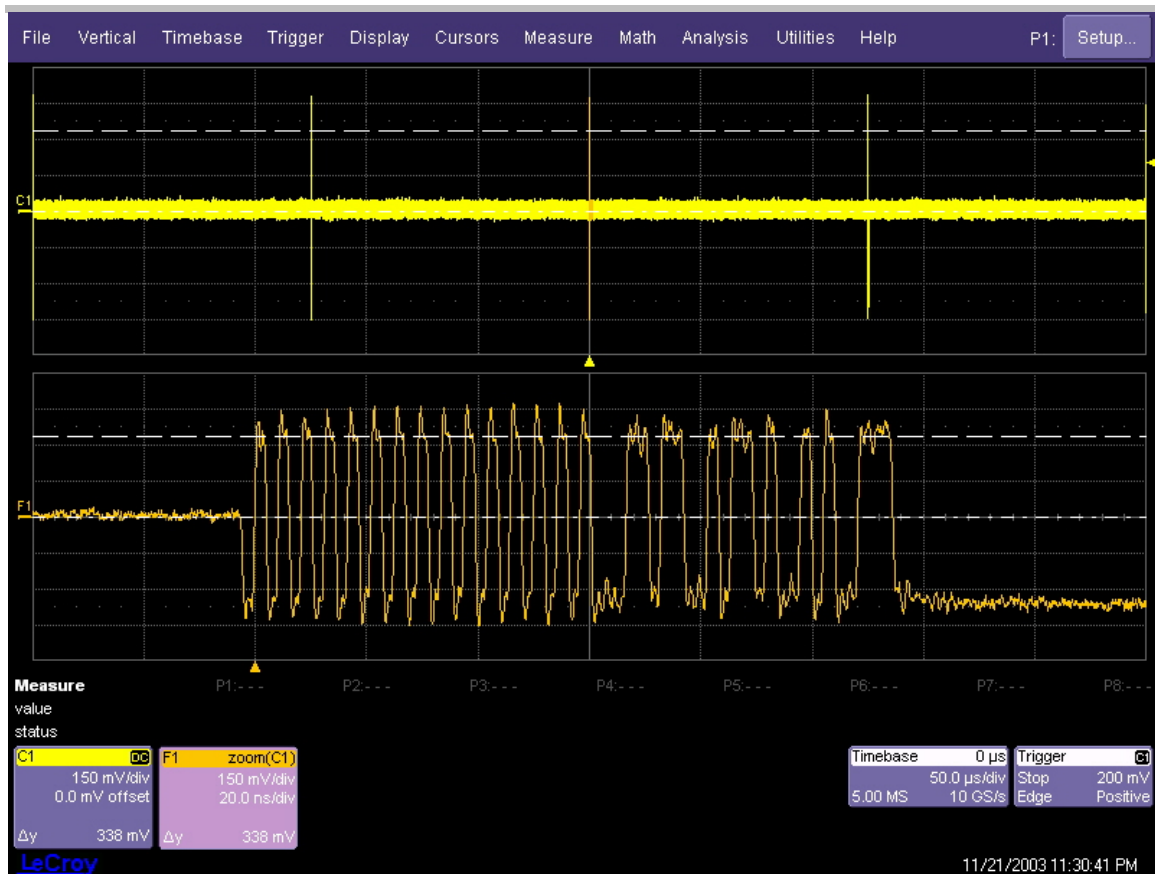

Zero-to-Positive Peak Measurement on Data Generator Packet

12. Move cursor 2 to the negative peak of the waveform in the lower window of the oscilloscope screen, using the lower cursor control knob again, and position the cursor on the wider plateaus to avoid overshoots. Read the difference voltage in the waveform information box at the bottom left of the oscilloscope display. Record this value in EL_17. The receiver must continue to NAK packets above +/- 150 mV to pass the test. Record Pass/Fail in EL_17.

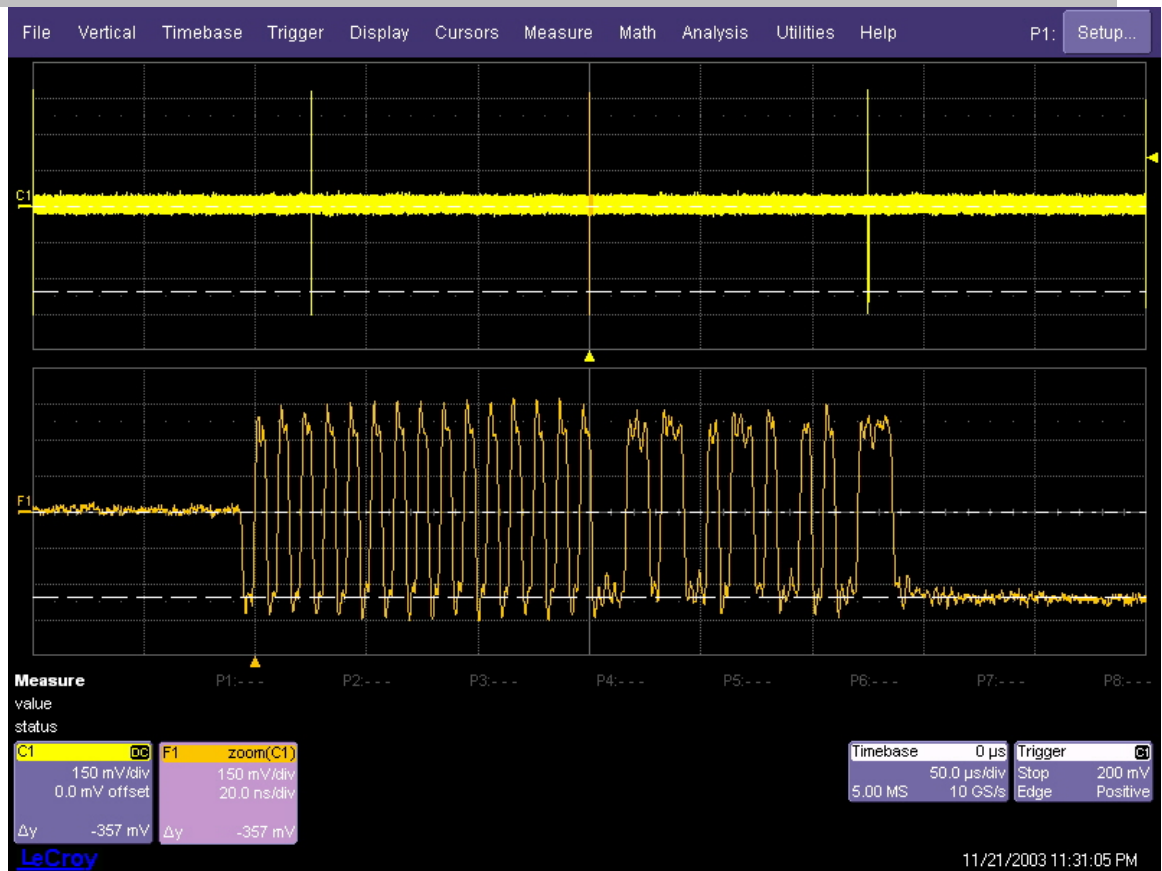

Zero-to-Negative Peak Measurement on Data Generator Packet

13. Now further reduce the amplitude of the packet from the data generator in small steps, still maintaining balance between the outputs until the receiver just ceases to respond with NAK. This is the squelch level of the receiver.
14. Measure the Zero-to-Positive Peak and Negative Peak of the packet from the data generator, using the method described in steps 12 and 13. Record the measurement in EL_16. As long as the receiver ceases to NAK the data generator packet below ± 100 mV, it is considered to have passed the test. Record PASS/FAIL in EL_16.

Note: With certain devices, making an accurate zero-to-peak measurement of the IN packet from the data generator may be difficult due to excessive reflection artifacts. Also, on devices with captive cable, the measured zero-to-peak amplitudes of the IN packet at the test fixture could be considerably higher than that seen by the device receiver. In these situations, it is advisable to make the measurement near the device receiver pins on the PCB.

FULL AND LOW SPEED TESTS

All HS-capable devices, hosts, and hubs must support full (12 Mb/s) speed data rates. Compliance testing requires that this rate be tested, as well as the high-speed (480 Mb/s) rate. Full-speed compliance requires both interoperability and electrical tests. The LeCroy USB 2.0 test solution addresses the electrical test requirements for full-speed operation. These tests include signal quality, inrush current, and droop/drop. The package also supports low-speed electrical tests, which apply only to hub/host downstream ports and low-speed devices. The following sections provide detailed descriptions of the full- and low-speed electrical tests for hosts, hubs and devices.

Equipment requirements

Standard USB products

Refer to the “USB-IF Full and Low Speed Electrical and Interoperability Compliance Test Procedure” available at www.usb.org for a current list of standard USB products recommended for use in FS/LS electrical testing and interoperability testing. Due to limited product lifetimes the approved products for testing change periodically so it is important to obtain the latest equipment lists periodically.

The following list of standard equipment is required for performing low- and full-speed electrical tests:

	Item	Quantity
1	100 mA load board (for bus powered hubs only)	1*
2	500 mA load board	1*
3	Droop test board	1
4	SQiDD board	1
5	Full-speed hub (self powered)	5
6	High-speed hub (self powered)	1
7	5 m USB cables	6

* Additional load boards may be required depending on the number of downstream ports on the product. The test fixture only provides enough loads to test 4 port hubs/hosts.

The first 5 items in the above list are contained within the LeCroy Test Fixture. The figure below shows the sections of the fixture that are used for these tests.

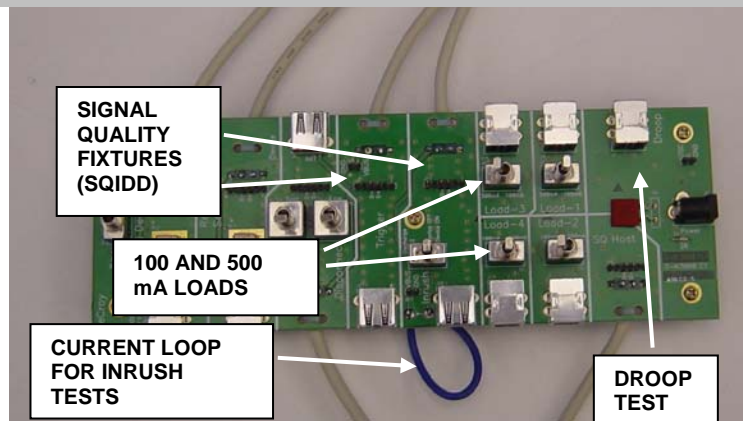

FS/LS Signal Quality Test Fixture Sections

Standard Test Equipment

Item	Description/Model	Qty
Oscilloscope	WaveMaster 8300/8500/8600, SDA6000/5000/3000, WavePro7300/7200, WaveRunner 6200	1
Active probes	HFP2500	2
Active probe	HFP1000	1
Current probe	CP015	1
Multimeter	Keithley 2000 multimeter or equivalent	1
USB host system* (certain LeCroy oscilloscopes can perform this function. See "Installation" section.)	Hardware configuration Intel D865GLC MATX Motherboard, Intel P4 HT CPU 512 MB DDR333, (2) 120 GB UATA/100 HD w/ 8 MB cache, 16x DVD-ROM Drive, 1.44 MB Floppy Drive, IOGEAR GIC250U USB OHCI Host PCI Adapter	1

* Visit www.usb.org for updated equipment recommendations.

Hub and Host Drop Test

NOTE: The drop test is performed using a voltmeter and the test fixture alone. The oscilloscope is not used for this test. The drop test is not contained in the USB Test Wizard.

Set up the voltmeter to measure the voltage drop across the loads, as shown in the figure below. Attach the output ports of the hub or host to the four loads on the Test Fixture. Make sure the three position switches on each load are in the center (off) position.

Note: The Upstream Port ('B' Plug) of the Test Fixture is only required when testing Bus-powered Hubs.

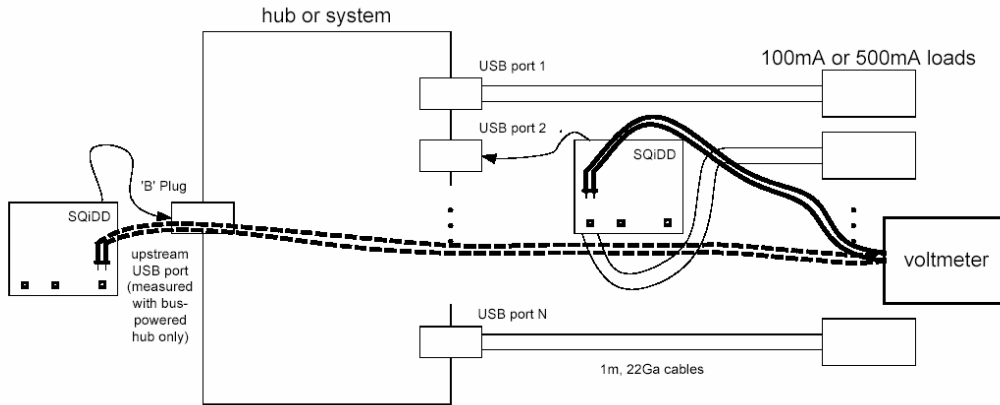

Drop test equipment set up

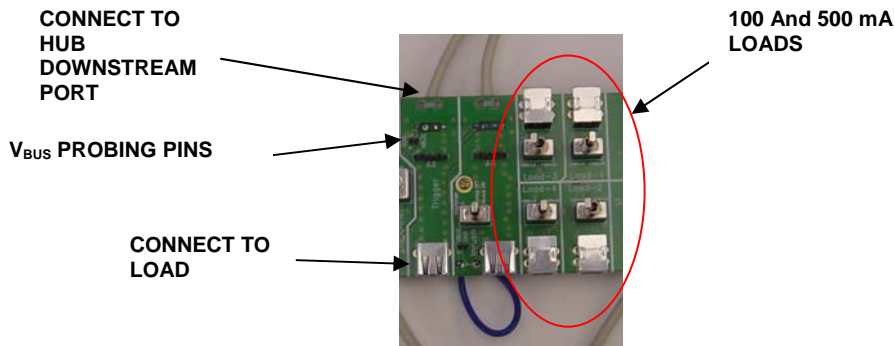

SQiDD Board Connections

Self-powered Hubs or Hosts

1. Switch the loads to the 500 mA position one at a time and verify that the voltage is between 4.75 and 5.25 V.

2. Repeat as necessary for all ports of the hub or host.

$$V_{\text{DROP}} = V_{\text{NL}} - V_{\text{LOADED}}$$

where

$V_{\text{NL}} = V_{\text{BUS}}$ at a downstream USB connector with USB ports open circuited (no load)

and

$V_{\text{LOADED}} = V_{\text{BUS}}$ at a downstream USB connector with 100 or 500 mA loads, as appropriate, on all USB ports

Bus-powered Hubs

1. Switch the loads to the 100 mA position one at a time and verify that the voltage is above 4.4 V.
2. Repeat as necessary for all ports of the hub.

$$V_{\text{DROP}} = V_{\text{UPSTREAM}} - V_{\text{DOWNSTREAM}}$$

where

$V_{\text{UPSTREAM}} = V_{\text{BUS}}$ at a hub's upstream connection

and

$V_{\text{DOWNSTREAM}} = V_{\text{BUS}}$ at one of the hub's downstream ports

Test Criteria

Section 7.2.2 of the USB 2.0 specification requires self-powered downstream USB ports to provide a V_{BUS} between 4.75 and 5.25 V while bus-powered hubs must maintain V_{BUS} at 4.40 V or greater. Drop testing evaluates V_{BUS} under both no-load and full-load (100 or 500 mA, as appropriate) conditions. Self-powered hubs, systems, and laptops must provide a voltage between 4.75 and 5.25 V under all load conditions. Bus-powered hubs must have a $V_{\text{DROP}} \leq 100$ mV between their upstream and downstream ports when 100 mA loads are present on all downstream ports. This ensures that they will supply 4.4 V to a downstream device, given a 4.75 V upstream supply, minus 100 mV drop through the hub and 250 mV drop through the upstream cable. If the hub does not use a captive cable (the USB cable has a B plug), the voltage drop is the difference between the measured upstream voltage level and the lowest measured downstream value. Bus-powered hubs with captive cables (the USB cable does not have a B plug) must have V_{DROP} less than or equal to 350 mV between the upstream connector and their downstream ports; this includes the drop through the cable. Special consideration will be made for laptops that are unable to provide compliant voltages with 500 mA loads while running on battery power, provided they can meet the required voltages with one or more of the loads reduced to 100 mA. However, the end user may experience confusion and difficulty in this situation, unless the operating system or laptop vendor provides a warning message window alerting the user that a high-power device cannot be used under battery power.

Droop test

Equipment setup:

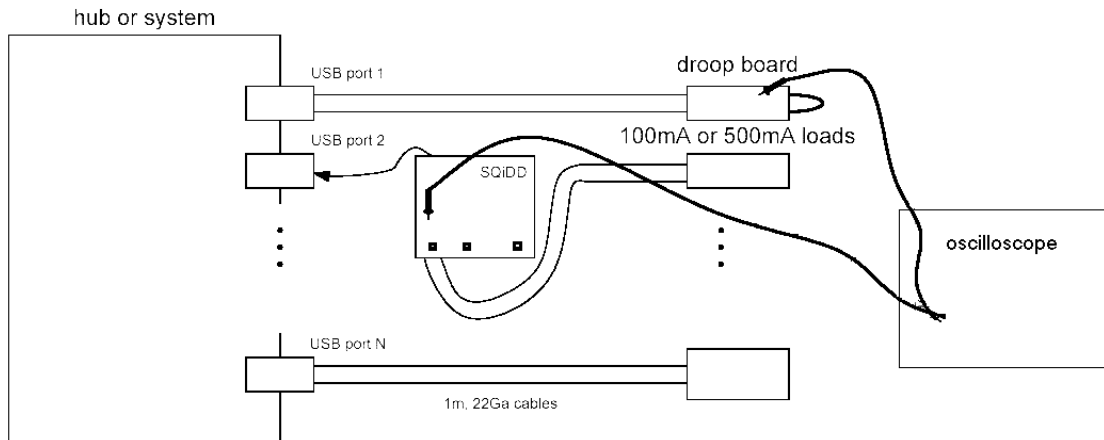

Droop Test Equipment Setup

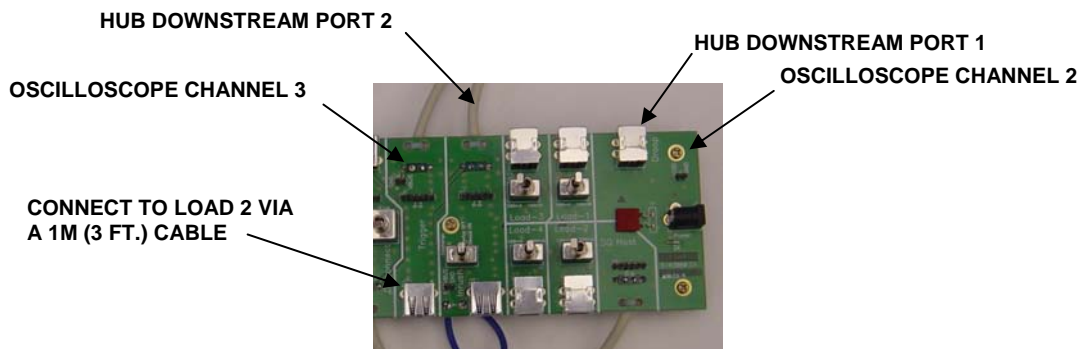

Device and scope connections for droop test. Loads 1, 3, and 4 are connected to the remaining downstream ports

Test Steps

1. Select **Host** or **Hub** in the “Mode” control and **Droop** in the “Test” control of the USB Test Wizard. Follow the instructions in the test wizard to acquire the droop waveform shown below.

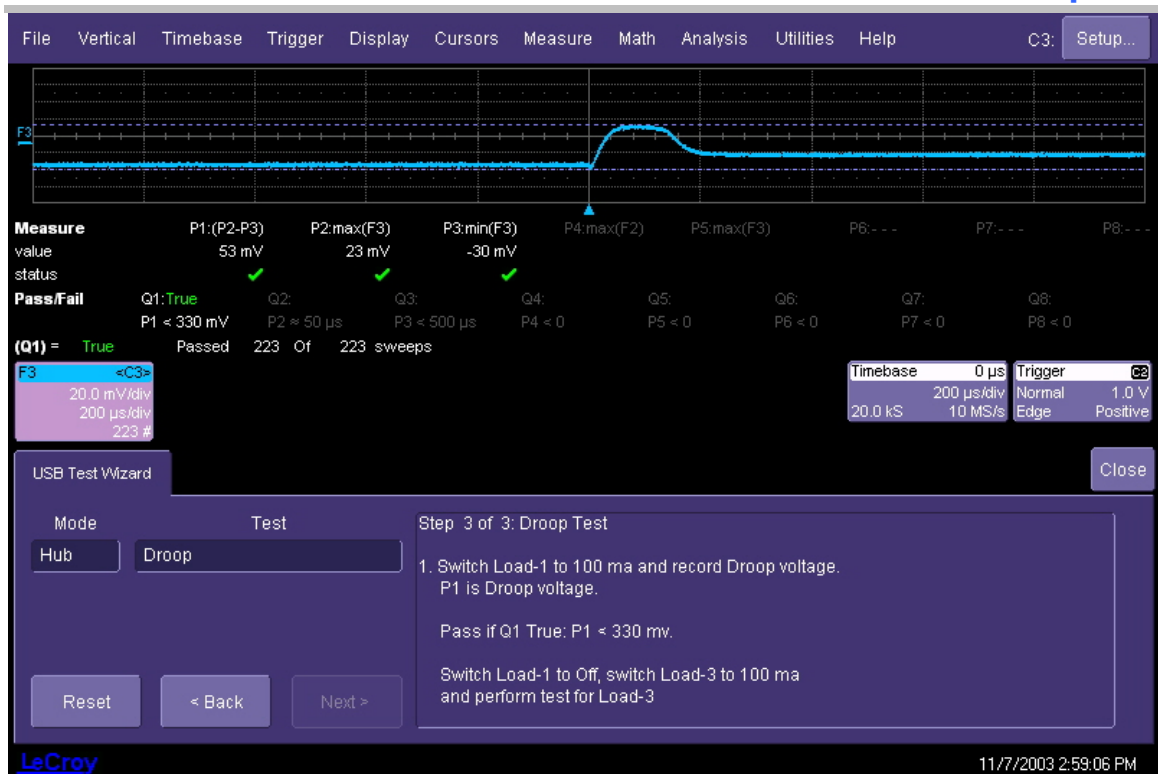

Droop voltage waveform. Note that the waveform indicates a positive voltage pulse even though the droop is in the negative direction

2. Connect port 1 of the hub or host under test to the droop connection (J1) of the Test Fixture (droop event port). Connect port 2 (port under test) of the hub or host under test to the “Trigger” section dangle of the Test Fixture (B cable). Connect J27 of the “Trigger” section to load 2 (J7) of the fixture using a 1 meter (3 ft.) USB cable. Connect the remaining load ports of the Test Fixture to the hub or host under test using 1 meter (3 ft.) USB cables. All hub/host ports should have a load attached. Make sure all of the switches are in the center (OFF) position.
3. Connect channel 2 of the oscilloscope to J3 in the droop section of the fixture. Connect channel 3 of the oscilloscope to J28 in the “Trigger” section of the fixture.
4. Switch all test loads to the appropriate current level as indicated in the table in the “Test Results” section below.

Test Criteria

Section 7.2.4.1 of the USB 1.1 specification allows a maximum droop of 330 mV in the V_{BUS} supplied to a USB port when a device is hot plugged into another port. Droop testing evaluates

worst-case droop by applying a 100 mA load and 10 μ F of capacitance, which switches on and off to one of the adjacent available ports when all other ports are supplying the maximum load possible. All V_{BUS} measurements are relative to local ground.

Test Results

	Bus-powered Hub	Self-powered Hub/System	Laptop	
			Battery powered	Self powered
Load type	100 mA	500 mA	__100__ 500 mA	500 mA
V_{NL}				
V_{LOADED}				
$V_{UPSTREAM}$				
$V_{DOWNSTREAM}$				
V_{DROP}				
V_{DROOP}	Less than 330 mV			

Reporting Results

No Load Voltage: passing values are from 4.75 to 5.25 V

Loaded Voltage: passing values are from 4.75 to 5.25 V

Upstream Voltage: passing values are from 4.40 to 5.25 V

Downstream Voltage: passing values are from 4.75 to 5.25 V

Voltage Drop:

Droop Voltage:

Host Low Speed Downstream Signal Quality

1. Set up the equipment as shown in the following figure.
2. Select **Host** in the “Mode” control and **LS Downstream Signal Quality** in the “Test” control of the USB Test Wizard.
3. Use the “Inrush” or “SQ Device” section of the Test Fixture as the SQiDD in the figure below. Make sure that the TEST/INIT switch is in the INIT position and the switch in the Inrush section is in the ON position. The best method to capture and analyze low-speed downstream signal quality is to capture both a keep-alive (low-speed EOP) and a packet.

USB2 Software Option

The root hub is required to either generate a keep-alive or send low-speed traffic once per frame whenever a low-speed device is directly attached. To capture downstream traffic with low-speed devices, a trigger on the rising edge of D- is used.

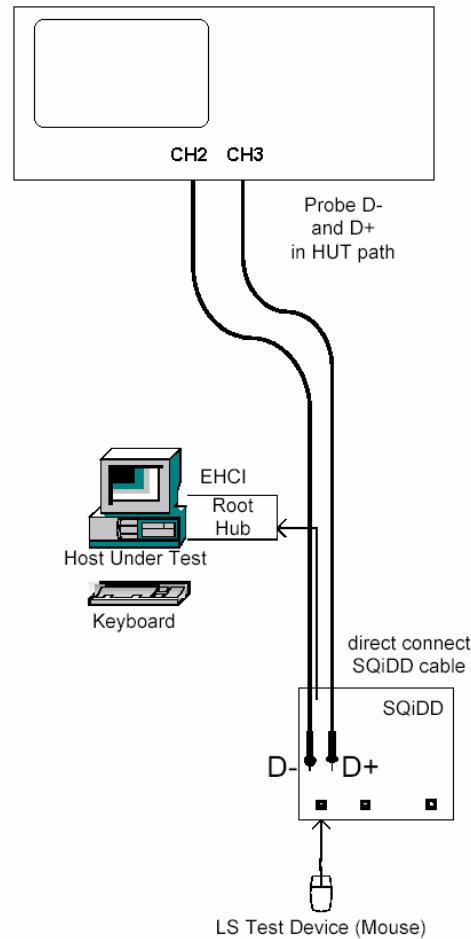

Host Low Speed Downstream Signal Quality Test Equipment Setup

Note: The USB-IF high-speed electrical test tool is not used for this test and should not be running

4. Press the single acquisition button on the oscilloscope until a full packet is displayed on the screen. The full packet may consist of the "keep alive" and a data packet, or could be just a data packet and should fill most of the scope screen. Use the cursors to select the

downstream portion of the data packet as shown in the figure below. The cursors are set to 1 UI before the first bit in the sync field on the left and 1 UI after the end of the EOP on the right.

5. Press the **Next** button in the USB Test Wizard once the proper packet is captured. The MATLAB analysis script will be executed and the signal quality eye pattern will be displayed.

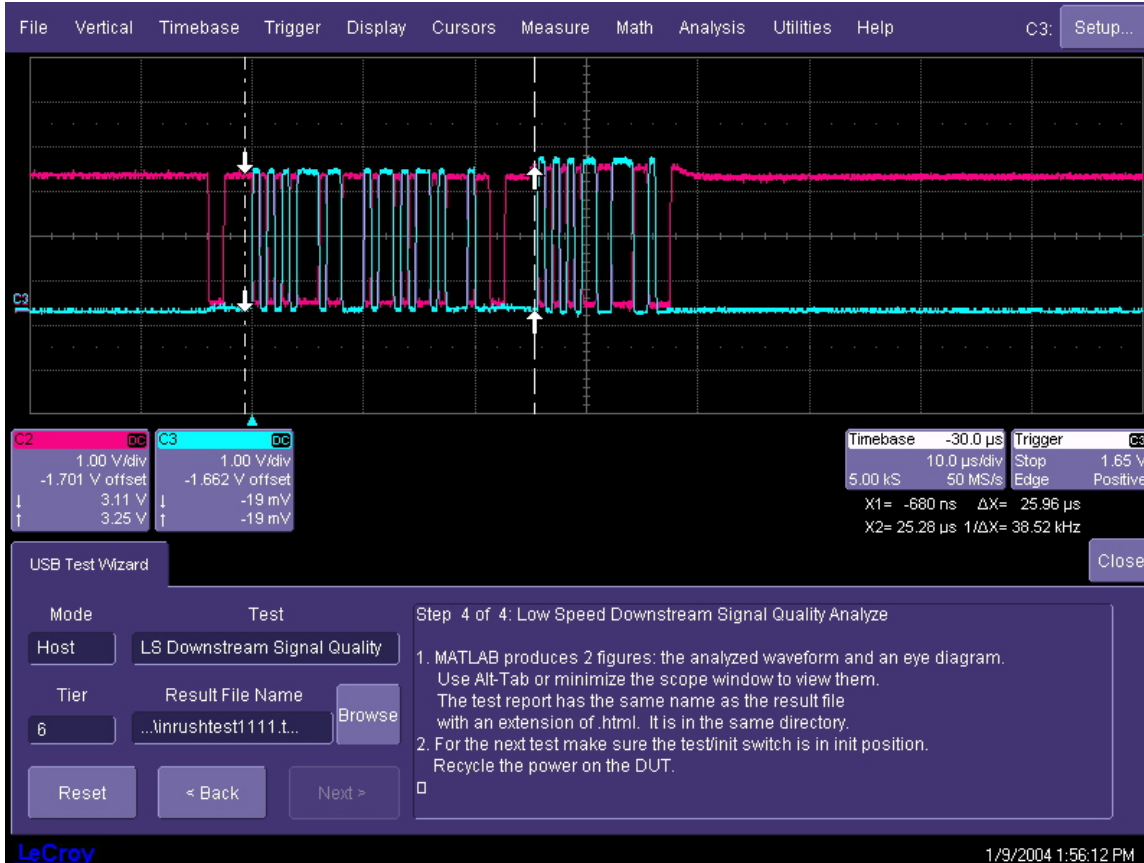

Cursor Positioning for Host Low Speed Signal Quality Test

Host Full Speed Downstream Signal Quality

1. Connect the system as shown in the figure below.
2. Select **Host** and **FS Downstream Signal Quality** in the USB Test Wizard on the scope.
3. Plug a full-speed device into hub number 5 and verify that it enumerates. If the device fails to enumerate, this could be due to low receiver sensitivity. Remove hub 5 and hub 4

USB2 Software Option

and repeat the enumeration. The tier control in the USB Test Wizard should be set to 6 when all hubs in the chain are being used. This number must be reduced by the number of hubs that must be removed to achieve enumeration.

Note: The USB-IF high-speed electrical test tool is not used for this test and should not be running

4. Follow the steps in the USB Test Wizard on the instrument display to capture the appropriate waveform. It may be necessary to repeat the acquisition in order to capture a full screen of data. Use the cursors to select the downstream portion of the data packet, as shown in the figure below. The cursors are set to 1 UI before the first bit in the sync field on the left and 1 UI after the end of the EOP on the right. The software will generate an HTML report on the signal quality.

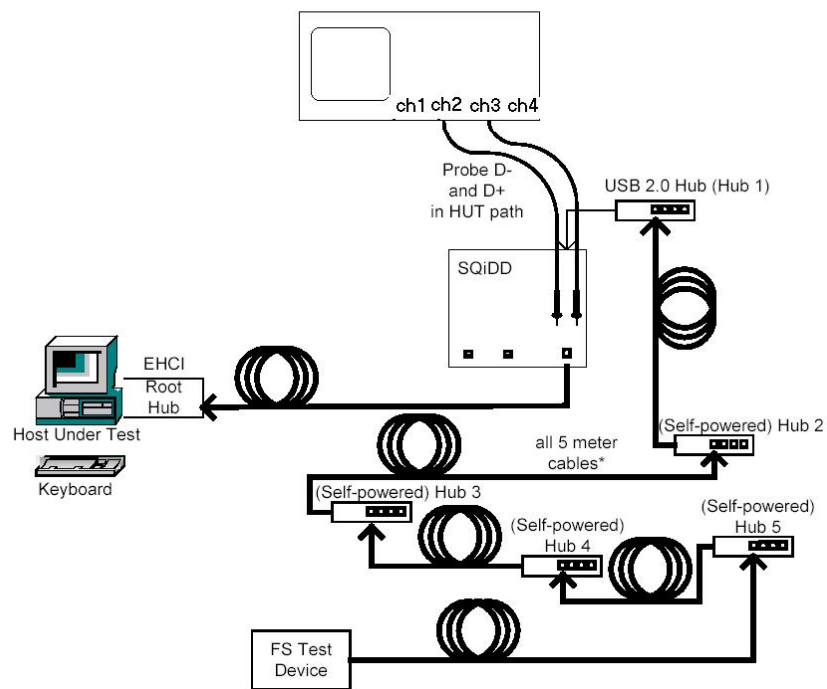

Host Full Speed Downstream Signal Quality Test Equipment Setup

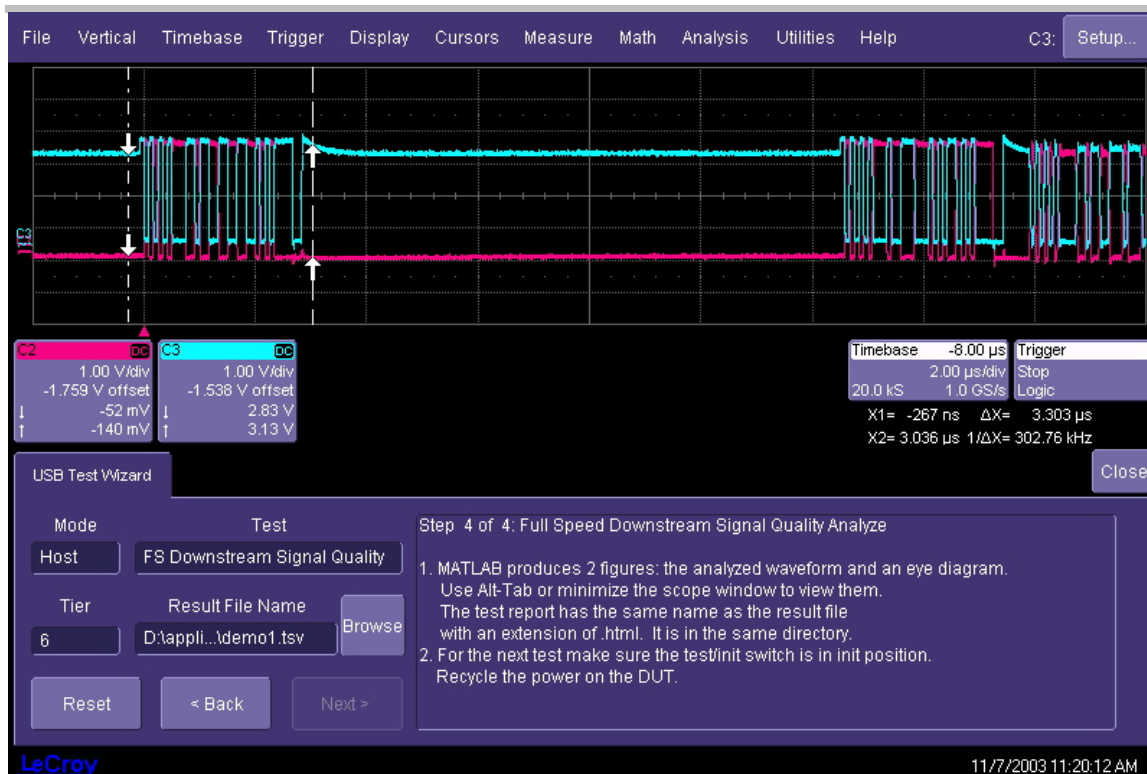

Cursor Positioning For Host Full Speed Downstream Signal Quality

Inrush current

Inrush current is generated by devices when they are connected to a hub or host. Self-powered devices should have negligible inrush current so this test will normally not indicate any inrush current for this type of device. Inrush is measured using the “Inrush” section of the test fixture.

The arrow on the current probe must point in the same direction as the arrow on the Test Fixture. The current probe (LeCroy CP015 or equivalent) is attached to channel 4 of the oscilloscope. The oscilloscope is set to trigger on the rising edge of the current pulse measured on channel 4. In order to avoid problems associated with switch bounce, the inrush measurement is initiated by plugging the device under test into the Inrush section of the Test Fixture. The sequence of operations is

1. Move the switch in the “Inrush” section from the **[ON]** position to the **[Discharge]** position.
2. Unplug the device under test.

USB2 Software Option

3. Move the switch back to the [ON] position; the scope may trigger and capture a waveform
4. Plug the device under test into the “Inrush” port; the scope will trigger again and capture a current waveform as shown below:



P1 Gate Cursor Positioning around Inrush Current Pulse

5. If the waveform’s vertical amplitude is too small or too large (off the screen), adjust the vertical scale of channel 4 and repeat steps 1 through 4 above. The inrush current should be a continuous curve similar to the one shown above. Repeat steps 1 through 4 above until a good current trace is captured.

The inrush current must include only the current associated with the initial device plug-in event and not the steady state current. Parameter gate cursors are used for this purpose. If the cursors do not appear on the screen (dashed lines), touch the “P1” readout at the

bottom of the oscilloscope grid or click this area with a mouse. The cursors are adjusted using the “cursor” knobs on the oscilloscope’s front panel.

The inrush test integrates the current trace to obtain a total charge, and the USB specification requires that the total charge be less than 50 μC .

6. Place the cursors around the main current pulse, as shown above. It is important to avoid including too much of the steady state current (to the right of the pulse). In some cases, the device may have some smaller pulses after the main inrush pulse. In this case, pulses farther than 50 ms after the main current pulse should not be included in the measurement. The measurement, along with an image of the current trace are saved as part of the test record.

Hub Down Stream Low Speed Signal Quality

1. Set up the equipment as shown below. The hub is tested at tier 5 (at the end of a chain of four hubs). The first hub in the chain must be a USB 2.0 hub. The chain of hubs is intended to test the receiver sensitivity of the hub.
2. Start the USB High Speed Test Tool, select **[Device]** and then press **[Test]**. Press **[Enumerate Bus]** and verify that the hub under test appears in the “Select Device” window.
3. A low-speed device (mouse) is connected between a downstream port of the hub under test through the “Inrush” section of the Test Fixture. Make sure the Inrush switch is in the **[ON]** position.
4. Select **Hub** in the mode control and **LS Downstream Signal Quality** in the test control of the USB Test Wizard. The trigger will be set up to acquire a waveform on the scope on the rising edge of the D- line in Single trigger mode.
5. Press the **SINGLE** trigger button on the scope until a full packet is captured on the screen. Use the cursors to select the downstream portion of the data packet as shown in the figure below. The cursors are set to 1 UI before the first bit in the sync field on the left and 1 UI after the end of the EOP on the right.
6. Press **Next** in the USB Test Wizard to process the waveform. MATLAB will generate an eye pattern and waveform file and an HTML signal quality report. These files will be stored in the D:\Applications\USB2\Results directory.

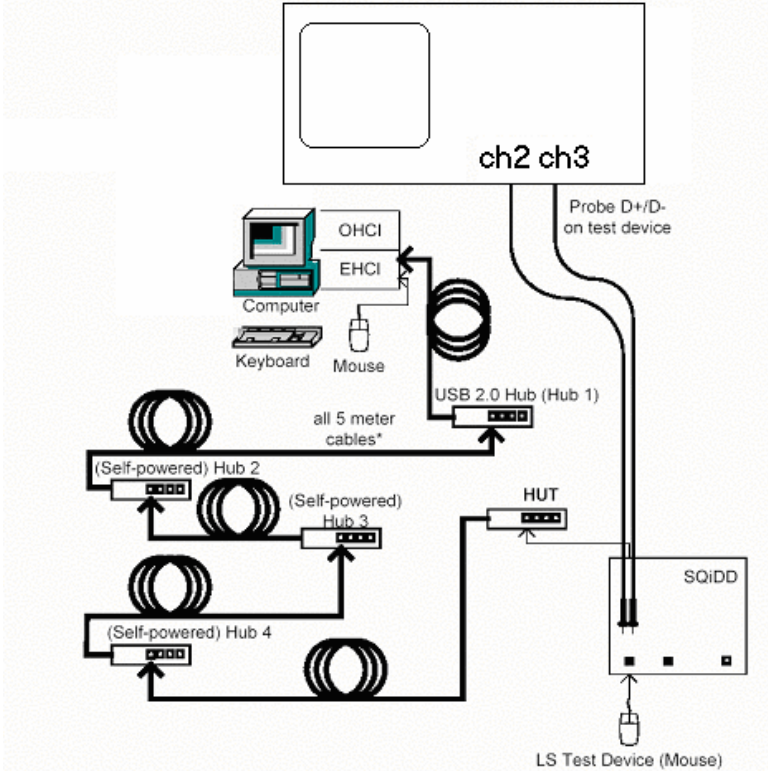

TO HUB
UNDER TEST



TO TEST DEVICE
(MOUSE)

Hub Low Speed Downstream Signal Quality Setup

Hub Full Speed Downstream Signal Quality

1. Set up the equipment as shown below. The hub is tested at tier 5 (at the end of a chain of 4 FS hubs). The first hub in the chain is a USB 2.0 hub. The chain of hubs is intended to test the receiver sensitivity of the hub.

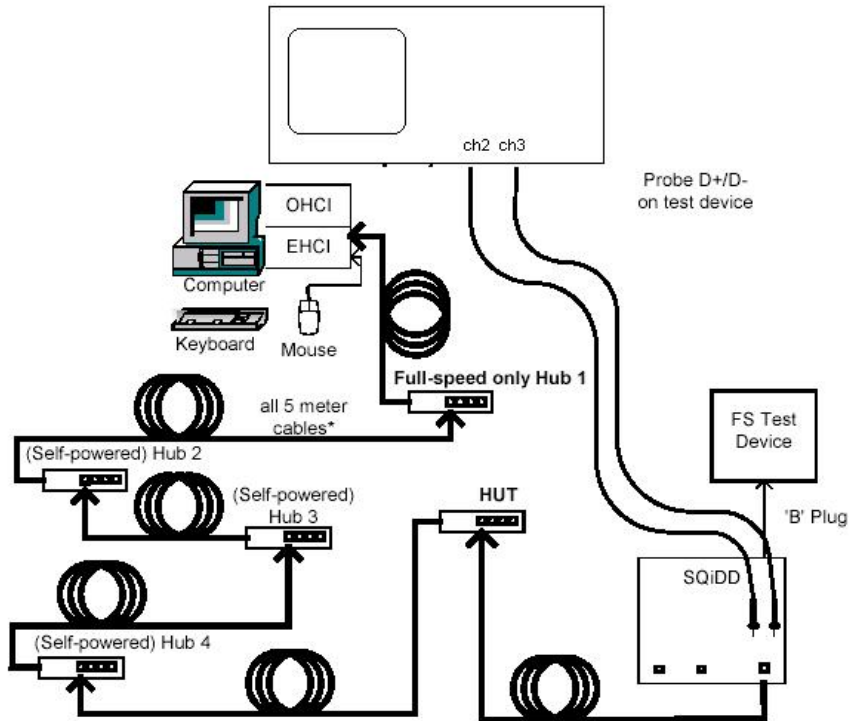

Hub Full Speed Downstream Signal Quality Test Setup

2. Start the USB High Speed Test Tool, select **[Device]** and then press **[Test]**.
3. Press **[enumerate bus]** and verify that the hub under test appears in the "Select Device" window.
4. A full-speed device is connected to the downstream port of the hub under test through the "Inrush" section of the Test Fixture. Make sure the Inrush switch is in the **[ON]** position.
5. Select **Hub** in the mode control and **FS Downstream Signal Quality** in the test control of the USB Test Wizard. The trigger will be set up to acquire a waveform on the scope on the rising edge of the D+ line in the single trigger mode.

6. Press the **SINGLE** trigger front panel button on the scope until a full packet is captured on the screen. Use the cursors to select the downstream portion of the data packet, as shown in the figure below. The cursors are set to 1 UI before the first bit in the sync field on the left and 1 UI after the end of the EOP on the right.
7. Press **Next** in the USB Test Wizard to process the waveform. MATLAB will generate an eye pattern and waveform file and an HTML signal quality report. These files will be stored in the D:\Applications\USB2\Results directory.

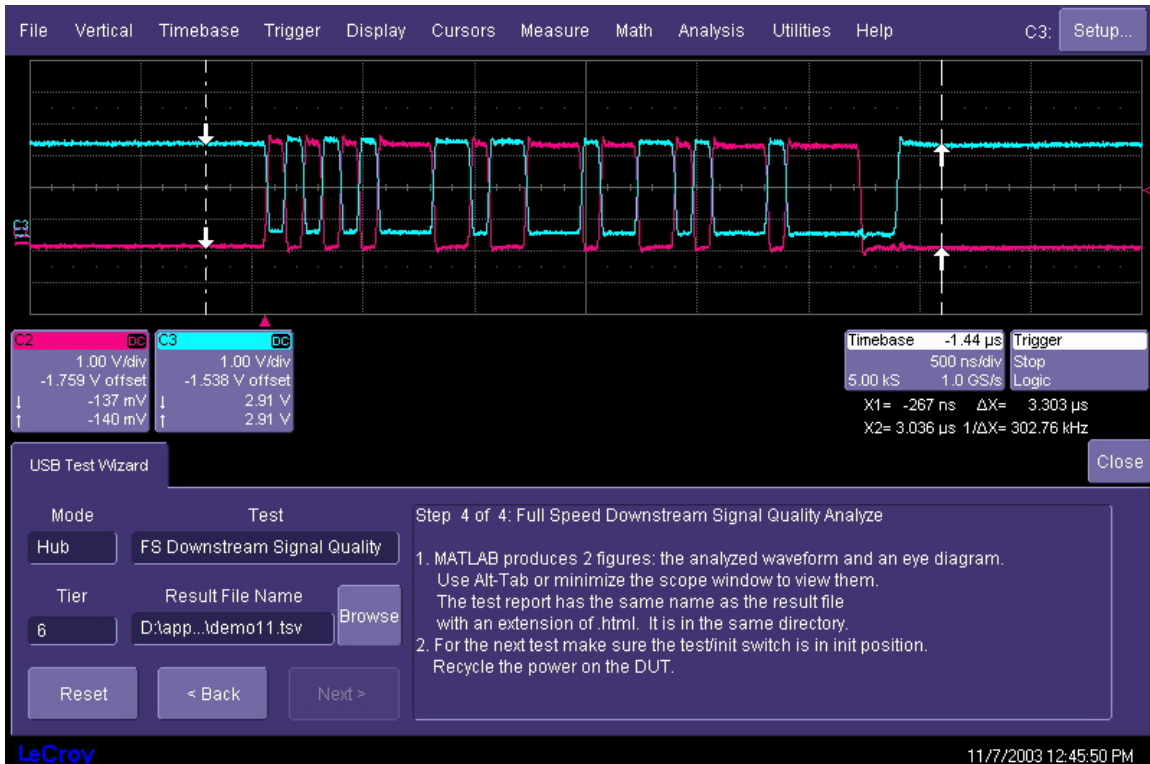

Cursor Placement For Hub Downstream Signal Quality Test

Device and Hub Full Speed Upstream Signal Quality Test

Upstream signal quality is tested for both hubs and devices and at both full and low speeds. USB 2.0 devices require only the full-speed mode to be tested. The setup below is used in all cases. The device or hub under test is connected to the last hub in the chain through the "Inrush" section of the Test Fixture. A second device is connected to the hub through the "Trigger" section of the Test Fixture. The second device must be a low-speed device for low-speed testing or a full-speed

device for full-speed testing. The chain of hubs is intended to test the receiver sensitivity of the hub or device.

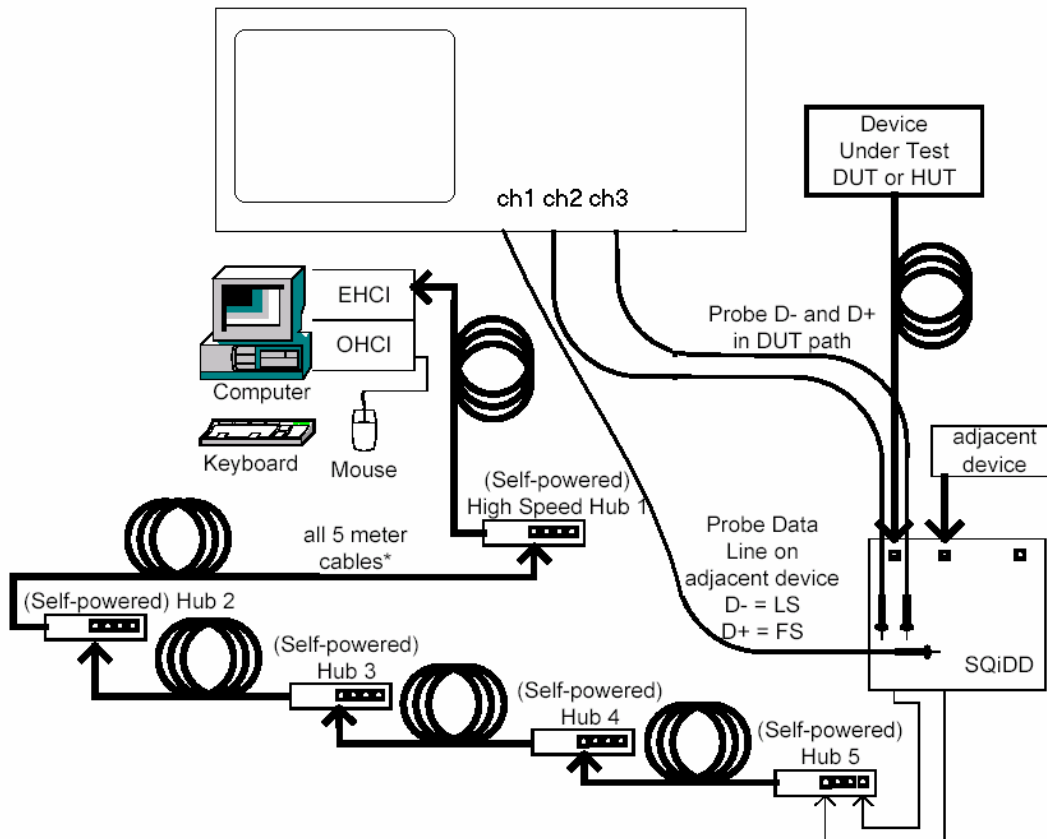

Upstream Signal Quality Test Equipment Setup

1. Start the USB High Speed Test Tool, select **[Device]** and then press **[Test]**.
2. Press **[enumerate bus]** and verify that the hub or device under test appears in the "Select Device" window. If the hub or device under test fails to enumerate, remove full speed hubs one at a time from the end of the chain until it does. The number of hubs between the host and the device under test plus one is the tier at which the enumeration takes place.
3. Select the device or hub under test from the list in the "Select Device" window of the USB High Speed Test Tool and select **[loop device descriptor]** in the "Device Command" control.

- In the USB Test Wizard, select the appropriate mode (**Hub** or **Device**) and the appropriate test (**FS** or **LS Upstream Signal Quality**). The trigger will be set to the D+ pin in the "Trigger" section for testing full-speed devices or to the D- pin for low-speed devices. The trigger mode will be set to single.
- Press the **SINGLE** trigger front panel button until a complete packet is captured. The waveform will consist of both downstream and upstream data. The upstream portion corresponds to the part of the differential signal (channels 2 and 3) after the last bit in the trigger channel (channel 1). Use the cursors to select the downstream portion of the data packet, as shown in the figure below. The cursors are set to 1 UI before the first bit in the sync field on the left and 1 UI after the end of the EOP on the right.

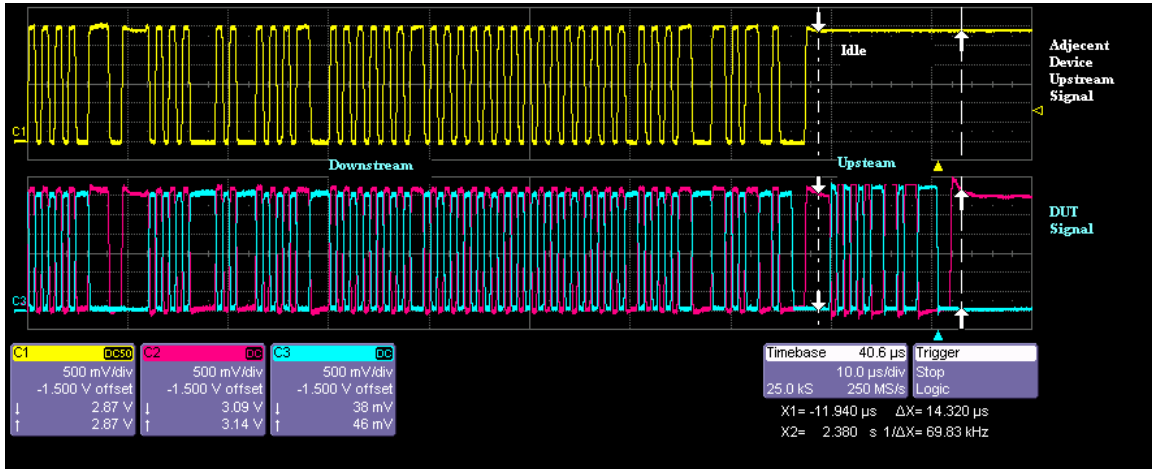

Isolation of Upstream Data Packet

- Press **Next** in the USB Test Wizard to process the waveform. MATLAB will generate an eye pattern and waveform file and an HTML signal quality report. These files will be stored in the D:\Applications\USB2\Results directory.

§ § §