

AVO100C-48S3V3

100 Watts

Eighth-brick Converter

Total Power: 100 Watts
Input Voltage: 36 to 75 Vdc
of Outputs: Single

Special Features

- Delivering up to 30A output current
- Ultra-high efficiency 92.4% typ. at full load
- Wide input range: 36V ~ 75V
- Excellent thermal performance
- No minimum load requirement
- Pre-bias function
- ROHS 6 compliant
- Remote control function
- Remote output sense
- Trim function: 80% ~ 110%
- Input under voltage lockout
- Output over current protection
- Output short protection
- Output over voltage protection
- Over temperature protection
- Industry standard eighth-brick pin-out outline
- Standard module with baseplate
- Pin length option: 4.8mm, 3.8mm

Safety

IEC/EN/UL/CSA 60950
CE Mark
UL/TUV
EN55022 Class A

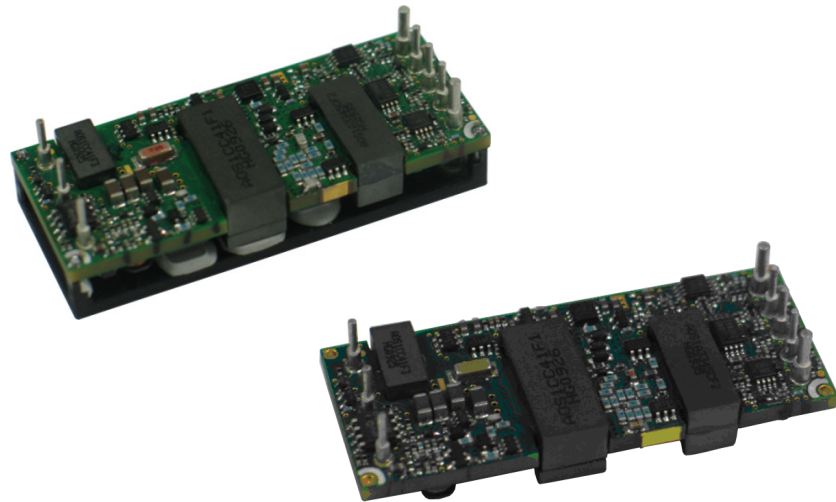

Product Descriptions

The AVO100C-48S3V3 is a single output DC/DC converter with standard eighth-brick form factor and pin configuration. It delivers up to 30A output current with 3.3V output. Ultra-high 92.4% efficiency and excellent thermal performance makes it an ideal choice for use in small space, telecom and datacom applications and can operate over an ambient temperature range of -40 °C ~ +85 °C.

Applications

Telecom/ Datacom

Model Numbers

Standard	Output Voltage	Structure	Remote ON/OFF logic	RoHS Status
AVO100C-48S3V3	3.3Vdc	Open-frame	Negative	R6
AVO100C-48S3V3P	3.3Vdc	Open-frame	Positive	R6
AVO100C-48S3V3B	3.3Vdc	Baseplate	Negative	R6
AVO100C-48S3V3PB	3.3Vdc	Baseplate	Positive	R6

Ordering information

AVO100C	-	48	S	3V3	P	B	-	4	L
①		②	③	④	⑤	⑥		⑦	⑧

①	Model series	AVO: series name, 100: output power 100W, C: Version
②	Input voltage	48: 36V ~ 75V input range, rated input voltage 48V
③	Output number	S: single output
④	Rated output voltage	3V3: 3.3V output
⑤	Remote ON/OFF logic	Default: negative logic; P: positive logic
⑥	Baseplate	B: with baseplate; default: without the baseplate
⑦	Pin length	4: 4.8mm
⑧	RoHS status	L: Rohs, R6; Y: RoHS, R5

Options

None

Electrical Specifications

Absolute Maximum Ratings

Stress in excess of those listed in the “Absolute Maximum Ratings” may cause permanent damage to the power supply. These are stress ratings only and functional operation of the unit is not implied at these or any other conditions above those given in the operational sections of this TRN. Exposure to any absolute maximum rated condition for extended periods may adversely affect the power supply’s reliability.

Table 1. Absolute Maximum Ratings:

Parameter	Model	Symbol	Min	Typ	Max	Unit
Input Voltage Operating -Continuous Non-operating -100mS	All	$V_{IN,DC}$	-	-	80	Vdc
	All		-	-	100	Vdc
Maximum Output Power	All	$P_{O,max}$	-	-	200	W
Ambient Operating Temperature	All	T_A	-40	-	+85	°C
Isolation Voltage ¹ Input to outputs Input to baseplate Output to baseplate	Open frame module		2000	-	-	Vdc
	Baseplate module		1500	-	-	Vdc
	Baseplate module		500	-	-	Vdc
Storage Temperature	All	T_{STG}	-55	-	+125	°C
Voltage at remote ON/OFF pin	All		-0.7	-	12	Vdc
Humidity (non-condensing) Operating Non-operating	All		-	-	95	%
	All		-	-	95	%

Note 1 - 1mA for 60s, slew rate of 2000V/10s.

Input Specifications

Table 2. Input Specifications:

Parameter	Conditions	Symbol	Min	Typ	Max	Unit
Operating Input Voltage, DC	All	$V_{IN,DC}$	36	48	75	Vdc
Turn-on Voltage Threshold	$I_O = I_{O,max}$	$V_{IN,ON}$	31	-	36	Vdc
Turn-off Voltage Threshold	$I_O = I_{O,max}$	$V_{IN,OFF}$	30	-	35	Vdc
Lockout Voltage Hysteresis	$I_O = I_{O,max}$		1	-	3	V
Maximum Input Current ($I_O = I_{O,max}$)	$V_{IN,DC} = 36V_{DC}$	$I_{IN,max}$	-	-	3.5	A
No-load Input Current			-	0.05	-	A
Standby Input Current			-	0	0.1	A
Inrush Current Transient Rating			-	-	1	A ² s
Recommended Input Fuse	Fast blow external fuse recommended		-	-	10	A
Recommended External Input Capacitance	Low ESR capacitor recommended	C_{IN}	100	-	-	uF
Input Reflected Ripple Current	Through 12uH inductor		-	20	-	mA
Operating Efficiency	$T_A = 25\text{ }^{\circ}\text{C}$ $I_O = I_{O,max}$ $I_O = 50\%I_{O,max}$ $I_O = 20\%I_{O,max}$	η	-	92.4 93.1 89.5	-	% % %

Output Specifications

Table 3. Output Specifications:

Parameter	Condition	Symbol	Min	Typ	Max	Unit	
Factory Set Voltage	$V_{IN,DC} = 48V_{DC}$ $I_O = I_{O,max}$	V_O	3.25	3.3	3.35	Vdc	
Total Regulation	Inclusive of line, load temperature change, warm-up drift	V_O	3.184	3.3	3.416	Vdc	
Output Voltage Line Regulation	All	$\%V_O$	-	3.3	-	mV	
Output Voltage Load Regulation	All	$\%V_O$	-	3.3	-	mV	
Output Voltage Temperature Regulation	All	$\%V_O$	-	-	0.02	$\%/^{\circ}C$	
Output Voltage Trim Range	All	V_O	2.64	-	3.63	V	
Output Ripple, pk-pk	Measure with a 1uF ceramic capacitor in parallel with a 10uF tantalum capacitor, 0 to 20MHz bandwidth	V_O	-	50	-	mV_{PK-PK}	
Output Current	All	I_O	0	-	30	A	
Output DC current-limit inception ¹		I_O	32	-	45	A	
V_O Load Capacitance ²	All	C_O	330	-	10000	μF	
Vout pre-bias level			-	-	90	$\%V_O$	
V_O Dynamic Response	Peak Deviation Settling Time	25% ~ 50% ~ 25% $I_{O,max}$ load change slew rate = 0.1A/us	$\pm V_O$	-	50	-	mV
		T_s	-	100	-	μSec	
		25% ~ 50% ~ 25% $I_{O,max}$ load change slew rate = 1A/us	$\pm V_O$	-	200	-	mV
			T_s	-	30	-	μSec
Turn-on transient	Rise time	$I_O = I_{max}$	T_{rise}	-	15	-	mS
	Turn-on delay time	$I_O = I_{max}$	$T_{turn-on}$	-	50	-	mS
	Output voltage overshoot	$I_O = 0$	$\%V_O$	-	0	-	%
Switching frequency	All	f_{sw}	-	165	-	KHz	
Remote ON/OFF control (positive logic)	Off-state voltage	All	-0.7	-	1.2	V	
	On-state voltage	All	3.5	-	12	V	

Note 1 - Hiccup: auto-restart when over-current condition is removed.

Note 2 - High frequency and low ESR is recommended.

Output Specifications

Table 3. Output Specifications, con't:

Parameter		Condition	Symbol	Min	Typ	Max	Unit
Remote ON/OFF control (Negative logic)	Off-state voltage	All		3.5	-	12	V
	On-state voltage	All		-0.7	-	1.2	V
Output over-voltage protection ³		All	V _O	3.8	-	5	V
Output over-temperature protection ⁴		All	T	111	120	128	°C
With baseplate				119	126	135	°C
Over-temperature hysteresis		All	T	5	-	-	°C
MTBF		Telcordia SR-332-2006; 80% load, 300LFM, 40 °C T _A		-	1.5	-	10 ⁶ h

Note 3 - Hiccup: auto-restart when over-voltage condition is removed.

Note 4 - Auto recovery.

AVO100C-48S3V3-6L Performance Curves

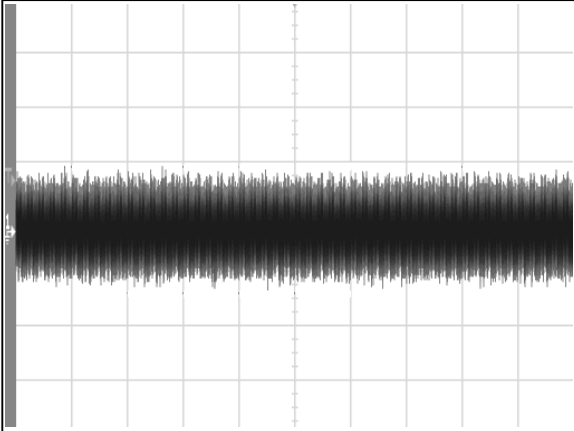

Figure 1: AVO100C-48S3V3 Input Reflected Ripple Current Waveform
Ch 1: lin (100mS/div, 10mA/div)

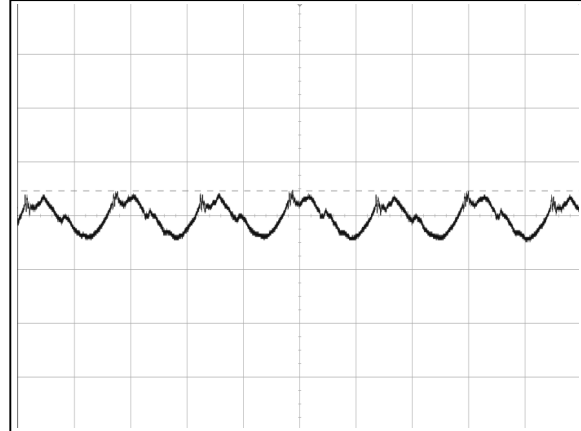

Figure 2: AVO100C-48S3V3 Ripple and Noise Measurement
Ch 1: Vo (2us/div, 20mV/div)

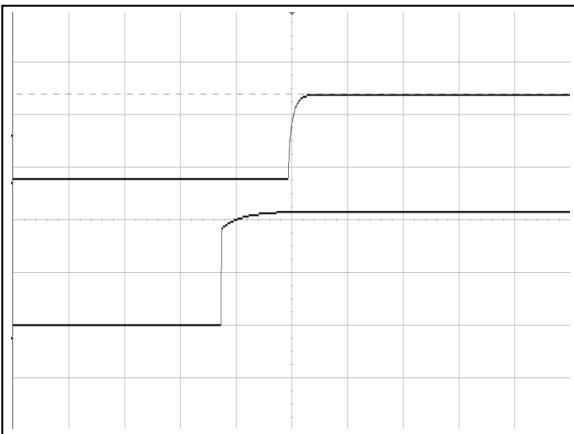

Figure 3: AVO100C-48S3V3 Turn On Characteristic (50mS/div)
Ch 1: Vo (2V/div) Ch 2: Vin (20V/div)

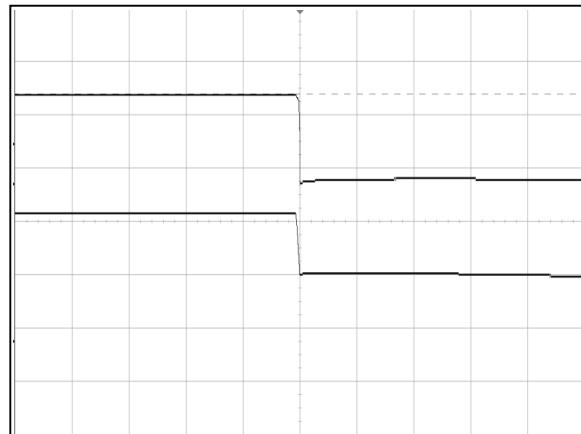

Figure 4: AVO100C-48S3V3 Turn Off Characteristic (10mS/div)
Ch 1: Vo (2V/div) Ch 2: Vin (20V/div)

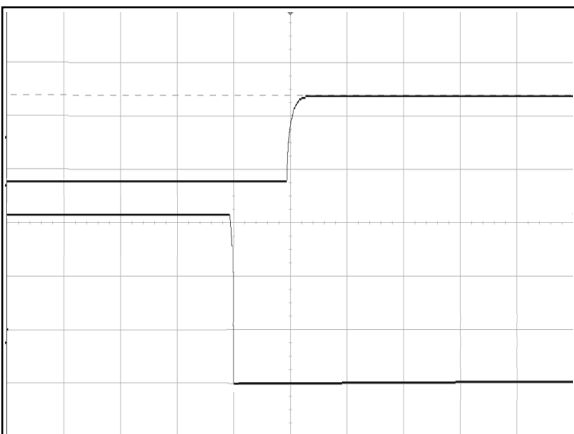

Figure 5: AVO100C-48S3V3 Remote ON Waveform (20mS/div)
Ch 1: Vo (2V/div) Ch 2: Remote ON (1V/div)

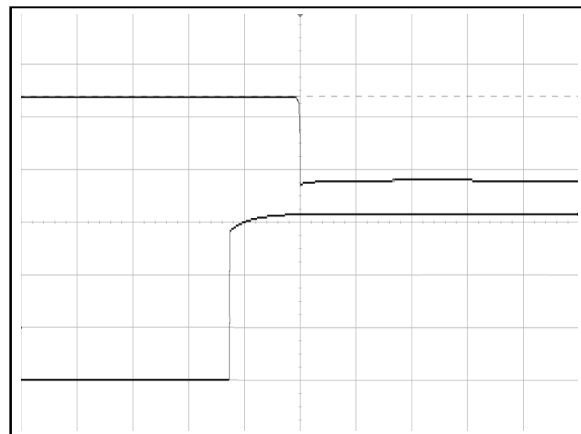

Figure 6: AVO100C-48S3V3 Remote OFF Waveform (20mS/div)
Ch 1: Vo (2V/div) CH 2: Remote OFF (1V/div)

AVO100C-48S3V3-6L Performance Curves

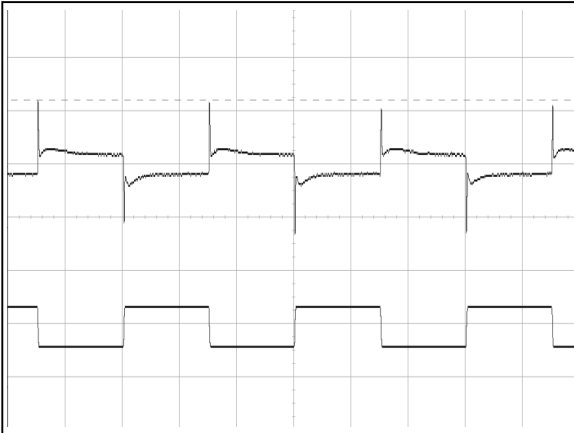

Figure 7: AVO100C-48S3V3 Transient Response (2mS/div)
 25%-50%~25% load change, 0.1A/uS slew rate
 Ch 1: Vo (50mV/div) Ch 2: Io (10A/div)

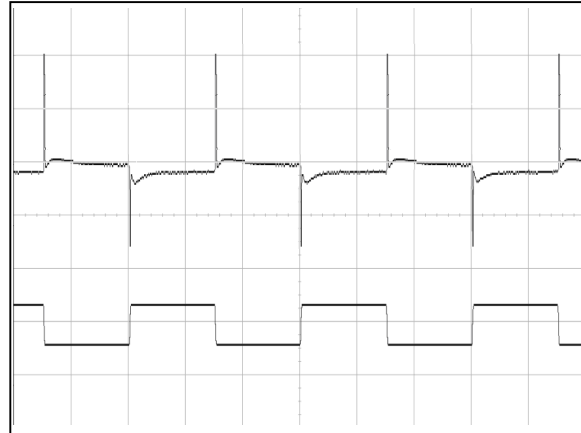

Figure 8: AVO100C-48S3V3 Transient Response (2mS/div)
 25%-50%~25% load change, 0.1A/uS slew rate
 Ch 1: Vo (50mV/div) Ch 2: Io (10A/div)

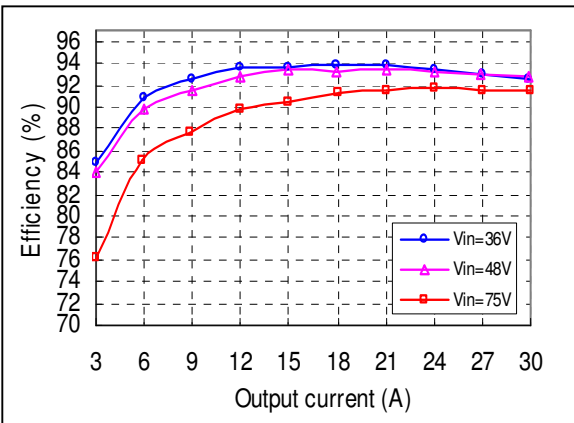

Figure 9: AVO100C-48S3V3 Efficiency Curves @ 25 degC, 300LFM
 Vo=3.3V
 Loading: Io = 10% increment to 30A

AVO100C-48S3V3B-6L Performance Curves

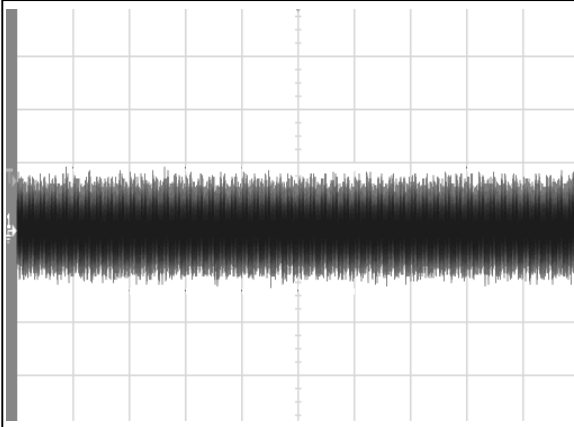

Figure 10: AVO100C-48S3V3B Input Reflected Ripple Current Waveform
Ch 1: Iin (100mS/div, 10mA/div)

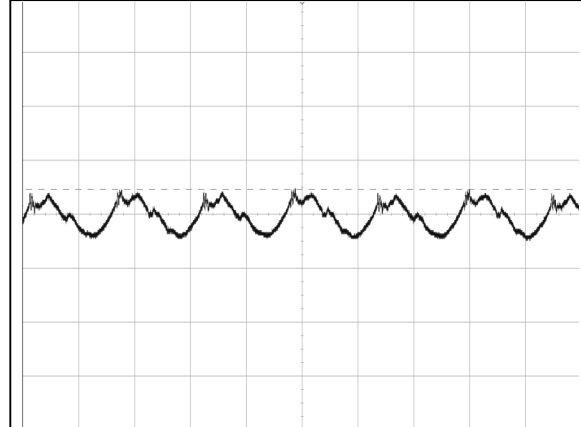

Figure 11: AVO100C-48S3V3B Ripple and Noise Measurement
Ch 1: Vo (2us/div, 20mV/div)

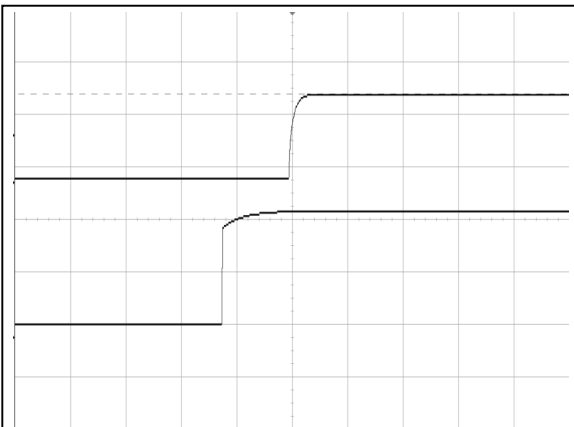

Figure 12: AVO100C-48S3V3B Turn On Characteristic (50mS/div)
Ch 1: Vo (2V/div) Ch 2: Vin (20V/div)

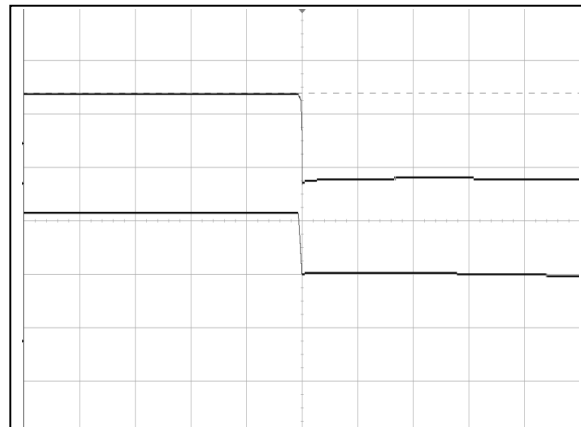

Figure 13: AVO100C-48S3V3B Turn Off Characteristic (10mS/div)
Ch 1: Vo (2V/div) Ch 2: Vin (20V/div)

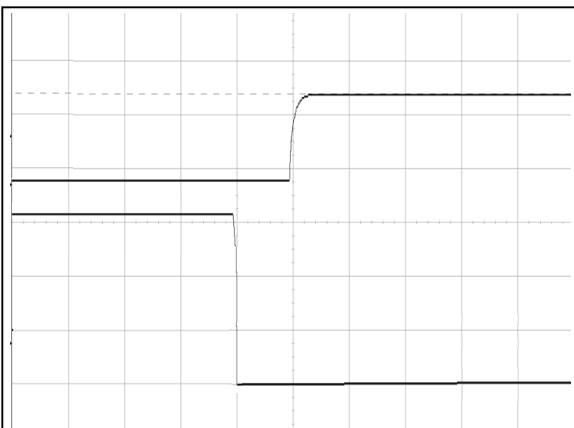

Figure 14: AVO100C-48S3V3B Remote ON Waveform (20mS/div)
Ch 1: Vo (2V/div) Ch 2: Remote ON (1V/div)

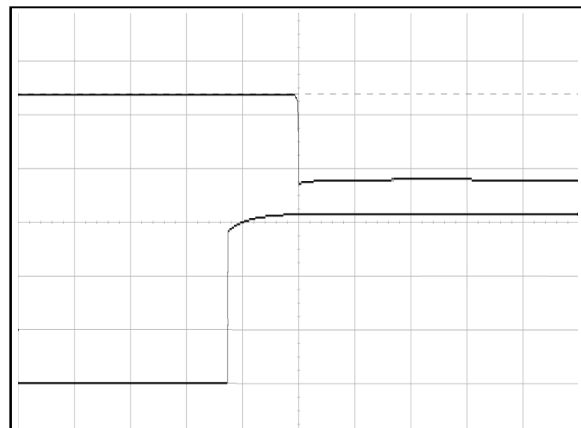

Figure 15: AVO100C-48S3V3B Remote OFF Waveform (20mS/div)
Ch 1: Vo (2V/div) CH3: Remote OFF (1V/div)

AVO100C-48S3V3B-6L Performance Curves

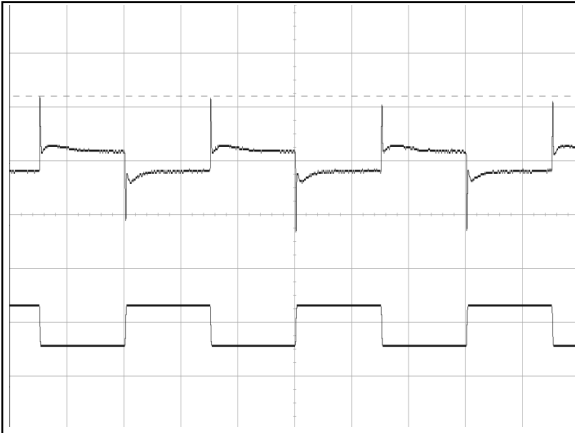

Figure 16: AVO100C-48S3V3B Transient Response (2mS/div)
 25%-50%~25% load change, 0.1A/uS slew rate,
 Ch 1: Vo (50mV/div) Ch 2: Io (10A/div)

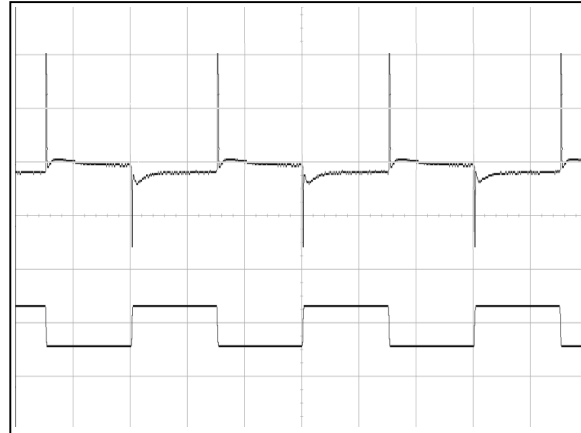

Figure 17: AVO100C-48S3V3B Transient Response (2mS/div)
 25%-50%~25% load change, 1A/uS slew rate,
 Ch 1: Vo (50mV/div) Ch 2: Io (10A/div)

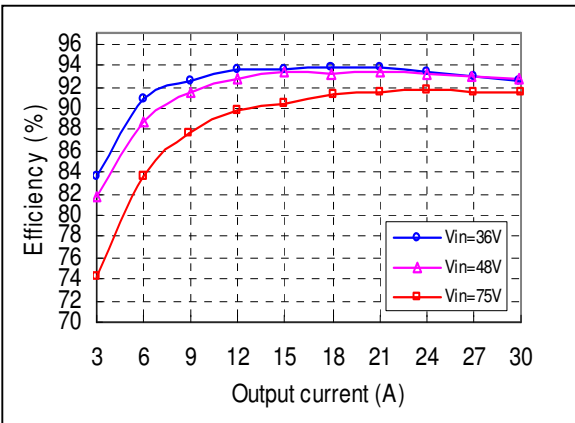
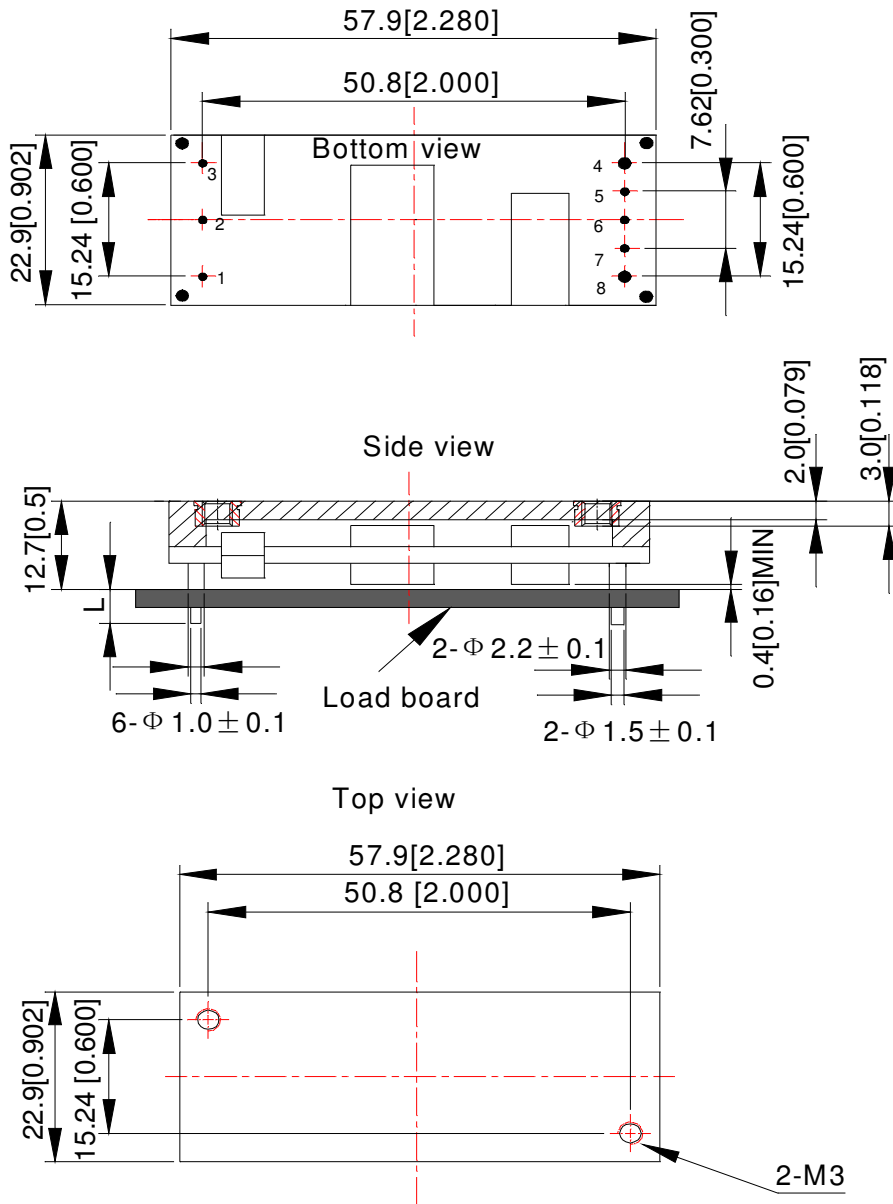

Figure 18: AVO100C-48S3V3B Efficiency Curves @ 25 degC, 300LFM
 Vo=3.3V
 Loading: Io = 10% increment to 30A

Mechanical Specifications

Mechanical Outlines – Baseplate Module

AVO100C-48S3V3B



Unit: mm[inch]

Bottom view: pin on upside

Tolerance: X.Xmm ± 0.5mm [X.X in. ± 0.02in.]

X.XXmm ± 0.25mm [X.XX in. ± 0.01in.]

Mechanical Outlines – Open-Frame Module

AVO100C-48S3V3

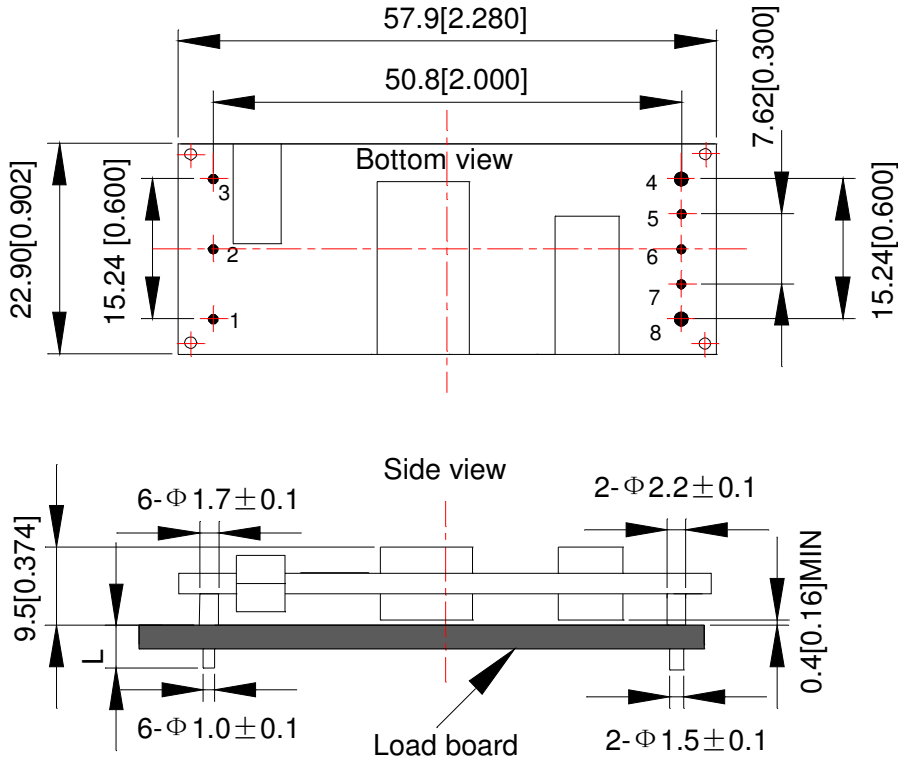

Unit: mm[inch] Bottom view: pin on upside

Tolerance: X.Xmm ± 0.5mm[X.X in. ± 0.02in.]

X.XXmm ± 0.25mm[X.XX in. ± 0.01in.]

Pin Length Option

Device code suffix	L
-4	4.8mm ± 0.25mm
-6	3.8mm ± 0.25mm
-8	2.8mm ± 0.25mm
None	5.8mm ± 0.25mm

Pin Designations

Pin No	Name	Function
1	Vin+	Positive input voltage
2	Remote On/Off	Remote control
3	Vin-	Negative input voltage
4	Vo-	Negative output voltage
5	S-	Negative remote sense
6	Trim	Output voltage trim
7	S+	Positive remote sense
8	Vo+	Positive output voltage

Environmental Specifications

EMC Immunity

AVO100C-48S3V3 series power supply is designed to meet the following EMC immunity specifications:

Table 4. Environmental Specifications:

Document	Criteria	Description
EN55022, Class A Limits	A	Conducted and Radiated EMI Limits
IEC/EN 61000-4-2, Level 3	B	Electromagnetic Compatibility (EMC) - Testing and measurement techniques - Electrostatic discharge immunity test. Enclosure Port
IEC/EN 61000-4-6, Level 2	A	Electromagnetic Compatibility (EMC) - Testing and measurement techniques, Continuous Conducted Interference. DC input port
IEC/EN 61000-4-4, Level3	B	Electromagnetic Compatibility (EMC) - Testing and measurement techniques, Electrical Fast Transient. DC input port.
IEC/EN 61000-4-5	B	Electromagnetic Compatibility (EMC) - Testing and measurement techniques, Immunity to surges - 600V common mode and 600V differential mode for DC input ports
EN61000-4-29	B	Electromagnetic Compatibility (EMC) - Testing and measurement techniques, Voltage Dips and short interruptions and voltage variations. DC input port

Criterion A: Normal performance during and after test.

Criterion B: For EFT and surges, low-voltage protection or reset is not allowed. Temporary output voltage fluctuation ceases after the disturbances ceases, and from which the EUT recovers its normal performance automatically. For dips and ESD, output voltage fluctuation or reset is allowed during the test, but recovers to its normal performance automatically after the disturbance ceases.

Criterion C: Temporary loss of output, the correction of which requires operator intervention.

Criterion D: Loss of output which is not recoverable, owing to damage to hardware.

Safety Certifications

The AVO100C-48S3V3 series power supply is intended for inclusion in other equipment and the installer must ensure that it is in compliance with all the requirements of the end application. This product is only for inclusion by professional installers within other equipment and must not be operated as a stand alone product.

Table 5. Safety Certifications for AVO100C-48S3V3 series power supply system

Document	File #	Description
UL		US Requirements
EN60950		European Requirements
IEC60950		International Requirements
CE		CE Marking
GB4943		China CCC

Operating Temperature

The AVO100C-48S3V3 series power supplies will start and operate within stated specifications at an ambient temperature from -40 °C to 85 °C under all load conditions. The storage temperature is -55 °C to 125 °C.

Thermal Considerations – Open-frame module

The converter is designed to operate in different thermal environments and sufficient cooling must be provided. Proper cooling of the DC/DC converter can be verified by measuring the temperature at the test point as shown in the Figure 19. The temperature at this point should not exceed the max values in the table 6 when the module is operating.

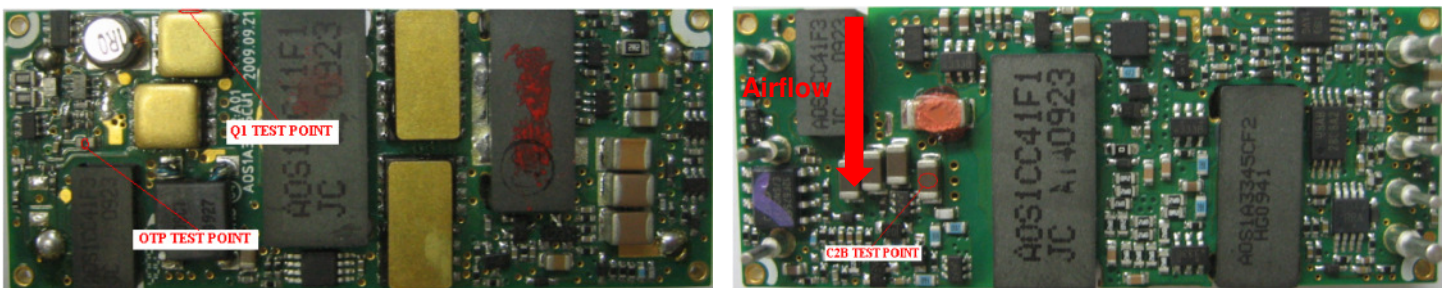

Figure 19 Temperature test point

Table 6. Temperature limit of the test point

Test Point	Temperature Limit
Q1 test point (Top)	126 °C
C2B test point (Bottom)	118 °C

For a typical application, figure 20 shows the derating of output current vs. ambient air temperature at different air velocity.

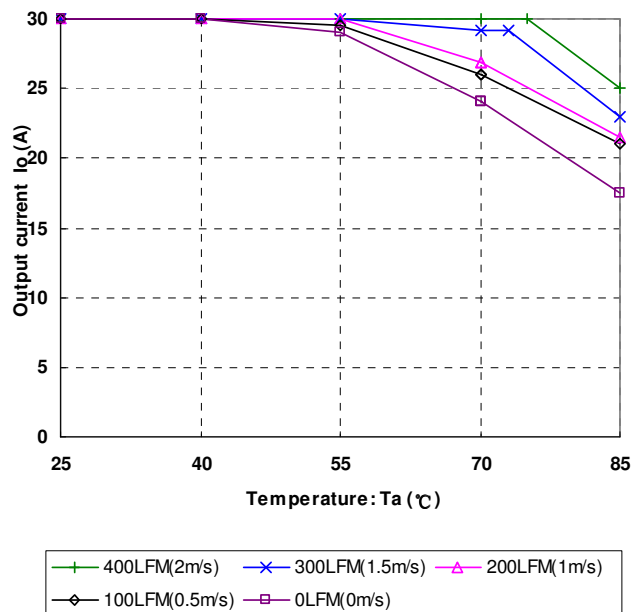

Figure 20 Output power derating, 48Vin, air flowing across the converter from pin 3 to pin 1

Thermal Considerations – Open-frame module

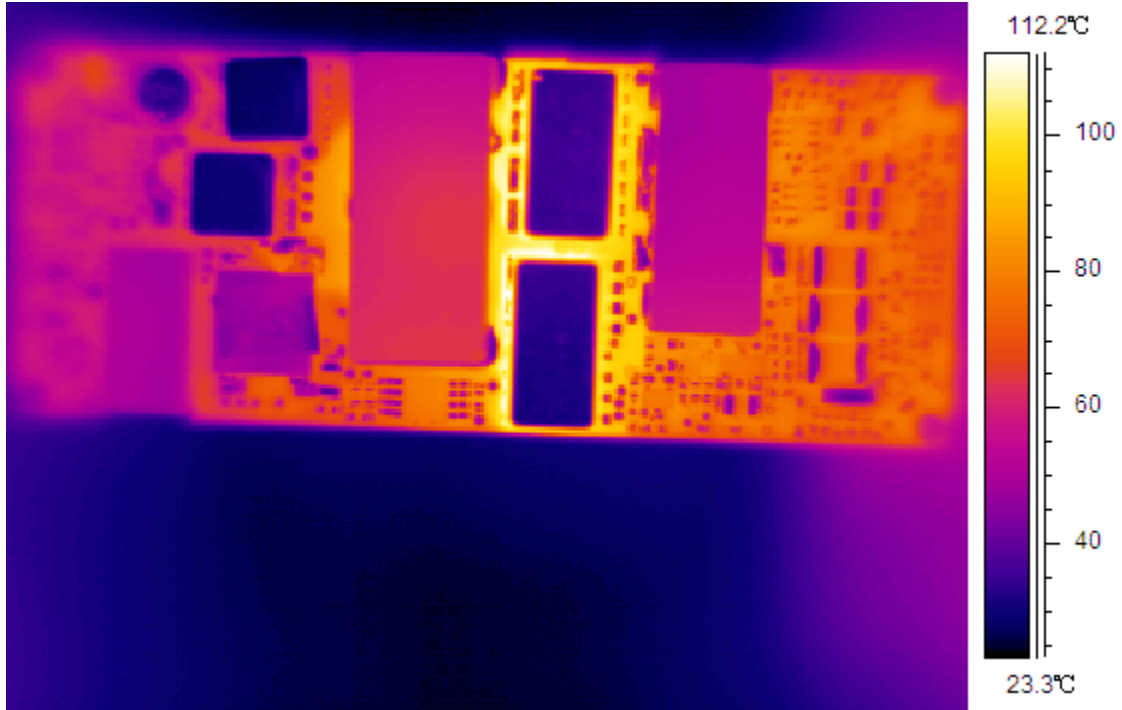

Figure 21 Thermal image, 48V_{in}, 3.3V_o, full load, room temperature, 200LFM (air flowing from pin 1 to pin 3)

Thermal Considerations –Baseplate module

The converter is designed to operate in different thermal environments and sufficient cooling must be provided. Proper cooling of the DC/DC converter can be verified by measuring the temperature at the test point as shown in the Figure 22. The temperature at this point should not exceed the max values in the table 7 when the module is operating.

Test point on baseplate

Test point on PCB

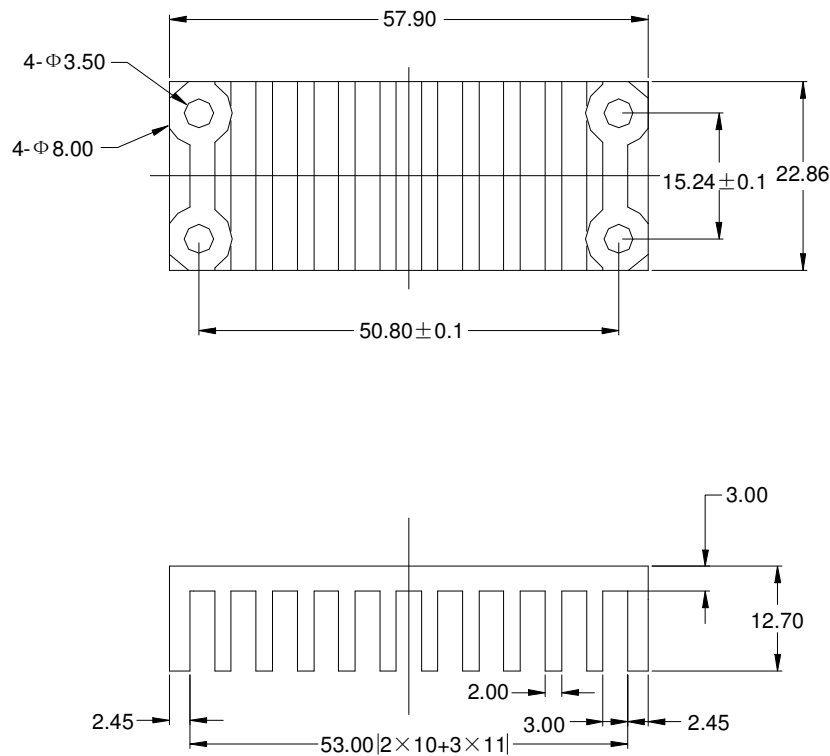
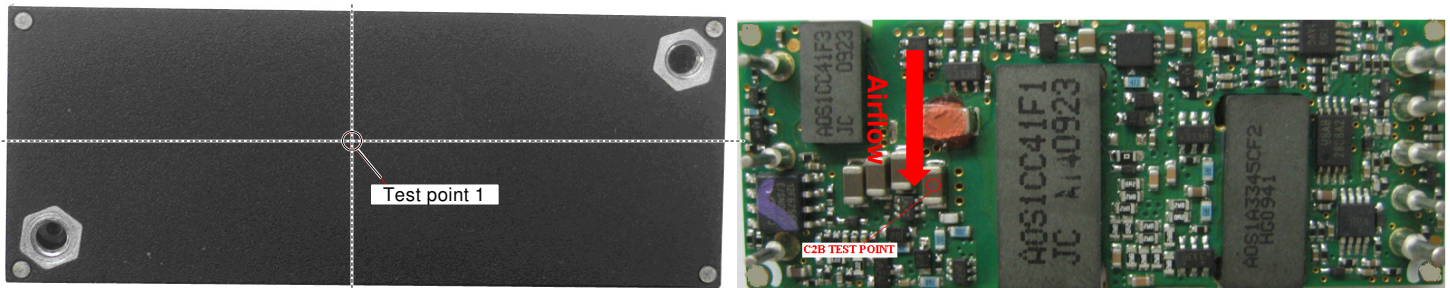

Figure 22 Temperature test point & heat sink mechanical diagram

Table 7. Temperature limit of the test point

Test Point	Temperature Limit
C2B test point on PCB	118 °C
Test point 1 on baseplate	111 °C

For a typical application, Figure 23 shows the derating output current vs ambient air temperature at different air velocity with a heat sink, the heat sink spec is shown in Figure22

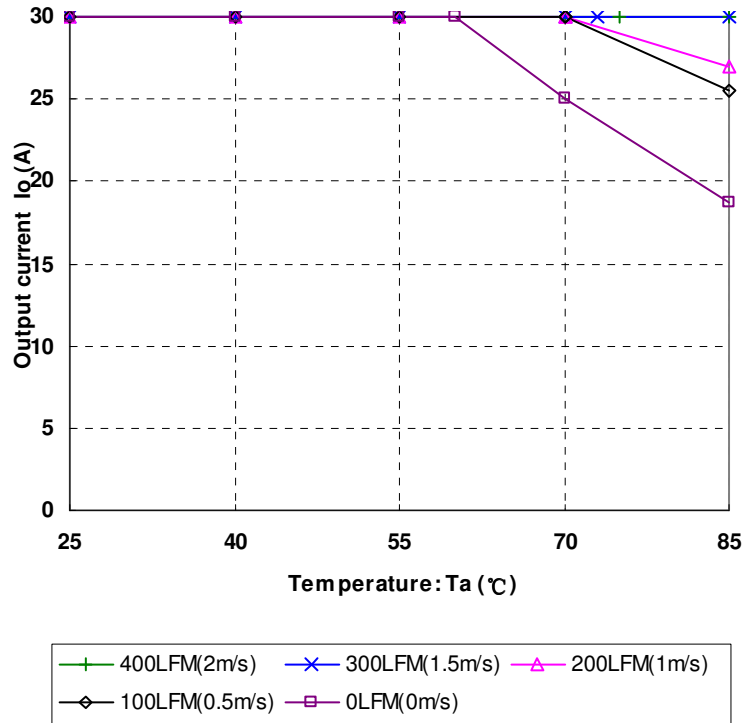

Figure 23 Output power derating, 48Vin, air flowing across the converter (from pin 3 to pin1)

Qualification Testing

Table 8. Qualification Testing:

Parameter	Unit (pcs)	Test condition
Halt test	4 ~ 5	Ta,min-10° C to Ta,max+10 °C, 5 °C step, Vin = min to max, 0 ~ 105% load
Vibration	3	Frequency range: 5Hz ~ 20Hz, 20Hz ~ 200Hz, A.S.D: 1.0m2/s3, -3db/oct, axes of vibration: X/Y/Z. Time: 30min/axis
Mechanical shock	3	30g, 6ms, 3axes, 6directions, 3time/direction
Thermal shock	3	-40 °C to 100 °C, unit temperature 20 cycles
Thermal cycling	3	-40 °C to 55 °C, temperature change rate: 1° C/min, cycle: 2
Humidity	3	40 °C, 95%RH, 48h
Solder ability	15	IPC J-STD-002C-2007

Application Notes

Typical Application

Below is the typical application of the AVO100C-48S3V3 series power supply.

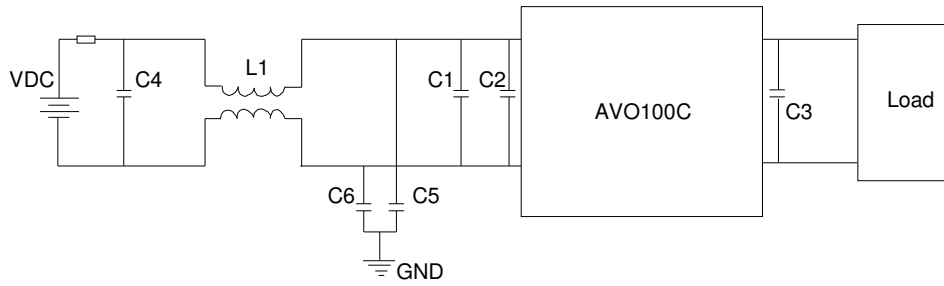

Figure 24 Typical application

C4: SMD ceramic-100V-1000nF-X7R-1210

C1: SMD ceramic-100V-100nF- $\pm 10\%$ -X7R-1206

C2: 100 μ F/100V electrolytic capacitor, high frequency and low ESR

C3: 470 μ F/10V electrolytic capacitor, high frequency and low ESR

C5, C6: SMD ceramic- 47nF/1000V/X7R-1210

L1: 1320 μ H- $\pm 25\%$ -4A-R5K-21 \times 21 \times 12.5mm

Remote ON/OFF

Negative remote ON/OFF logic is available in AVO100C-48S3V3. The logic is CMOS and TTL compatible. The voltage between pin Remote ON/OFF and pin Vin- must not exceed the range listed in table 3 to ensure proper operation. The following figure is the equivalent internal circuit and reference in AVO100C-48S3V3.

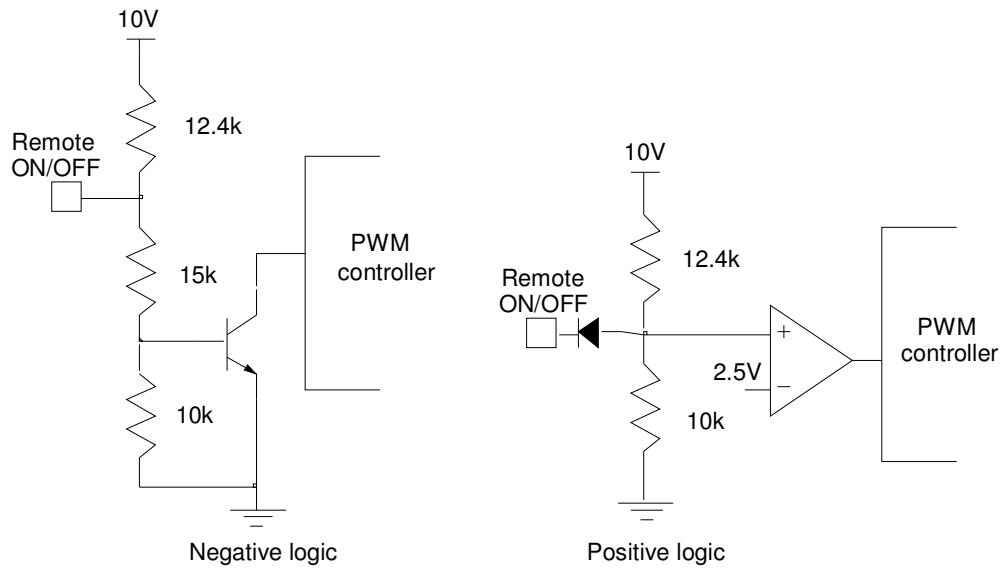

Figure 25 External Remote ON/OFF circuit

Trim Characteristics

Connecting an external resistor between Trim pin and Vo- pin will decrease the output voltage. While connecting it between Trim and Vo+ will increase the output voltage. The following equations determine the external resistance to obtain the trimmed output voltage.

$$R_{adj_down} = \left(\frac{511}{\Delta\%} - 10.22 \right) k\Omega$$

$$R_{adj_up} = \left(\frac{5.11 V_{out} (100 + \Delta\%)}{V_{ref} \Delta\%} - \frac{511}{\Delta\%} - 10.22 \right) k\Omega$$

R_{adj_down} : Value of external adjustment resistor which shall be connected between Trim and –Sense for trimming down.

$\Delta\%$: Output voltage change rate against nominal output voltage.

R_{adj_up} : Value of external adjustment resistor which shall be connected between Trim and +Sense for trimming up.

V_{out} : Nominal output voltage.

$V_{ref} = 1.225V$

When trimming up, the output current should be decreased accordingly so as not to exceed the maximum output power and the minimum input voltage should be increased as shown in below figure.

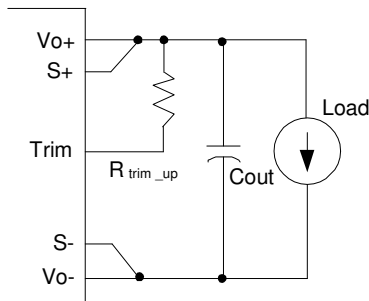

Figure 26 Trim up

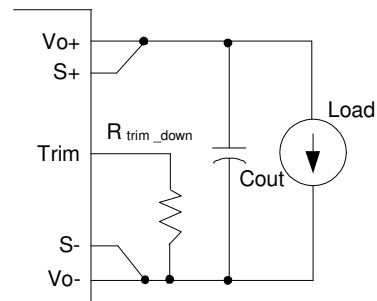

Figure 27 Trim down

Input Ripple & Output Ripple & Noise Test Configuration

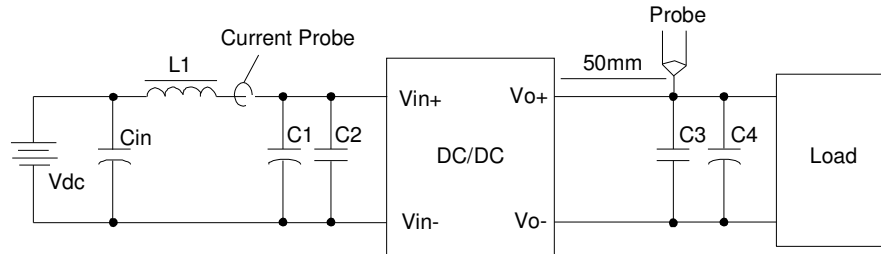

Figure 28 Input ripple & inrush current, output ripple & noise test configuration

Vdc: DC power supply

L1: 12uH

Cin: 220uF/100V typical

C1: SMD ceramic-100V-100nF- $\pm 10\%$ -X7R-1206

C2: 100 μ F/100V electrolytic capacitor, high frequency and low ESR

C3: SMD ceramic-10V-1 μ F- $\pm 10\%$ -X7R-1206

C4: 470 μ F/10V electrolytic capacitor, high frequency and low ESR

Note - Using a coaxial cable with series 50ohm resistor and 0.68uF ceramic capacitor or a ground ring of probe to test output ripple & noise is recommended.

Sense Characteristics

If the load is far from the unit, connect S+ and S- to the terminals of the load respectively to compensate the voltage drop on the transmission line.

If the sense compensation function is not necessary, connect S+ to V_o+ and S- to V_o- respectively.

Soldering

The product is intended for standard manual, reflow or wave soldering.

When reflow soldering is used, the temperature on pins is specified to maximum 260 °C for maximum 10s.

When wave soldering is used, the temperature on pins is specified to maximum 260 °C for maximum 7s.

When soldering by hand, the iron temperature should be maintained at 300 °C ~ 380 °C and applied to the converter pins for less than 10s. Longer exposure can cause internal damage to the converter.

Cleaning of solder joint can be performed with cleaning solvent IPA or similitive.

Hazardous Substances Announcement (RoHS of China)

Parts	Hazardous Substances					
	Pb	Hg	Cd	Cr ⁶⁺	PBB	PBDE
AVO100C-48S3V3	x	x	x	x	x	x
AVO100C-48S3V3B	x	x	x	x	x	x

x: Means the content of the hazardous substances in all the average quality materials of the part is within the limits specified in SJ/T-11363-2006

√: Means the content of the hazardous substances in at least one of the average quality materials of the part is outside the limits specified in SJ/T11363-2006

Artesyn Embedded Technologies has been committed to the design and manufacturing of environment-friendly products. It will reduce and eventually eliminate the hazardous substances in the products through unremitting efforts in research. However, limited by the current technical level, the following parts still contain hazardous substances due to the lack of reliable substitute or mature solution:

1. Solders (including high-temperature solder in parts) contain plumbum.
2. Glass of electric parts contains plumbum.
3. Copper alloy of pins contains plumbum

WORLDWIDE OFFICES

Americas

2900 S.Diablo Way
 Tempe, AZ 85282
 USA
 +1 888 412 7832

Europe (UK)

Waterfront Business Park
 Merry Hill, Dudley
 West Midlands, DY5 1LX
 United Kingdom
 +44 (0) 1384 842 211

Asia (HK)

14/F, Lu Plaza
 2 Wing Yip Street
 Kwun Tong, Kowloon
 Hong Kong
 +852 2176 3333



www.artesyn.com

While every precaution has been taken to ensure accuracy and completeness in this literature, Artesyn Embedded Technologies assumes no responsibility, and disclaims all liability for damages resulting from use of this information or for any errors or omissions. Artesyn Embedded Technologies, Artesyn and the Artesyn Embedded Technologies logo are trademarks and service marks of Artesyn Technologies, Inc. All other names and logos referred to are trade names, trademarks, or registered trademarks of their respective owners.
 © 2014 All rights reserved.

For more information: www.artesyn.com/power
 For support: productsupport.ep@artesyn.com