

# KIT33816FRDMEVM Evaluation Board

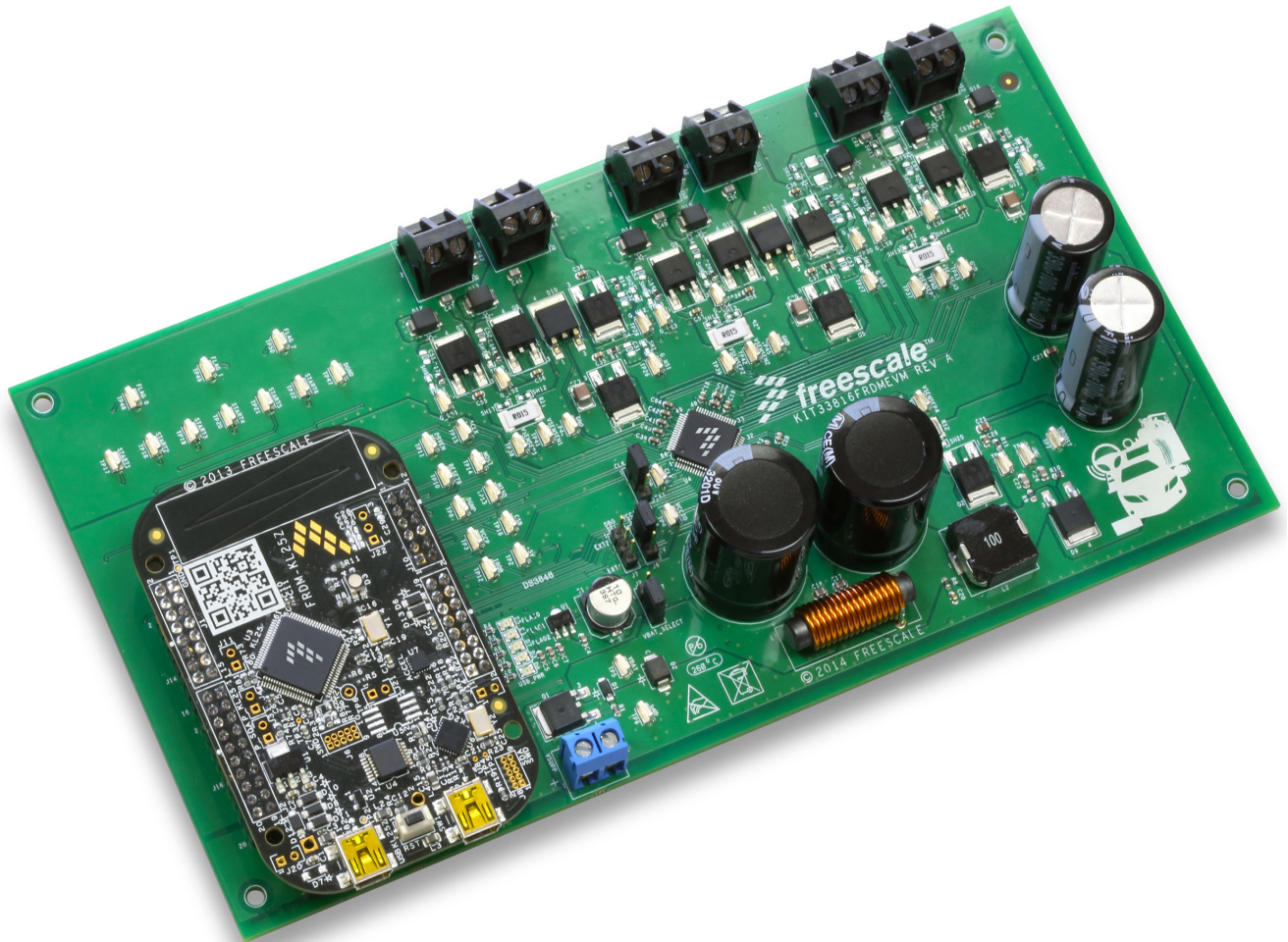

Figure 1. KIT33816FRDMEVM



# Contents

1 Important Notice .....	3
2 Getting Started .....	4
3 Understanding the System .....	5
4 Getting to Know the Hardware .....	8
5 Installing the Software and Setting up the Hardware .....	14
6 Troubleshooting .....	17
7 Schematics .....	18
8 Silkscreen .....	20
9 Bill of Materials .....	21
10 References .....	23
11 Revision History .....	24

# 1 Important Notice

Freescale provides the enclosed product(s) under the following conditions:

This evaluation kit is intended for use of ENGINEERING DEVELOPMENT OR EVALUATION PURPOSES ONLY. It is provided as a sample IC pre-soldered to a printed circuit board to make it easier to access inputs, outputs, and supply terminals. This EVB may be used with any development system or other source of I/O signals by simply connecting it to the host MCU or computer board via off-the-shelf cables. This EVB is not a Reference Design and is not intended to represent a final design recommendation for any particular application. Final device in an application will be heavily dependent on proper printed circuit board layout and heat sinking design as well as attention to supply filtering, transient suppression, and I/O signal quality.

The goods provided may not be complete in terms of required design, marketing, and or manufacturing related protective considerations, including product safety measures typically found in the end product incorporating the goods. Due to the open construction of the product, it is the user's responsibility to take any and all appropriate precautions with regard to electrostatic discharge. In order to minimize risks associated with the customers applications, adequate design and operating safeguards must be provided by the customer to minimize inherent or procedural hazards. For any safety concerns, contact Freescale sales and technical support services.

Should this evaluation kit not meet the specifications indicated in the kit, it may be returned within 30 days from the date of delivery and will be replaced by a new kit.

Freescale reserves the right to make changes without further notice to any products herein. Freescale makes no warranty, representation or guarantee regarding the suitability of its products for any particular purpose, nor does Freescale assume any liability arising out of the application or use of any product or circuit, and specifically disclaims any and all liability, including without limitation consequential or incidental damages. "Typical" parameters can and do vary in different applications and actual performance may vary over time. All operating parameters, including "Typical", must be validated for each customer application by customer's technical experts.

Freescale does not convey any license under its patent rights nor the rights of others. Freescale products are not designed, intended, or authorized for use as components in systems intended for surgical implant into the body, or other applications intended to support or sustain life, or for any other application in which the failure of the Freescale product could create a situation where personal injury or death may occur.

Should the buyer purchase or use Freescale products for any such unintended or unauthorized application, the buyer shall indemnify and hold Freescale and its officers, employees, subsidiaries, affiliates, and distributors harmless against all claims, costs, damages, and expenses, and reasonable attorney fees arising out of, directly or indirectly, any claim of personal injury or death associated with such unintended or unauthorized use, even if such claim alleges that Freescale was negligent regarding the design or manufacture of the part. Freescale™ and the Freescale logo are trademarks of Freescale Semiconductor, Inc. All other product or service names are the property of their respective owners.

© Freescale Semiconductor, Inc. 2014.

## 2 Getting Started

### 2.1 Kit Contents/Packing List

The **KIT33816FRDMEVM** contents include:

- Assembled and tested evaluation board in an anti-static bag
- Quick Start Guide, Analog Tools
- Warranty card

### 2.2 Jump Start

Freescale's analog product development boards help to easily evaluate Freescale products. These tools support analog mixed signal and power solutions including monolithic ICs using proven high-volume SMARTMOS mixed signal technology, and system-in-package devices utilizing power, SMARTMOS and MCU dies. Freescale products enable longer battery life, smaller form factor, component count reduction, ease of design, lower system cost and improved performance in powering state of the art systems.

- Go to [www.freescale.com/analogtools](http://www.freescale.com/analogtools)
- Locate the kit
- Review the Tool Summary Page
- Look for



- Download documents, software, and other information

Once the files are downloaded, review the user guide in the bundle. The user guide includes setup instructions, BOM and schematics. Jump start bundles are available on each tool summary page with the most relevant and current information. The information includes everything needed for design.

### 2.3 Required Equipment and Software

To use this kit, you need:

- Power supply 12 V with current limit set initially to 4.0 A
- Oscilloscope (four-channel preferably) with current probe(s) (10 MHz bandwidth)
- SPIGen 7.0 or greater [www.freescale.com/analogtools](http://www.freescale.com/analogtools)
- USB to mini USB cable to connect the computer to the KL25Z

### 2.4 System Requirements

The kit requires the following to function properly with the software:

- USB-enabled PC with Windows® XP or higher

### 3 Understanding the System

KIT33816FRDMEVM uses the freedom board KL25Z to communicate with the MC33816 by SPI to setup registers and flash CRAM and DRAM. The KL25Z is also controlling the start and end of injection thanks to the STARTx pins. This particular application drives four injectors, two fuel pumps and an external DCDC.

#### 3.1 Block Diagram

The high level system block diagram (Figure 2) outlines the way the Freescale standard products are used to implement this particular application of four cylinders (INJ1, INJ2, INJ3 and INJ4) and two fuel pump (FP1 and FP2). Communication between the KL25Z and MC33816 is done by SPI, control and reporting is done through I/Os.

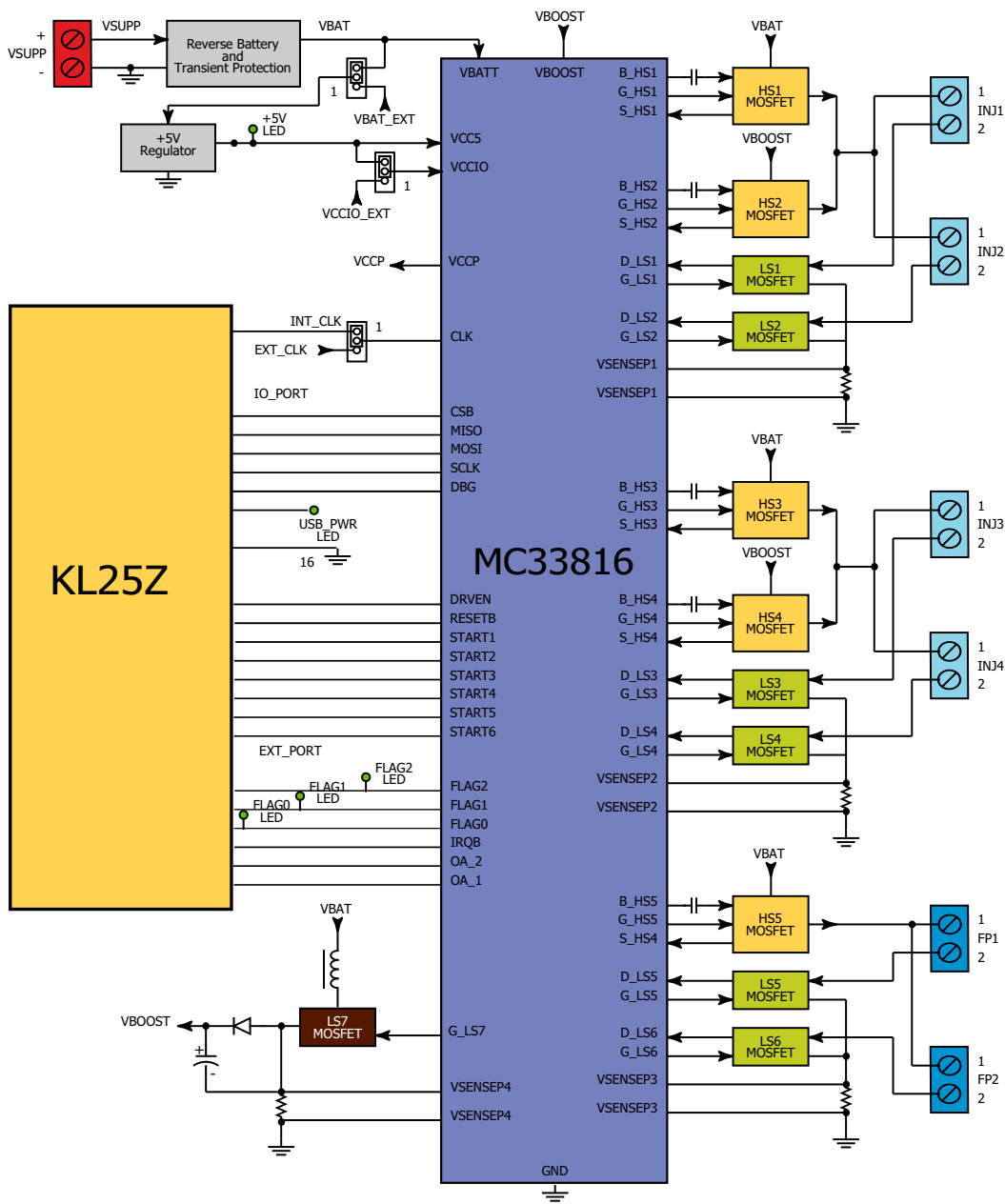

Figure 2. Block Diagram

### 3.1.1 Device Features

This evaluation board features the following Freescale products:

**Table 1. MC33816 Device Features**

Device	Description	Features
MC33816	Programmable Solenoid Controller, 5 high-sides and 7 low-sides	<ul style="list-style-type: none"> <li>Battery voltage range, 5.5 V &lt; VBATT &lt; 32 V <sup>(1)</sup></li> <li>Pre-drive operating voltage up to 72 V</li> <li>High-side/low-side pre-drive PWM capability up to 100 kHz</li> <li>All pre-drivers with four selectable slew rates</li> <li>Eight selectable, pre-defined VDS monitoring thresholds</li> <li>Encryption for microcode protection</li> <li>Integrated 1.0 MHz back-up clock</li> </ul>
<p>Note:</p> <p>1. In case VSUPP &gt; 16 V, it is highly recommended to disable the internal VCCP regulator and externally supply VCCP.</p>		

### 3.2 FRDM-KL25Z Freedom Development Platform

The Freescale Freedom development platform is a set of software and hardware tools for evaluation and development. It is ideal for rapid prototyping of microcontroller-based applications. The Freescale Freedom KL25Z hardware, FRDM-KL25Z, is a simple, yet sophisticated design featuring a Kinetis L Series microcontroller, the industry's first microcontroller built on the ARM® Cortex™-M0+ core.

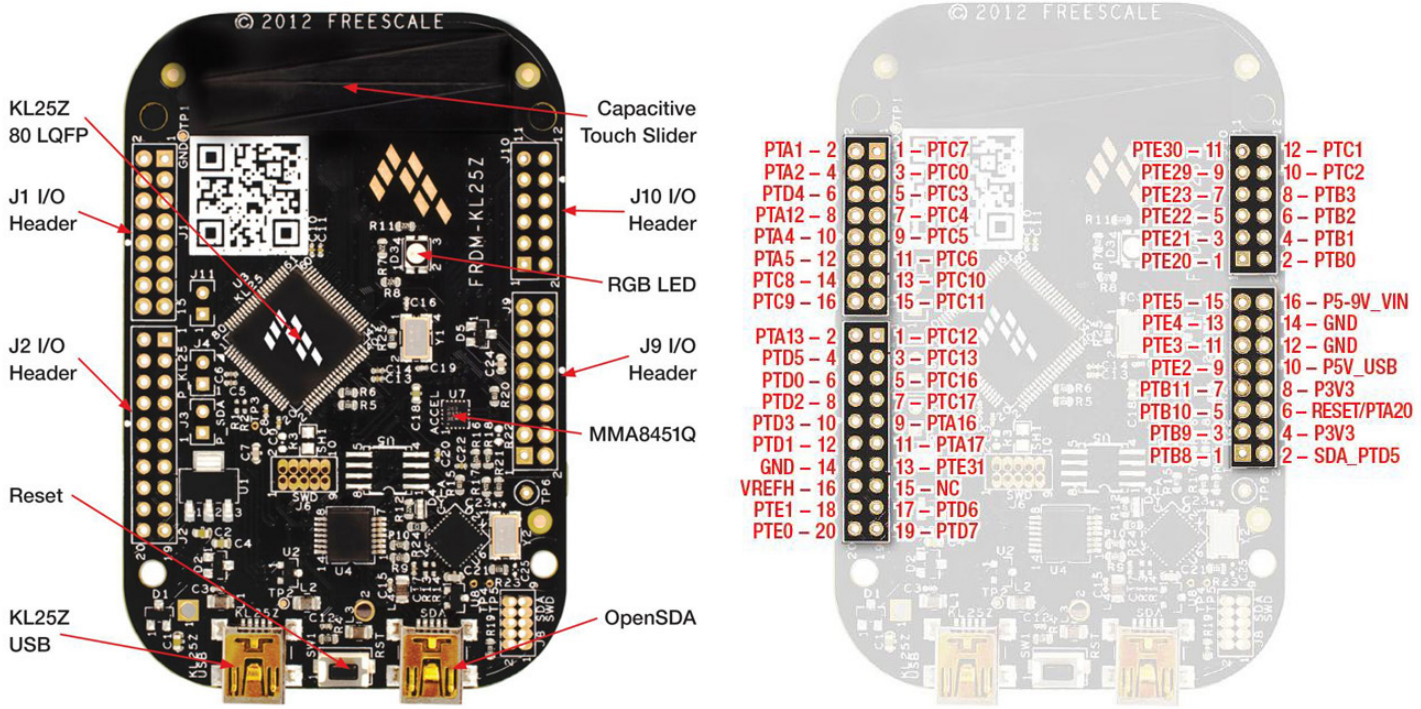

**Figure 3. FRDM-KL25Z**

## 3.3 Connecting the FRDM-KL25Z Freedom Development Platform

KIT33816FRDMEVM includes a KL25Z already flashed in order to use it as a SPI dongle to control the MC33816.

Only plug in a USB cable from a USB host to the KL25Z mini-B USB connector and SPIGEN (7.xx and above) are needed to use the kit. The following chapters, [Section 3.3.1](#) through [Section 3.3.4](#) are optional and only required if a software update is needed or if the user wants to reprogram the KL25Z to develop their own application.

### 3.3.1 Installing the Drivers (Optional)

To flash the Freedom board using drag and drop from Windows Explorer, USB Drivers and OpenSDA Firmware (MSD & Debug) from P&E Micro [www.pemicro.com/opensda](http://www.pemicro.com/opensda) must be loaded on the board.

### 3.3.2 Enter OpenSDA Bootloader Mode (Optional)

1. Unplug the USB cable if attached.
2. Press and hold the Reset button (SW1).
3. Plug in a USB cable between a USB host and the OpenSDA USB connector (labeled SDAII).
4. Release the Reset button.

A removable drive is visible in the host file system with a volume label of BOOTLOADER. You are now in OpenSDA Bootloader mode.

### 3.3.3 Load an OpenSDA Application (Optional)

1. Locate the OpenSDA Applications folder from the downloaded zip file.
2. Copy and paste or drag and drop the MSD Flash Programmer Application (MSD-FRDM-KL25Z\_vXYZ\_Pemicro.SDA) to the BOOTLOADER drive (Make sure to unzip the file before doing the paste or drop).
3. Unplug the USB cable and plug it into the SDA USB Connector. The new OpenSDA Application is now running and a FRDM-KL25Z drive visible in the host file system.

### 3.3.4 Using the MSD Flash Programmer (Optional)

1. Locate SPIGEN UsbSpiDongleKL25Z\_XXX.srec image folder in SPIGEN folder (C:\Program Files (x86)\SPIGen\SPI Dongle Firmware).
2. Copy and paste or drag and drop the .srec files to the FRDM-KL25Z drive.
3. Unplug the USB cable for the open SDA USB Connector and plug it to the USB\_KL25Z.

## 4 Getting to Know the Hardware

### 4.1 Board Overview

The KIT33816FRDMMEVM is an easy-to-use circuit board allowing the user to exercise all the functions of the MC33816 Smart Pre-driver circuit. A PC communicates to the Evaluation Board (EVB) through a Freedom Board (FRDM-KL25Z) connected to the PC's USB port. The Freescale SPIGen program (version 7.0 and above) provides the user interface to the MC33816 SPI port and allows the user to program the Code RAM and Data Registers, send commands to the IC and receive status from the IC.

### 4.2 Board Features

The board features are as follows:

- MC33816 Direct Injection Pre-driver Integrated Circuit
- USB-to-SPI dongle interface using the FRDM-KL25Z
- External MOSFETs
- Power-conditioning circuitry
- +5.0 V regulator supplies all +5.0 V power required by the MC33816 EVB
- +12 V VSUPP provides the power to the MC33816 and the loads

### 4.3 FRDM-KL25Z Features

The FRDM-KL25Z board features are as follows:

- MKL25Z128VLK4 MCU - 48 MHz, 128 KB Flash, 16 KB SRAM, USB OTG (FS), 80LQFP
- Capacitive touch slider, MMA8451Q accelerometer, Tri-color LED
- Flexible power supply options - USB, coin cell battery, external source
- Easy access to MCU I/O
- Battery-ready, power-measurement access points
- Form factor compatible with Arduino™ R3 pin layout
- New, OpenSDA debug interface
- Mass storage device flash programming interface (default) - no tool installation required to evaluate demonstration applications
- P&E Debug interface provides run-control debugging and compatibility with IDE tools
- CMSIS-DAP interface: new ARM standard for embedded debug interface

Additional reference documents are available on [freescale.com/FRDM-KL25Z](http://freescale.com/FRDM-KL25Z)



### 4.4 Board Description

The analog part consists of the MC33816 chip controlling external drivers. The digital part consists of the KL25Z controlling the MC33816 by SPI and I/Os.

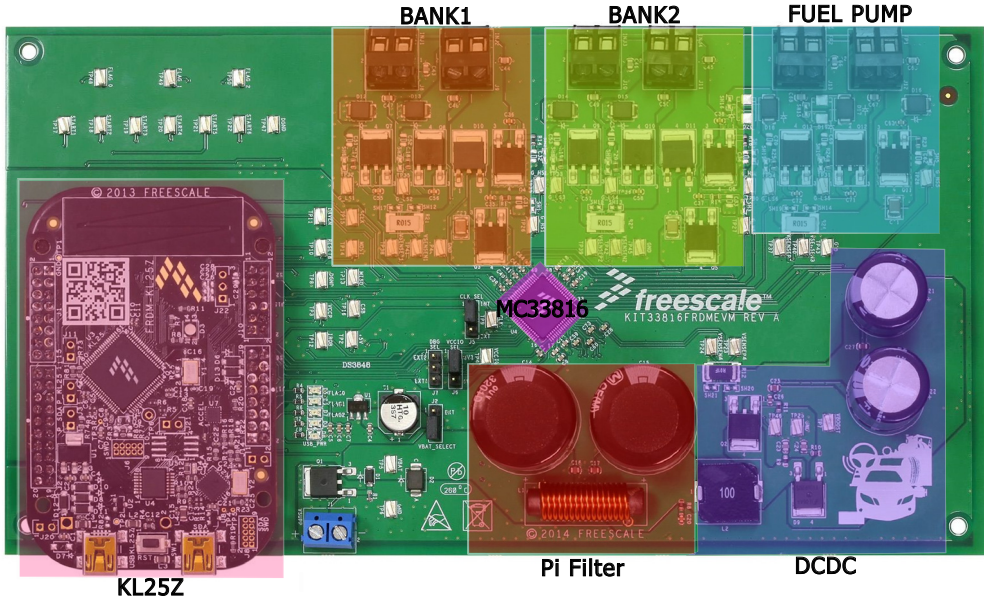

Figure 4. Board Description

Table 2. Board Description

Name	Description
KL25Z	<ul style="list-style-type: none"> <li>Microcontroller used to communicate with the computer by a USB to the MC33816 by SPI</li> </ul>
DCDC	<ul style="list-style-type: none"> <li>DCDC converter to generate BOOST voltage</li> </ul>
BANK1	<ul style="list-style-type: none"> <li>Injectors Bank1: 2 high-side + 2 low-side ton control injectors 1 and 2</li> </ul>
BANK2	<ul style="list-style-type: none"> <li>Injectors Bank2: 2 high-side + 2 low-side ton control injectors 3 and 4</li> </ul>
Fuel Pump	<ul style="list-style-type: none"> <li>1 high-side + 2 low-side to control Fuel Pump 1 and 2</li> </ul>
MC33816AE	<ul style="list-style-type: none"> <li>Programmable Solenoid Controller</li> </ul>
Pi Filter	<ul style="list-style-type: none"> <li>Pi Filter circuits remove unwanted or undesired frequencies</li> </ul>

## 4.5 LED Display

Five LED's are provided as visual output devices for the MC33816 evaluation board. The LED devices are:

1. FLAG0 LED - Indicates that the digital FLAG 0 output is a logic 1.
2. FLAG1 LED - Indicates that the digital FLAG 1 output is a logic 1.
3. FLAG2 LED - Indicates that the digital FLAG 2 output is a logic 1.
4. +5.0 V LED - Indicates that the +5.0 volt regulator is running.
5. USB\_PWR LED - Indicates that the KL25Z FRDM is connected properly and is attached to an active USB port on a PC.

## 4.6 Test Point Definitions

The MC33816 EVB contains 48 test points that provide access to certain signals in the MC33816 as follows:

**Table 3. Test Point Definitions**

TP #	Signal Name	Description
1	+5.0 V	+5.0 Volt regulator output
2	VCCP	VCCP device pin
3	VCCIO	VCCIO device pin
4	VBAT	VBAT device pin
5	PGND	power ground
6	VBOOST	DC-DC convertor output, 0 to 72 V
7	DGND	digital ground
8	CLK	CLK device pin for external clocking
9	RESETB	RESETB device pin for reset
10	DRVEN	DRVEN device pin for enabling the pre-drivers
11	IRQB	IRQB device pin, output for MCU hardware interrupt
12	MISO	MISO device pin for SPI for data out
13	MOSI	MOSI device pin for SPI for data in
14	SCLK	SCLK device pin for SPI clock
15	CSB	CSB device pin for SPI chip select
16	START1	START1 device pin for injector 1 (INJ1) output control
17	START2	START2 device pin for injector 2 (INJ2) output control
18	START3	START3 device pin for injector 3 (INJ3) output control
19	START4	START4 device pin for injector 4 (INJ4) output control
20	START5	START5 device pin for fuel pump 1 (FP1) output control
21	START6	START6 device pin for fuel pump 2 (FP2) output control
22	VSENSE4	VSENSE4 device pin, voltage across R12 current sense resistor for the DC-DC converter
23	VSENSE4	VSENSE4 device pin, voltage across R12 current sense resistor for the DC-DC converter
24	PGND	power ground
25	G_HS1	G_HS1 device pin for HS1 driver control
26	G_HS3	G_HS3 device pin for HS3 driver control
27	G_HS5	G_HS5 device pin for HS5 driver control
28	G_HS2	G_HS2 device pin for HS2 driver control
29	G_HS4	G_HS4 device pin for HS4 driver control
30	G_LS5	G_LS5 device pin for LS5 driver control
31	G_LS1	G_LS1 device pin for LS1 driver control
32	G_LS3	G_LS3 device pin for LS3 driver control
33	G_LS6	G_LS6 device pin for LS6 driver control
34	G_LS2	G_LS2 device pin for LS2 driver control
35	G_LS4	G_LS4 device pin for LS4 driver control
36	VSENSE3	VSENSE3 device pin, voltage across R26 current sense resistor for the fuel pump bank
37	VSENSE1	VSENSE1 device pin, voltage across R21 current sense resistor for the injector bank 1
38	VSENSE2	VSENSE2 device pin, voltage across R22 current sense resistor for the injector bank 2
39	VSENSE3	VSENSE3 device pin, voltage across R26 current sense resistor for the fuel pump bank

**Table 3. Test Point Definitions (continued)**

TP #	Signal Name	Description
40	VSENSEN1	VSENSEN1 device pin, voltage across R21 current sense resistor for the injector bank 1
41	VSENSEN2	VSENSEN2 device pin, voltage across R22 current sense resistor for the injector bank 2
42	PGND	power ground
43	PGND	power ground
44	PGND	power ground
45	G_LS7	G_LS7 device pin for LS7 driver control
46	FLAG0	FLAG0 device pin
47	FLAG1	FLAG1 device pin
48	FLAG2	FLAG2 device pin

## 4.7 Input Signal Definitions

The MC33816 EVB has nine logic level input signals used to control certain outputs or functions inside the circuit are:

1. DRVEN - Controls the state of the all the pre-driver outputs
2. RESETB - When the RESETB line is held low, the MC33816 is reset
3. START1 - Provides start signal for Injector 1
4. START2 - Provides start signal for Injector 2
5. START3 - Provides start signal for Injector 3
6. START4 - Provides start signal for Injector 4
7. START5 - Provides start signal for Fuel Pump 1
8. START6 - Provides start signal for Fuel Pump 2
9. DBG - Provides the trace signal if activated
10. CLK - Provides 1 MHz CLK to the MC33816

## 4.8 Screw Terminal Connections

The MC33816 EVB contains four injector outputs, two fuel pump outputs, and one VSUPP input screw terminal connection.

## 4.9 Pin Jumpers

There are four 3-pin jumper headers on the MC33816 EVB.

1. VBAT\_SELECT - This is a header to supply the +5.0 V linear regulator from VSUPP (position 2-3) or from the VBAT\_EXT.
2. VCCIO\_SEL - This is a header to Supply VCCIO from the +5.0 V regulator (position 2-3) or from the 3.3 V coming from the KL25Z. If KL25Z is used this jumper should always be in 3.3 V position since the **KL25Z has a 3.3 V logic** (position 1-2).
3. CLK\_SEL - This is a header to select the KL25Z Oscillator set to 1 MHz (position 1-2) or an external clock pin (position 2-3).
4. DBG\_SEL - This header is not populated in this board revision, since DBG is connected directly to the KL25Z.

## 4.10 MC33816 EVB Connectors

### 4.10.1 Input Connector

There is one input connector used to connect the MC33816 EVB to +12 V.

1. (VSUPP) +12 VOLT POWER SUPPLY INPUT -  
Screw Terminal 1 (+) +12 V  
Screw Terminal 2 (-) GND

## 4.10.2 Output Connectors

There are six output connectors that provide the four injector and two fuel pump output signals:

1. (INJ1) INJECTOR OUTPUT 1 -  
Screw Terminal 1 - High-side drive  
Screw Terminal 2 - Low-side drive
2. (INJ2) INJECTOR OUTPUT 2 -  
Screw Terminal 1 - High-side drive  
Screw Terminal 2 - Low-side drive
3. (INJ3) INJECTOR OUTPUT 3 -  
Screw Terminal 1 - High-side drive  
Screw Terminal 2 - Low-side drive
4. (INJ4) INJECTOR OUTPUT 4 -  
Screw Terminal 1 - High-side drive  
Screw Terminal 2 - Low-side drive
5. (FP1) FUEL PUMP OUTPUT 1 -  
Screw Terminal 1 - Low-side drive  
Screw Terminal 2 - High-side drive
6. (FP2) FUEL PUMP OUTPUT 2 -  
Screw Terminal 1 - Low-side drive  
Screw Terminal 2 - High-side drive

## 4.11 Freedom Board FRDM - KL25Z Connectors

The KL25Z board is to be plugged into the four male connectors J14 - 17, attached with the kit four female connectors are included and should be soldered directly on the KL25Z.

**Table 4. KL25Z J14 Pin-out**

Pin	SPIGen Signal	Pin	SPIGen Signal
J14 01	(IRQ)	J14 02	
J14 03	(DBG)	J14 04	
J14 05	(CLK)	J14 06	(FLAG0)
J14 07	(FLAG1)	J14 08	
J14 09	(FLAG2)	J14 10	
J14 11	(FLAG3)	J14 12	
J14 13		J14 14	
J14 15		J14 16	

**Table 5. KL25Z J16 Pin-out**

Pin	SPIGen Signal	Pin	SPIGen Signal
J16 01	DATA0 (DRVEN)	J16 02	
J16 03	DATA1 (RESETB)	J16 04	
J16 05	DATA2 (START1)	J16 06	SPI0-CSB
J16 07	DATA3 (START2)	J16 08	SPI0-MOSI
J16 09	DATA4 (START3)	J16 10	SPI0-MISO
J16 11	CTRL0 (START4)	J16 12	SPI0-SCLK

**Table 5. KL25Z J16 Pin-out (continued)**

Pin	SPIGen Signal	Pin	SPIGen Signal
J16 13	CTRL1 (START5)	J16 14	
J16 15		J16 16	
J16 17		J16 18	
J16 19	CTRL2 (START6)	J16 20	

**Table 6. KL25Z J17 Pin-out**

Pin	SPIGen Signal	Pin	SPIGen Signal
J17 01		J17 02	
J17 03		J17 04	
J17 05		J17 06	
J17 07		J17 08	
J17 09		J17 10	USB PWR
J17 11		J17 12	GND
J17 13		J17 14	GND
J17 15		J17 16	

**Table 7. KL25Z J15 Pin-out**

Pin	SPIGen Signal	Pin	SPIGen Signal
J15 01	ADC0 DP0 (OA1)	J15 02	
J15 03	ADC0 DM0 (OA2)	J15 04	
J15 05		J15 06	
J15 07		J15 08	
J15 09		J15 10	
J15 11		J15 12	

# 5 Installing the Software and Setting up the Hardware

## 5.1 Installing SPIGen Freeware on your Computer

The latest version of SPIGen is designed to run on Windows 8, Windows 7, Vista or XP-based operating systems. To install the software, go to [www.freescale.com/analogtools](http://www.freescale.com/analogtools) and select your kit. Click on that link to open the corresponding Tool Summary Page. Look for "Jump Start Your Design". Download to your computer desktop the SPIGen software as well as the associated configuration file.

Run the install program from the desktop. The Installation Wizard conducts the rest of the process.

To use SPIGen, go to the Windows Start menu, then Programs, then SPIGen, and click on the SPIGen icon. The SPIGen Graphic User Interface (GUI) appears. Go to the file menu in the upper left hand corner of the GUI, and select "Open". In the file selection window that appears, set the "Files of type:" drop-down menu to "SPIGen Files (\*.spi)". (As an exceptional case, the file name may have a .txt extension, in which case, set the menu to "All Files (\*.\*)".) Next, browse for the configuration file that was saved on the desktop earlier and select it. Click "Open", and SPIGen creates a specially configured SPI command generator for your evaluation board.

The GUI is shown in **Figure 5**. The text at the top is the name of the configuration file loaded. The left side panel displays folders that group user interfaces. The interfaces in the pre-installed MC33816 folder pertain specifically to the board under discussion. The process of loading the configuration file has assigned a list of "Extra Pins" as well as a list of "Quick Commands", all of which are board-specific.

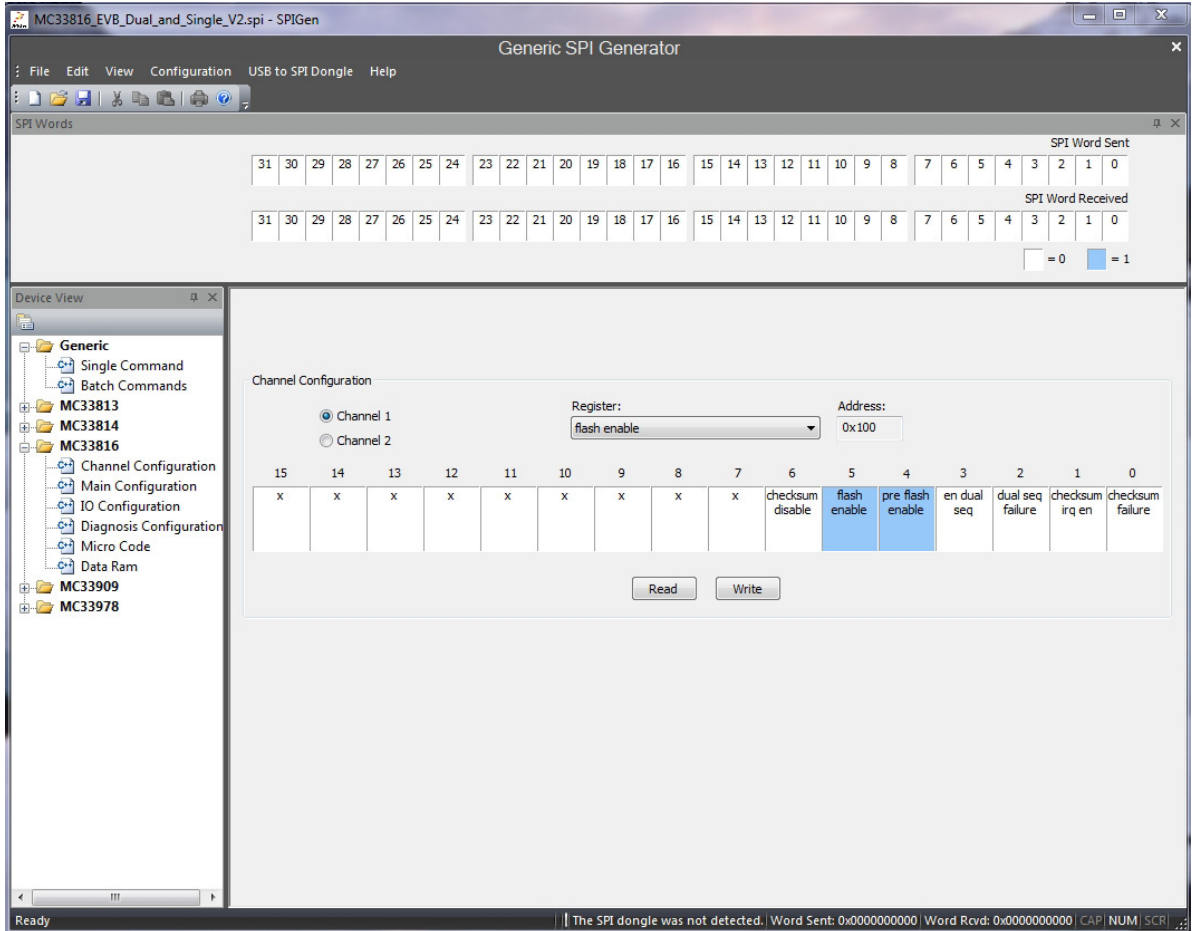

**Figure 5. SPIGen GUI**

## 5.2 Configuring the Hardware

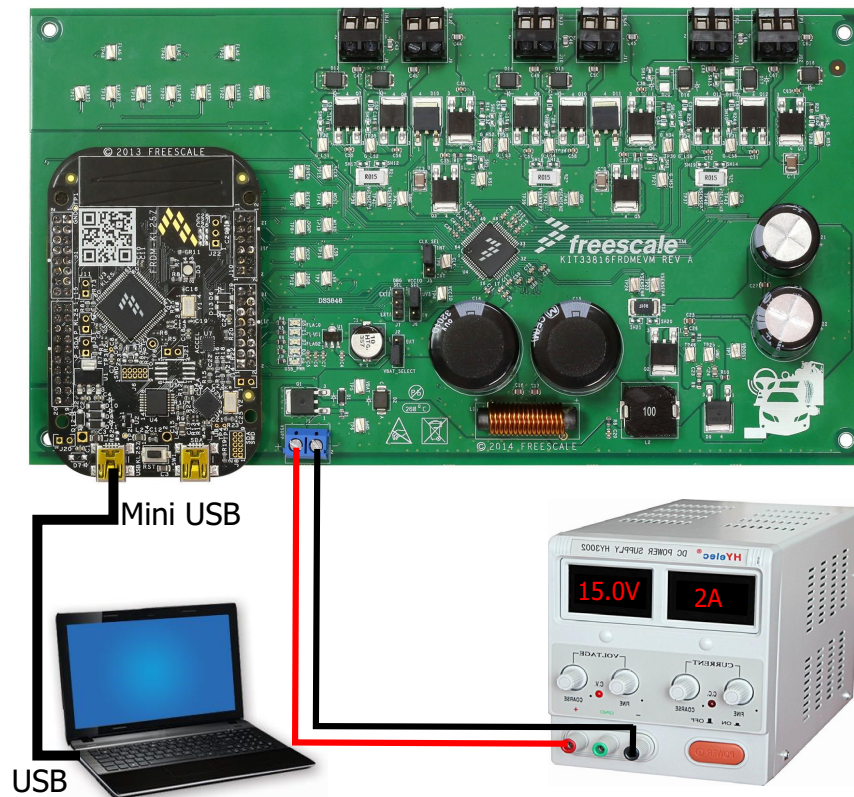

Figure 6. KIT33816FRDMEVM Board Setup

## 5.3 Step-by-step Instructions for Setting up the Hardware using SPIGen

To perform the examples included in the software bundle, the following connections and setup must be performed:

1. Make sure SPIGen 7.0 (or higher) is installed on the PC and it can communicate with the Freedom board KL25Z, as described in that kit's documentation. (See Section 5.1).
2. Connect the KL25Z to the PC using the USB KL25Z port (left side of SW1). The USB\_PWR LED on the MC33816 EVB should be illuminated.
3. Attach the +12 VDC supply (do not turn on power yet) to the VSUPP input connector on the MC33816 EVB, making sure to observe the GND and +12 V terminals. The current capability of the +12 V supply should exceed the maximum total current that the number of simultaneously ON loads will require.
4. Attach loads (Injectors) to the INJ1, INJ2, INJ3, and INJ4 output terminals (and optionally FP1 and FP2), as desired.
5. Turn on the +12 V supply. Verify all is working correctly by observing the +5.0 V LED, which should be illuminated.

## 5.4 Running an Example Program

1. Launch the SPIGen program.
2. When the KL25Z is properly connected to the computer, the LED on KL25Z turns blue when SPIGen is running.
3. Load the config file, by clicking on "File" then "Open" and browsing to the KIT33816AESW.spi file located inside the "Injector Demo Files" directory.
4. Go to the "Single Command" page in SPIGen and set the RESETB pin high.
5. Go to the "Micro code" page under "MC33816" and click on the folder icon on the right side of the "Code Ram 1" edit box. Browse to the location of the MC33816\_ch1.cip.bin file, select it, and click on the "Open" button.
6. Click on the folder icon on the right side of the "Code Ram 2" edit box. Browse to the location of the MC33816\_ch2.cip.bin file, select it, and click on the "Open" button.
7. Continue by selecting the Data Ram and Register files located inside the same directory as the microcode files. The file names should be self explanatory. After selecting all the files click "Download All" and wait for a confirmation message. Click on the "Save Filenames" button to save the code and register file configuration.
8. Click the "Enable Flash on CH1 and CH2" button to run the code. At this point both channels should be operational.
9. Go to the "Single command" page and set the DRVEN pin high. This enables all of the pre-drivers and the DC-DC boost converter should also start regulating. Approximately 40 V should be measured on the VBOOST output pin.

## 5.5 Running the Example Batch Files

1. Go to the "Batch commands" page and select the batch file you want to run. There are five choices. "Start1" through "Start4" pulse only one injector (1, 2, 3, or 4). The "Start1-4" batch command pulses all four injectors in sequence.
2. Click on the "Send Continuously" button.
3. Observe the four loads attached to the MC33816 EVB are turning on and off in succession.

There are other demo batch examples that can be run and examined for learning how to use the MC33816 EVB.



# 6 Troubleshooting

**Table 8. Troubleshooting**

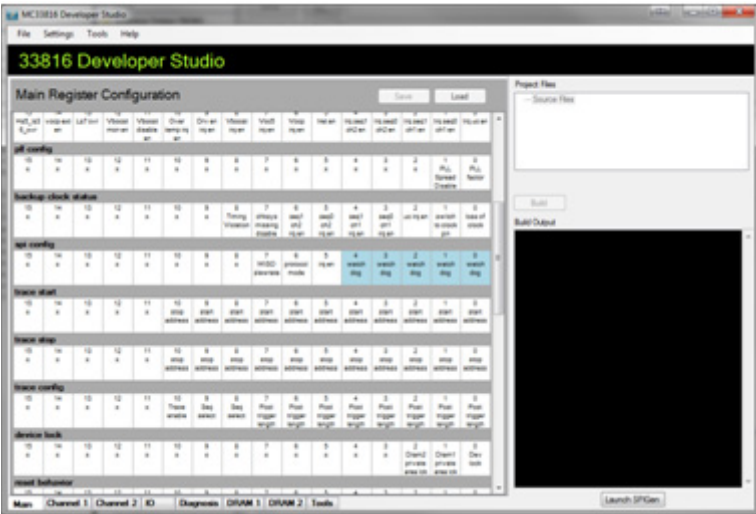
Problem	Possible Solution
Code download fails (all files)	Make sure the RESETB signal on the “Single Command” page is set to High
Download fails after “Main Configuration Register”	Watchdog timeout is set too low. Using the IDE, update the spi_config register in the main config reg so the watchdog value is set to the maximum value (bits 0-4 are set) 
SPIGen does not function on Win8 64-bit	Win8 64-bit is currently not supported. Win8 32-bit is supported. Win7 32-bit and 64-bit are supported
Code downloaded successfully, but outputs are not toggling, and the VBOOST voltage is not correct	Make sure the DRVEN signal on the “Single Command” page is set to High OR After clicking on Download All, make sure to click on Enable Flash on CH1 and CH2 OR Make sure that power supply current limitation is sufficiently high (~4 A)
SPIGen error: “The USB to SPI Device was not found”	Make sure to use at least SPIGEN Rev 7.0. The KL25Z must be connected to the computer using the USB and connected to the KL25Z_USB.

# 7 Schematics

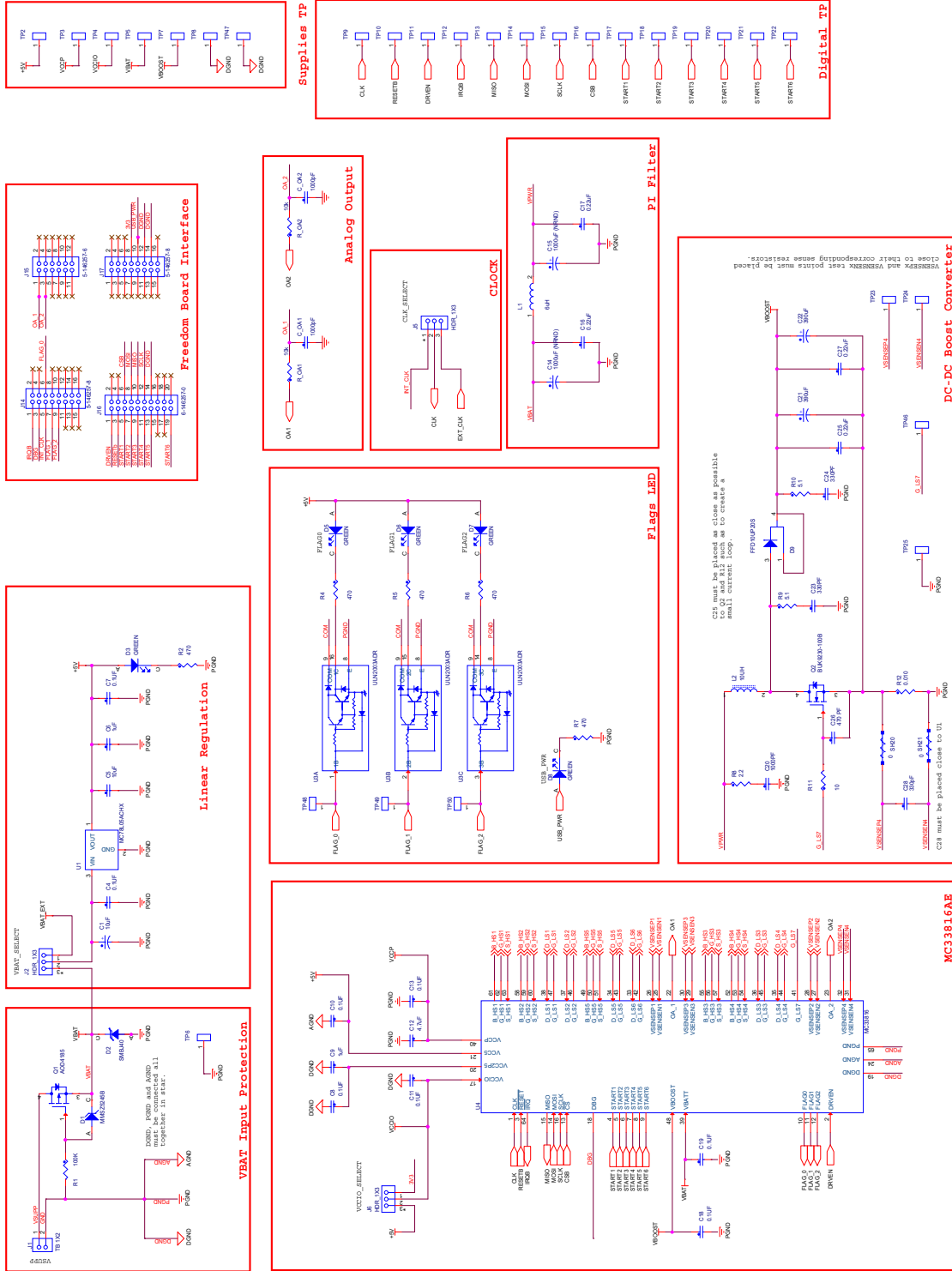

Figure 7. KIT33816FRDMEVM Evaluation Board Schematic Part 1

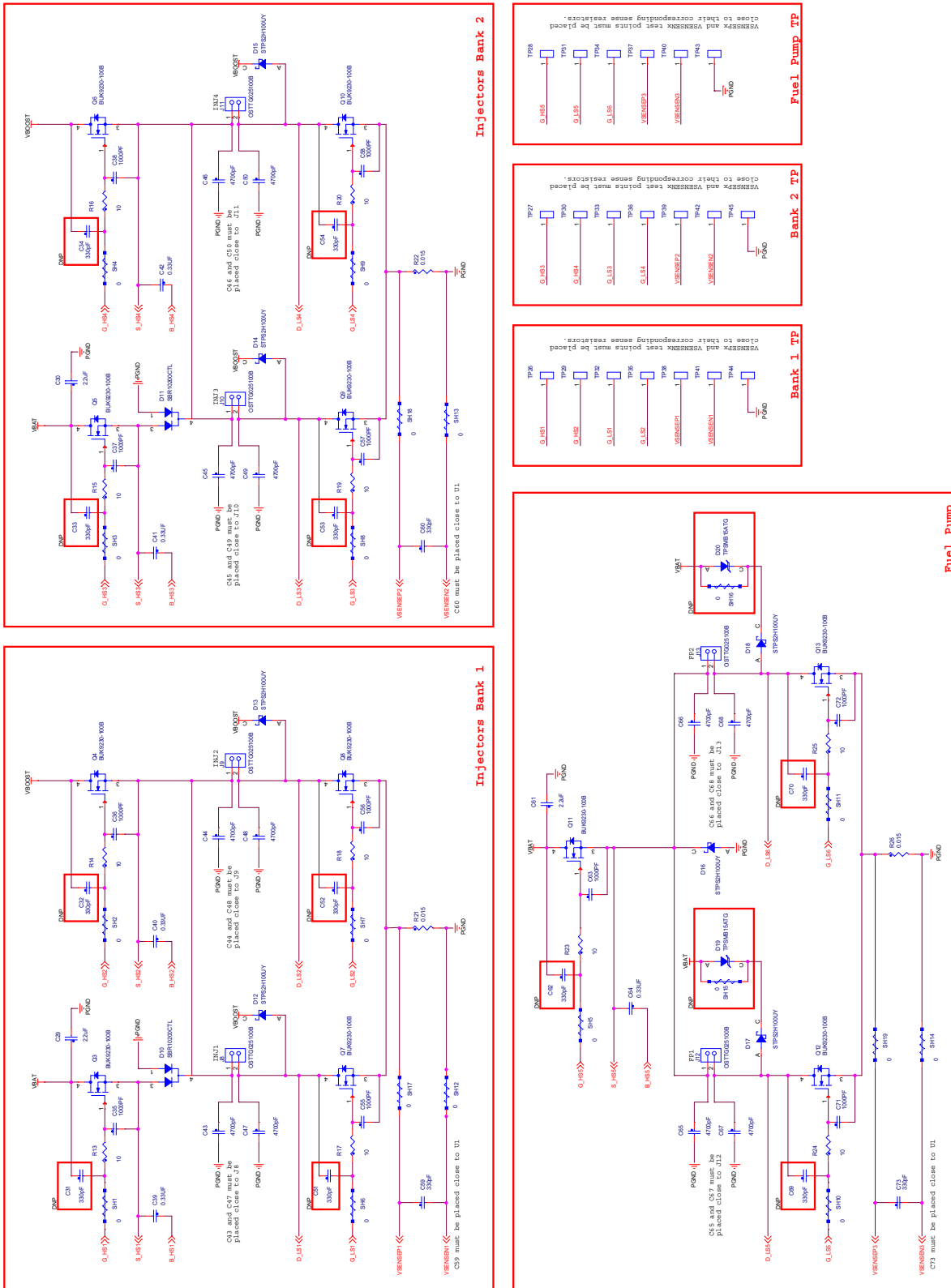
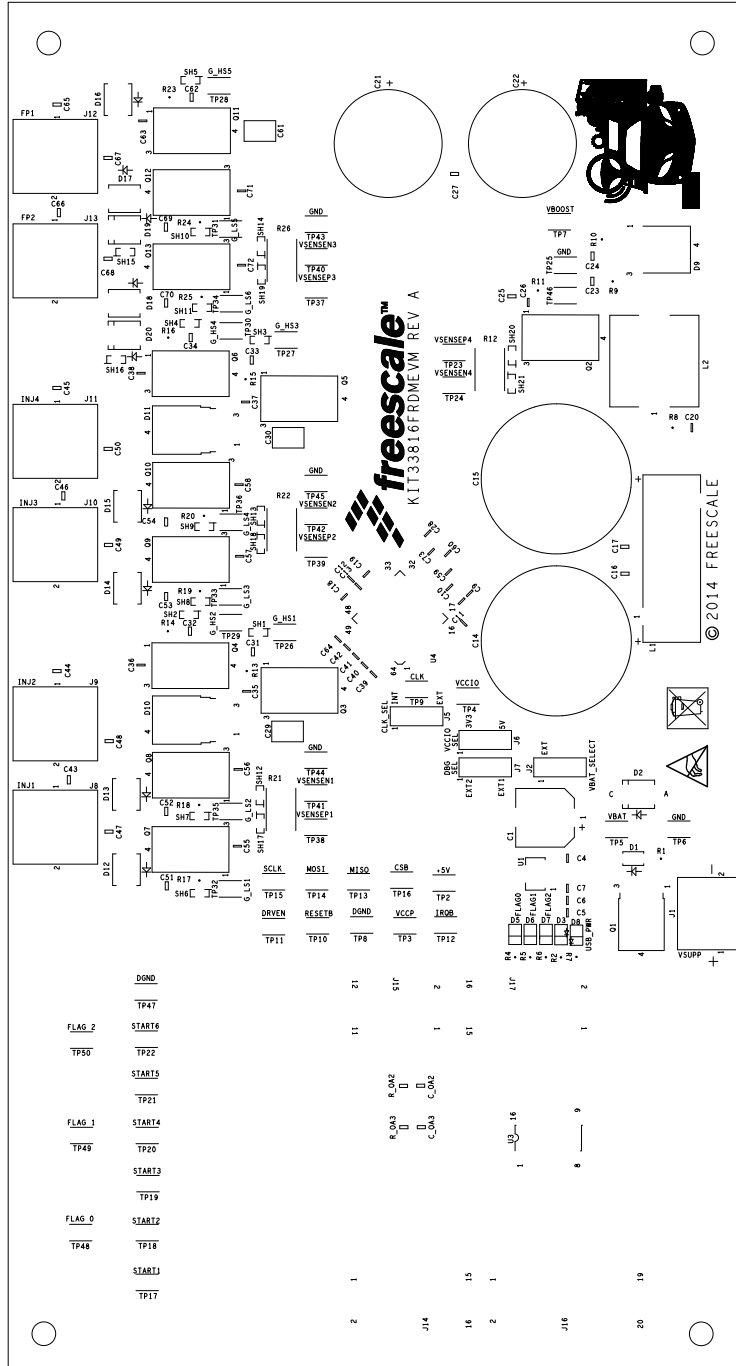

Figure 8. KIT33816FRDMEVM Evaluation Board Schematic Part 2

# 8 Silkscreen

## 8.1 Silkscreen Top



## 9 Bill of Materials

**Table 9. Bill of Materials** <sup>(2)</sup>

Item	Qty	Schematic Label	Value	Description	Part Number	Assy Opt
<b>Freescale Component</b>						
1	1	U4		Freescale IC CTLER AUTOMOTIVE ENGINE/SMART GATE 5.5-72 V LQFP64	MC33816AE	(4)
<b>Active Components</b>						
2	1	U1	MC78L05ACHX	IC VREG 5 V 100 mA 30 V SOT-89	MC78L05ACHX	
3	1	U2	TC1055-3.3 VCT713	IC VREG LDO 3.3 V 100mA 2.7-6 V SOT23-5	TC1055-3.3VCT713	
4	1	U3	ULN2003ADR	IC TRAN ARRAY NPN DARL SEVEN 50 V 0.5 A SOIC16	ULN2003ADR	
<b>Capacitors</b>						
5	1	C1	10 $\mu$ F	CAP ALEL 10 uF 50 V 20% -- SMD	EEETG1H100P	
6	3	C2, C6, C9	1.0 $\mu$ F	CAP CER 1 $\mu$ F 25 V 10% X7R 0'0603	0'0603X105K250SNT	
7	9	C3, C4, C7, C8, C10, C11, C13, C18, C19	0.1 $\mu$ F	CAP CER 0.1 $\mu$ F 50 V 10% X7R 0'0603	GRM188R71H104KA93D	
8	1	C5	10 $\mu$ F	CAP CER 10 $\mu$ F 10 V 20% X5R 0'0603	LMK107BJ106MALTD	
9	1	C12	4.7 $\mu$ F	CAP CER 4.7 $\mu$ F 10 V 10% X5R 0'0603	LMK107BJ475KA-T	
10	2	C14, C15	1000 $\mu$ F (NRND)	CAP ALEL 1000 uF 80 V 20% -- RADIAL (NRND)	ECOS1KP102BA	
11	4	C16, C17, C25, C27	0.22 $\mu$ F	CAP CER 0.22 $\mu$ F 100 V 20% X7S 0'0805	C2012X7S2A224M/SOFT	
12	12	C20, C35-C38, C55-C58, C63, C71, C72	1000 pF	CAP CER 1000 pF 100 V 10% X7R 0'0603	C0'0603C102K1RACTU	
13	2	C21, C22	390 $\mu$ F	CAP ALEL 390 uF 100 V 20% -- RADIAL	UHE2A391MHD	
14	2	C23, C24	330 pF	CAP CER 330 pF 100 V 5% C0G 0'0805	0'08051A331JAT2A	
15	1	C26	470 pF	CAP CER 470 pF 100 V 5% C0G 0'0603	0'0603CG471J101NT	
16	4	C28, C59, C60, C73	330 pF	CAP CER 330 pF 25 V 1% C0G 0'0603	0'06033A331FAT2A	
17	3	C29, C30, C61	2.2 $\mu$ F	CAP CER 2.2 $\mu$ F 100V 10% X7R 1210	GRM32ER72A225KA35L	
18	5	C39-C42, C64	0.33 $\mu$ F	CAP CER 0.33 $\mu$ F 25 V 10% X7R 0'0603	MCCA001173	
19	12	C43-C50, C65-C68	4700 pF	CAP CER 4700 pF 100 V 5% C0G 0'0805	C0'0805C472J1GACTU	
<b>Diodes</b>						
20	1	D1	MMSZ5245B	DIODE ZNR -- 15 V 0.5 W SOD123	MMSZ5245BT1G	
21	1	D2	SMBJ40	DIODE TVS 9.3 A 40 V SMB SMT	SMBJ40A	
22	6	D3-D8	GREEN	LED GRN SGL 30 mA SMT 0'0805	LTST-C171KGKT	
23	1	D9	FFD10UP20S	DIODE SW UF 10 A 200 V TO252	FFD10UP20S	

**Table 9. Bill of Materials <sup>(2)</sup> (continued)**

24	2	D10, D11	SBR10200CTL	DIODE DUAL CC RECT SW 10 A 200 V DPAK	SBR10200CTL-13	
25	7	D12-D18	STPS2H100UY	DIODE SCH RECT 2 A 100 V AEC-Q101 SMB	STPS2H100UY	

**Connectors and Jumpers**

26	1	J1	TB 1X2	CON 1X2 TB TH 5MM 12.9 MM SN 150L	OSTTA020161	
27	4	J2, J5-J6	HDR_1X3	HDR 1X3 TH 100 MIL SP 319H AU 130L	961103-6404-AR	
28	1	J7	HDR_1X3	HDR 1X3 TH 100 MIL SP 319H AU 130L	961103-6404-AR	(3)
29	2	J14,J17	5-146257-8	CON 2X8 PLUG 2.54 MM CTR 328H AU 120L	5-146257-8	
30	1	J16	6-146257-0	CON 2X6 PLUG 2.54 MM CTR 328H AU 120L	6-146257-0	
31	1	J15	5-146257-6	CON 2X10 PLUG 2.54 MM CTR 328H AU 120L	5-146257-6	
32	6	J8-J13	OSTTG025100B	CON 1X2 TB TH 5.08 MM 504H -- 177L	OSTTG025100B	

**Inductors**

33	1	L1	6.0 $\mu$ H	IND ROD CHK 6 $\mu$ H@10 kHz 10 A 25% TH	744710610	
34	1	L2	10 $\mu$ H	IND PWR 10 $\mu$ H@100 kHz 16 A 20% SMT	SRP1250-100M	

**Transistors**

35	1	Q1	AOD4185	TRAN PMOS PWR 40 A 40 V TO252	AOD4185	
36	12	Q2-Q13	BUK9230-100B	TRAN NMOS PWR SW 47 A 100 V DPAK	BUK9230-100B,118	

**Resistors**

37	1	R1	100 K	RES MF 100K 1/10 W 5% 0'0603	CR0'0603-JW-104ELF	
38	5	R2, R4-R7	470	RES MF 470 Ohm 1/10 W 5% 0'0603	CR0'0603-10W-471JT	
39	1	R3	180	RES MF 180 Ohm 1/10 W 5% 0'0603	RK73B1JTTD181J	
40	1	R8	2.2	RES MF 2.2 Ohm 1/10 W 5% 0'0603	ERJ3GEYJ2R2V	
41	2	R9, R10	5.1	RES MF 5.1 Ohm 1/10 W 5% 0'0603	RK73B1JTTD5R1J	
42	12	R11, R13-R20, R23-R25	10	RES MF 10 Ohm 1/10 W 5% AEC-Q200 0'0603	CRCW0'060310R0JNEA	
43	1	R12	0.010	RES METAL STRIP 0.01 Ohm 1 W 1% 2512	WSK2512R0100FEA	
44	3	R21, R22, R26	0.015	RES MF 0.015 Ohm 1 W 1% AEC-Q200 2512	WSK2512R0150FEA	

**Test Points**

45	48	TP1-TP48	3.65x2.05MM	TEST POINT 3.65x2.05 MM SMT	S1751-46R	
----	----	----------	-------------	-----------------------------	-----------	--

**Notes**

2. Freescale does not assume liability, endorse, or warrant components from external manufacturers are referenced in circuit drawings or tables. While Freescale offers component recommendations in this configuration, it is the customer's responsibility to validate their application.
3. Do not populate.
4. **Critical components.** For critical components, it is vital to use the manufacturer listed.

## 10 References

Following are URLs where you can obtain information on related Freescale products and application solutions:

Freescale.com Support Pages	Description	URL
KIT33816FRDMEVM	Tool Summary Page	<a href="http://www.freescale.com/webapp/sps/site/prod_summary.jsp?code=KIT33816FRDMEVM">http://www.freescale.com/webapp/sps/site/prod_summary.jsp?code=KIT33816FRDMEVM</a>
MC33816	Product Summary Page	<a href="http://www.freescale.com/webapp/sps/site/prod_summary.jsp?code=MC33816">http://www.freescale.com/webapp/sps/site/prod_summary.jsp?code=MC33816</a>
FRDM-KL25Z	Tool Summary Page	<a href="http://www.freescale.com/webapp/sps/site/prod_summary.jsp?code=FRDM-KL25Z">http://www.freescale.com/webapp/sps/site/prod_summary.jsp?code=FRDM-KL25Z</a>
SPIGen	Tool Summary Page	<a href="http://www.freescale.com/webapp/sps/site/prod_summary.jsp?&amp;code=SPIGEN">http://www.freescale.com/webapp/sps/site/prod_summary.jsp?&amp;code=SPIGEN</a>
Analog Home Page		<a href="http://www.freescale.com/analog">http://www.freescale.com/analog</a>
Automotive Home Page		<a href="http://www.freescale.com/automotive">http://www.freescale.com/automotive</a>
AN4849	Application Note	<a href="http://www.freescale.com/files/analog/doc/app_note/AN4849.pdf">http://www.freescale.com/files/analog/doc/app_note/AN4849.pdf</a>
AN4954	Application Note	<a href="http://www.freescale.com/files/analog/doc/app_note/AN4954.pdf">http://www.freescale.com/files/analog/doc/app_note/AN4954.pdf</a>

### 10.1 Support

Visit [www.freescale.com/support](http://www.freescale.com/support) for a list of phone numbers within your region.

### 10.2 Warranty

Visit [www.freescale.com/warranty](http://www.freescale.com/warranty) for a list of phone numbers within your region.

## 11 Revision History

Revision	Date	Description of Changes
1.0	10/2014	• Initial Release
2.0	11/2014	• Updated step 1 in <a href="#">Section 3.3.4</a>



**How to Reach Us:**

**Home Page:**  
[freescale.com](http://freescale.com)

**Web Support:**  
[freescale.com/support](http://freescale.com/support)

Information in this document is provided solely to enable system and software implementers to use Freescale products. There are no express or implied copyright licenses granted hereunder to design or fabricate any integrated circuits based on the information in this document.

Freescale reserves the right to make changes without further notice to any products herein. Freescale makes no warranty, representation, or guarantee regarding the suitability of its products for any particular purpose, nor does Freescale assume any liability arising out of the application or use of any product or circuit, and specifically disclaims any and all liability, including without limitation consequential or incidental damages. "Typical" parameters that may be provided in Freescale data sheets and/or specifications can and do vary in different applications, and actual performance may vary over time. All operating parameters, including "typicals," must be validated for each customer application by customer's technical experts. Freescale does not convey any license under its patent rights nor the rights of others. Freescale sells products pursuant to standard terms and conditions of sale, which can be found at the following address: [freescale.com/SalesTermsandConditions](http://freescale.com/SalesTermsandConditions).

Freescale and the Freescale logo are trademarks of Freescale Semiconductor, Inc., Reg. U.S. Pat. & Tm. Off. SMARTMOS is a trademark of Freescale Semiconductor, Inc. All other product or service names are the property of their respective owners.

© 2014 Freescale Semiconductor, Inc.

Document Number: KT33816FRDMUG  
Rev. 2.0  
11/2014