

Applications

- Low voltage, high density systems with Intermediate Bus Architectures (IBA)
- Point-of-load regulators for high performance DSP, FPGA, ASIC, and microprocessors
- Desktops, servers, and portable computing
- Broadband, networking, optical, and communications systems

Benefits

- One part that covers many applications
- Reduces board space, system cost and complexity, and time to market

Description

Power-One's point-of-load converters are recommended for use with regulated bus converters in an Intermediate Bus Architecture (IBA). The YV09T60 non-isolated DC-DC point of load (POL) converter delivers up to 60A of output current, in an industry-standard single-in-line (SIP) through-hole package. The YV09T60 POL converter is an ideal choice for Intermediate Bus Architectures where point of load conversion is a requirement. Operating from a 5-13.8V input the POL converter provides an extremely tightly regulated programmable output voltage of 0.6V to 1.98V. The POL converters offer exceptional thermal performance, even in high temperature environments with minimal airflow. This performance is accomplished through the use of advanced circuit solutions, packaging and processing techniques. The resulting design possesses ultra-high efficiency, excellent thermal management, and a slim body profile that minimizes impedance to system airflow, thus enhancing cooling for both upstream and downstream devices. The use of automation for assembly, coupled with advanced power electronics and thermal design, results in a product with extremely high reliability.

Features

- RoHS lead free and lead-solder-exempt products are available
- High efficiency multiphase synchronous buck topology
- Low noise fixed frequency operation
- Wide input voltage range: 5V–13.8V
- High continuous output current: 60A
- Programmable output voltage range: 0.6V–1.98V
- Overcurrent, output overvoltage, and overtemperature protections with automatic restart
- Remote differential output voltage sense
- Power Good signal
- Enable input
- Start up into prebiased load
- No minimum load requirements
- High MTBF of 40.4Mhrs
- Industry standard size through-hole single-in-line package and pinout
 - 2.58"x0.628" (65.5 x 16mm)
- Low height of 1.25" (31.8mm)
- Wide operating temperature range: 0 to 70°C
- UL94 V-0 flammability rating
- UL60950, CSA C22.2 No. 60950-00, and TUV EN60950-1:2001

1. Ordering Information

Y	V	09	T	60	-	0	z
Product Family	Profile	Input Voltage	PCB Mounting	Output Current	Dash	ON/OFF Logic	RoHS compliance
POL Converter	Vertical	5V to 13.8V	Through-hole	60A		Positive Logic	RoHS compliant with Pb solder exemption ¹

¹ The solder exemption refers to all the restricted materials except lead in solder. These materials are Cadmium (Cd), Hexavalent chromium (Cr6+), Mercury (Hg), Polybrominated biphenyls (PBB), Polybrominated diphenylethers (PBDE), and Lead (Pb) used anywhere except in solder.

Example: **YV09T60-0G**: YV09T60 POL converter with positive ON/OFF logic, and lead-free solder. Refer to Figure 1 for label marking information.

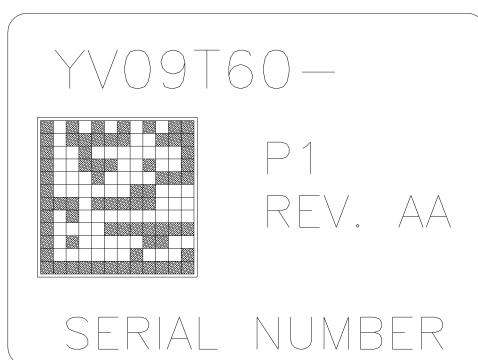

Figure 1. Label Drawing

2. Absolute Maximum Ratings

Stresses in excess of the absolute maximum ratings may cause performance degradation, adversely affect long-term reliability, and cause permanent damage to the converter.

Parameter	Conditions/Description	Min	Max	Units
Input Voltage	Continuous	-0.3	15	VDC
Ambient Temperature Range	Operating	0	70	°C
Storage Temperature (Ts)		-55	125	°C

3. Environmental and Mechanical Specifications

Parameter	Conditions/Description	Min	Nom	Max	Units
Weight				36	grams
MTBF	Calculated Per Telcordia Technologies SR-332	40.4			MHrs
Lead Plating		100% Matte Tin			

4. Electrical Specifications

Specifications apply at the input voltage from 5V to 13.8V, output load from 0 to 60A, output voltage from 0.6V to 1.98V, a 470 μ F output capacitor, and ambient temperature from 0°C to 70°C unless otherwise noted.

4.1 Input Specifications

Parameter	Conditions/Description	Min	Nom	Max	Units
Input voltage (V_{IN})	$V_{OUT} \leq 0.55 * V_{IN}$	5	12	13.8	VDC
Undervoltage Lockout Turn On Threshold	Input Voltage Ramping Up	4.25	4.4	4.6	VDC
Undervoltage Lockout Turn Off Threshold	Input Voltage Ramping Down	3.75	3.9	4.1	VDC
Input Current	$V_{IN}=5V, V_{OUT}=1.5V, I_{OUT}=I_{OUT\ MAX}$			20	ADC
Standby Input Current	$V_{IN}=12V$, POL is disabled via ON/OFF		20		mADC
Input Reflected Ripple Current Peak-to-Peak	$BW=5MHz$ to $20MHz$, $L_{SOURCE}=1\mu H$, See Figure for setup		50		mA

4.2 Output Specifications

Parameter	Conditions/Description	Min	Nom	Max	Units
Output Voltage Range (V_{OUT})	YV09T60-0 Programmable with a resistor between TRIM+ and TRIM- pins	0.6		1.98	VDC
Output Voltage Setpoint Accuracy, $V_{OUT} \geq 1V$	$V_{IN}=12V, I_{OUT}=I_{OUT\ MAX}$, 0.1% trim resistor, room temperature	-0.8		0.8	% V_{OUT}
Output Voltage Setpoint Accuracy, $V_{OUT} < 1V$	$V_{IN}=12V, I_{OUT}=I_{OUT\ MAX}$, 0.1% trim resistor, room temperature	-7		7	mVDC
Line Regulation, $V_{OUT} \geq 2.5V$	$V_{IN\ MIN}$ to $V_{IN\ MAX}$			0.3	% V_{OUT}
Load Regulation, $V_{OUT} \geq 2.5V$	0 to $I_{OUT\ MAX}$			0.3	% V_{OUT}
Line Regulation, $V_{OUT} < 2.5V$	$V_{IN\ MIN}$ to $V_{IN\ MAX}$			9	mVDC
Load Regulation, $V_{OUT} < 2.5V$	0 to $I_{OUT\ MAX}$			12	mVDC
Output Voltage Regulation	Over operating input voltage, resistive load, and temperature conditions until the end of life	-1.1		1.1	% V_{OUT}
Output Voltage Peak-to-Peak Ripple and Noise, $BW=20MHz$	$V_{IN}=12V, V_{OUT}=0.6V$		10		mV
	$V_{IN}=12V, V_{OUT}=1.5V$		10		mV
Dynamic Regulation Peak Deviation Settling Time	0 - 50% load step, Slew rate 10A/ μ s, $V_{IN}=12V, V_{OUT}=1.98V$ to 10% of peak deviation		350		mV
			25		μ s
Efficiency $V_{IN}=12V$ Full Load Room temperature	$V_{OUT}=0.6V$		77.6		%
	$V_{OUT}=0.8V$		82.5		%
	$V_{OUT}=1.0V$		85.2		%
	$V_{OUT}=1.2V$		87		%
	$V_{OUT}=1.5V$		89		%
	$V_{OUT}=1.8V$		90.5		%

Parameter	Conditions/Description	Min	Nom	Max	Units
Output Current (I_{OUT})	$V_{IN\ MIN}$ to $V_{IN\ MAX}$	0		60	ADC
Turn-On Delay Time ¹ POL is Enabled	ON/OFF pin is floating From $V_{IN}=V_{IN\ MIN}$ to $V_{OUT}=0.1*V_{OUT.SET}$		1	2	ms
Turn-On Delay Time ¹ POL is Disabled	$V_{IN}=12V$ From ON/OFF pin changing its state from low to high until $V_{OUT}=0.1*V_{OUT.SET}$		0.5	1	ms
Rise Time ¹ $C_{OUT}=0\ \mu F$, Resistive Load	From $V_{OUT}=0.1*V_{OUT.SET}$ to $V_{OUT}=0.9*V_{OUT.SET}$		2	3	ms
Admissible Output Capacitance	$I_{OUT}=I_{OUT\ MAX}$, Resistive load, $ESR>3m\Omega$			5,000	μF
Switching Frequency	3 phases combined		945		kHz
Duty Cycle				55	%

¹ Total start-up time is the sum of the turn-on delay time and the rise time

4.3 Protection Specifications

Parameter	Conditions/Description	Min	Nom	Max	Units
Output Overcurrent Protection					
Type		Auto-Restart			
Inception Point		105	130	150	% I_{OUT}
Output Short Circuit Current (RMS value)	$R_{OUT}<0.01\Omega$		6		A
Output Overvoltage Protection					
Type		Auto-Restart			
Threshold	$I_{OUT}=I_{OUT\ MAX}$, room temperature	120	125	130	% $V_{O.SET}$
Overtemperature Protection					
Type		Auto-Restart			
Turn Off Threshold	Temperature is increasing		125		$^{\circ}C$
Turn On Threshold	Temperature is decreasing after the POL was shut down by OTP		115		$^{\circ}C$
Power Good Signal (PwrGood pin)					
Logic	V_{OUT} is inside the PG window V_{OUT} is outside the PG window		High Low		N/A
Low Output Voltage	$I_{SINK}=4mA$			0.5	VDC
High Output Voltage	External pull-up	2.4		5.25	VDC

4.4 Feature Specifications

Parameter	Conditions/Description	Min	Nom	Max	Units
Enable (ON/OFF pin)					
ON/OFF Logic		Positive (enables the output when ON/OFF pin is open)			N/A
ON/OFF High Input Voltage	POL is ON	2.4		V _{IN.MAX}	VDC
ON/OFF High Input Current	POL is ON			0.5	mADC
ON/OFF Low Input Voltage	POL is OFF	-0.3		1.2	VDC
ON/OFF Low Input Current	POL is OFF			0.12	mADC
Remote Voltage Sense (+VS and -VS pins)					
Voltage Drop Compensation ¹				500	mV

¹ The output voltage measured directly between Vout and GND pins shall never exceed 3.63V

5. Typical Performance Characteristics

5.1 Efficiency Curves

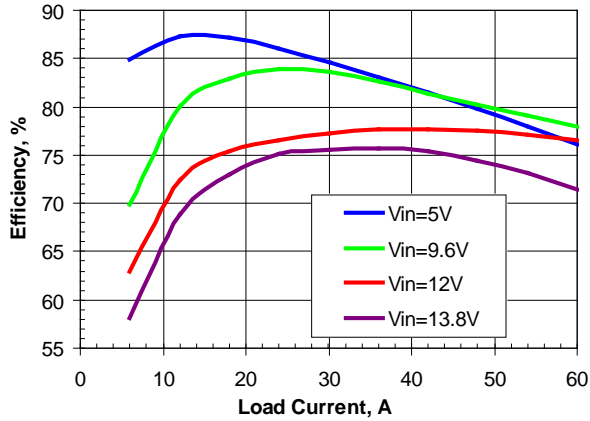

Figure 2. Efficiency vs. Load. Vout=0.6V

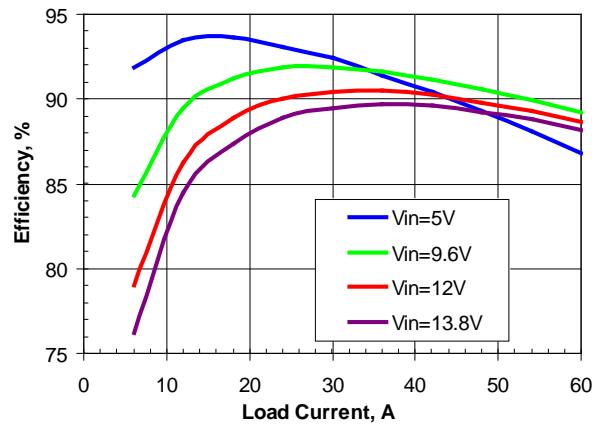

Figure 4. Efficiency vs. Load. Vout=1.5V

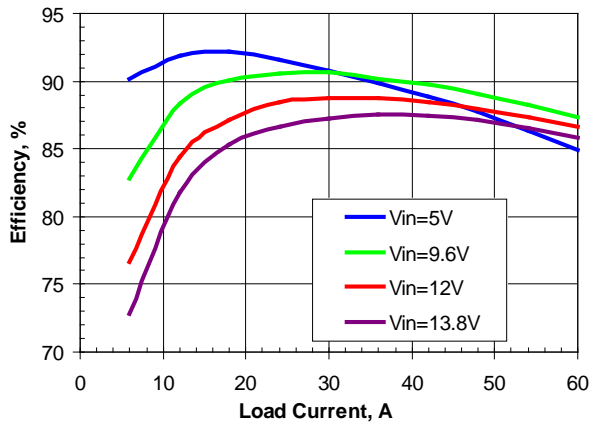

Figure 3. Efficiency vs. Load. Vout=1.2V

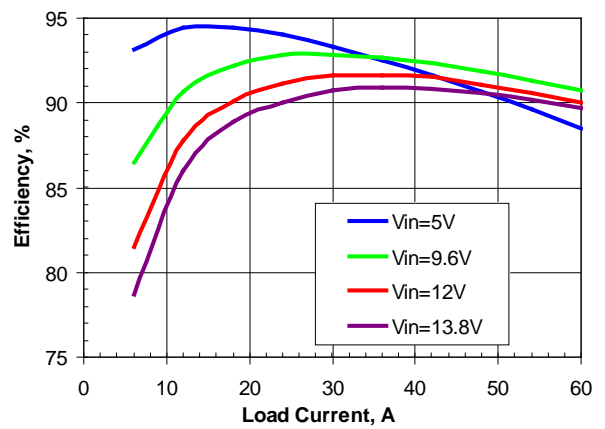

Figure 5. Efficiency vs. Load. Vout=1.8V

5.2 Power Dissipation Curves

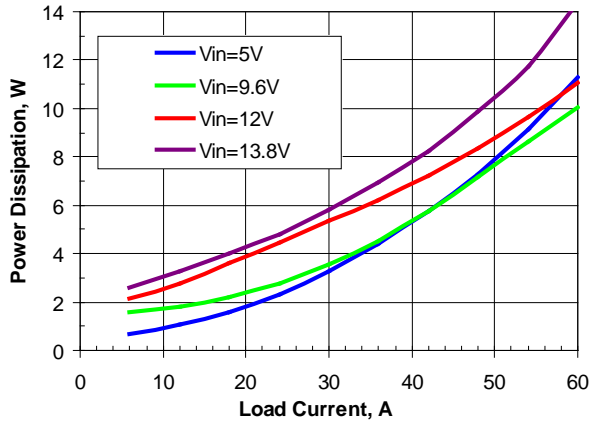

Figure 6. Power Dissipation vs. Load. Vout=0.6V

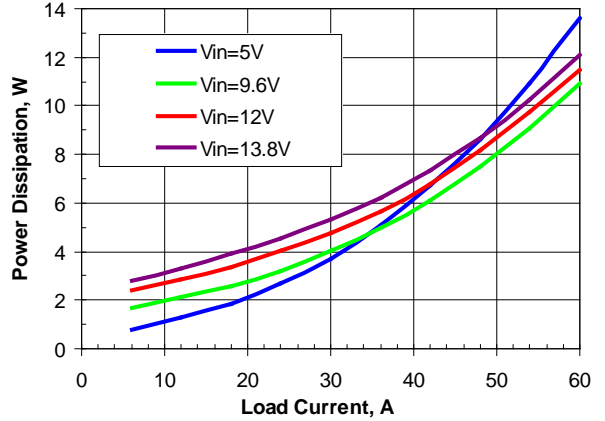

Figure 8. Power Dissipation vs. Load. Vout=1.5V

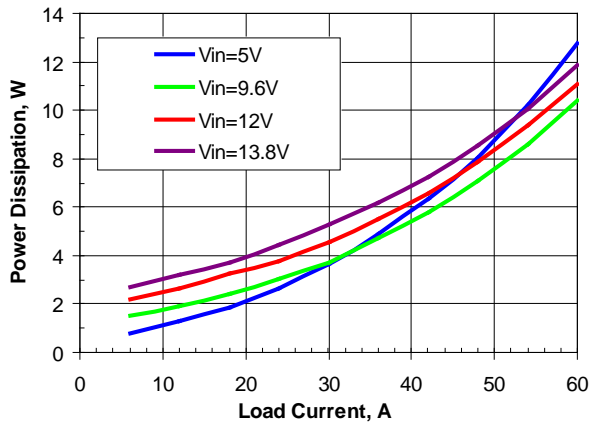

Figure 7. Power Dissipation vs. Load. Vout=1.2V

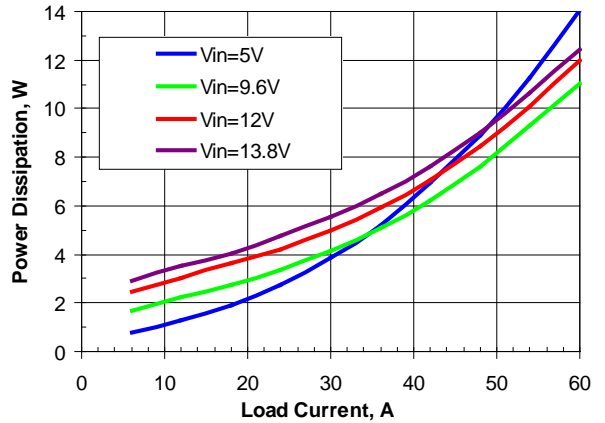

Figure 9. Power Dissipation vs. Load. Vout=1.8V

5.3 Turn-On Characteristics

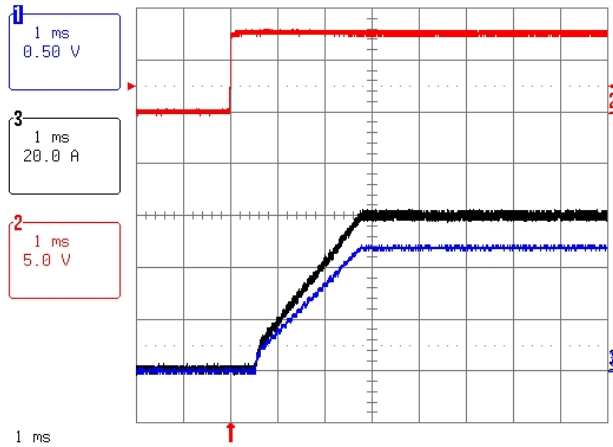

Figure 10. Typical Start-Up Using Remote On/Off
($V_o = 1.2\text{Vdc}$, $I_o=60\text{A}$). Ch1 – Vout, Ch2 – On/Off, Ch3 - Iout

5.4 Transient Response

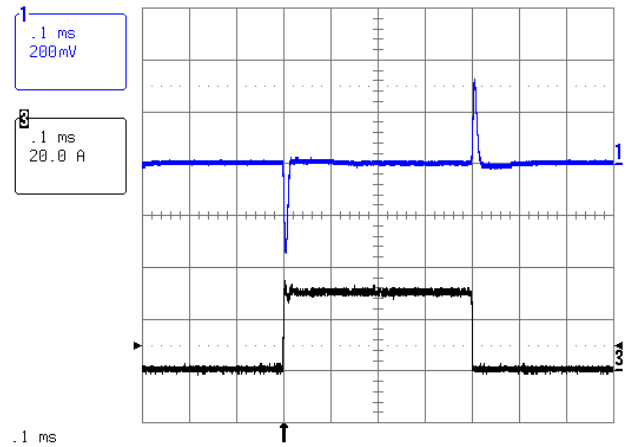

Figure 12. Transient Response to Dynamic Load Change
from 0% to 50% of full load ($V_{in}=12\text{V}$, $V_o=1.5\text{V}$).
Ch1 – Vout, Ch3 – Iin

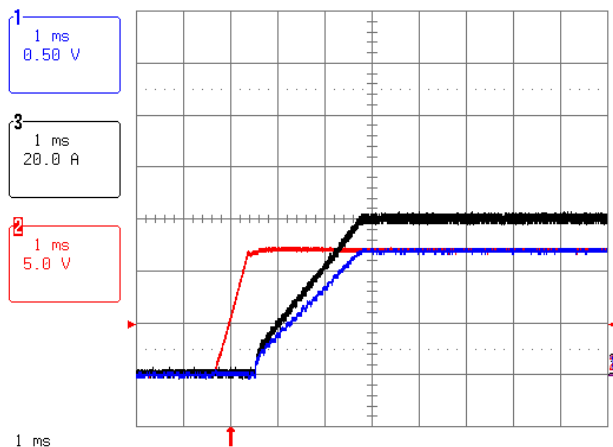

Figure 11. Typical Start-Up with application of V_{in}
($V_o = 1.2\text{Vdc}$, $I_o = 60\text{A}$). Ch1 – Vout, Ch2 – V_{in} , Ch3 - Iout

5.5 Derating Curves

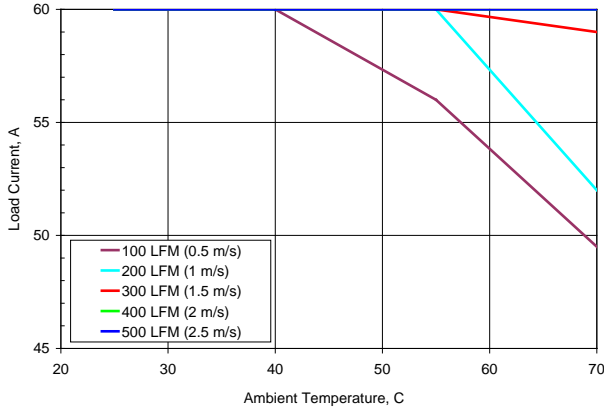

Figure 13. Derating Output Current versus Local Ambient Temperature and Airflow (Vin=12.0V, Vo=0.6V).

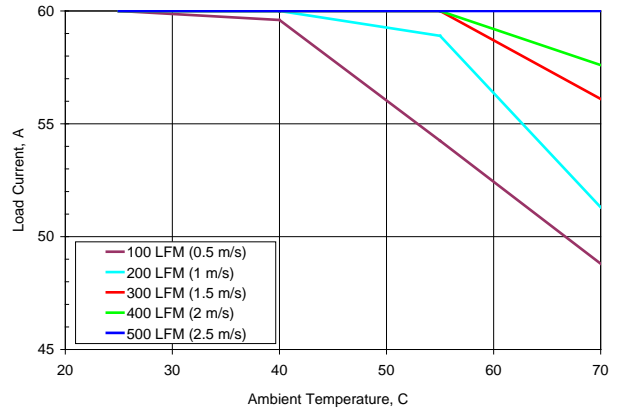

Figure 15. Derating Output Current versus Local Ambient Temperature and Airflow (Vin=12.0V, Vo=1.5V).

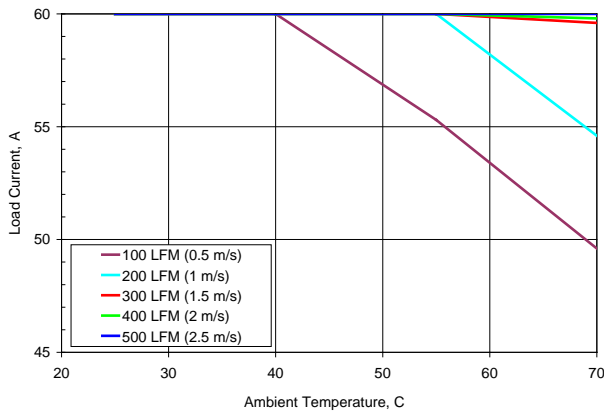

Figure 14. Derating Output Current versus Local Ambient Temperature and Airflow (Vin=12.0V, Vo=1.2V).

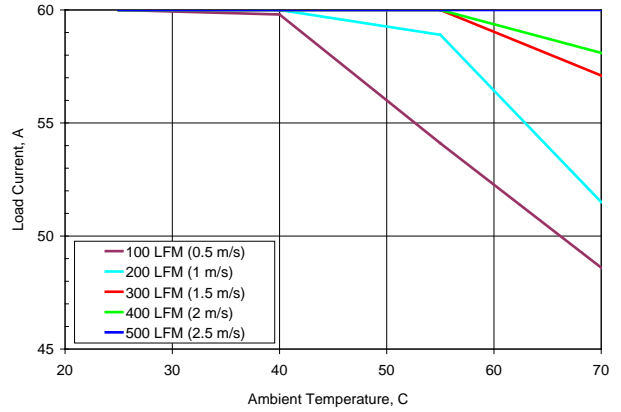

Figure 16. Derating Output Current versus Local Ambient Temperature and Airflow (Vin=12.0V, Vo=1.8V).

6. Application Information

6.1 Input and Output Impedance

The POL converter should be connected to the DC power source via low impedance. In many applications, the inductance associated with the distribution from the power source to the input of the converter can affect the stability of the converter. Internally, the converter includes 110µF (low ESR ceramics) of input capacitance which eliminates the need for external input capacitance. However, if the distribution of the input voltage to the POL converter contains high inductance, it is recommended to add a 150µF decoupling capacitor placed as close as possible to the converter input pins. A low-ESR tantalum or POS capacitor connected across the input pins help ensuring stability of the POL converter and reduce input ripple voltage.

A 470µF POS, tantalum, or ceramic output capacitor is recommended to improve output ripple and dynamic response.

It is important to keep low resistance and low inductance of PCB traces for connecting load to the output pins of the converter in order to maintain good load regulation.

6.2 Output Voltage Programming

The output voltage can be programmed from 0.6V to 1.98V by connecting an external resistor R_{TRIM} between Trim+ pin (Pin 1) and Trim- pin (Pin 5), as shown in Figure .

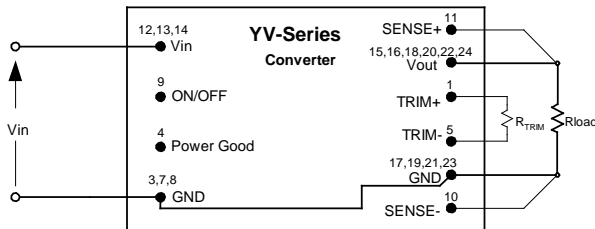

Figure 17. Programming Output Voltage With A Resistor

The trim resistor R_{TRIM} for a desired output voltage can be calculated using the following equation:

$$R_{TRIM} = \frac{1.2}{V_{OUT} - 0.6}, \text{ k}\Omega$$

where:

R_{TRIM} = Required value of trim resistor in kΩ

V_{OUT} = Desired (trimmed) value of output voltage V

If the R_{TRIM} is not used and the Sense+ and Sense- pins are shorted to Vout and GND respectively, the output voltage of the POL converter will be 0.6V. No capacitor is allowed between Trim+ and Trim- pins.

Note that the trim resistor tolerance directly affects the output voltage accuracy. It is recommended to use ±0.1% trim resistors to meet the output voltage setpoint accuracy specified in p. 4.2.

Table 1. Trim Resistor Values

V_{OUT} , V	Calculated R_{TRIM} , kΩ	Standard Value of 0.1% Resistor, kΩ
0.6	Open	Open
1.0	3.0	3.01
1.2	2.0	2.0
1.5	1.333	1.33
1.8	1.0	1.0

6.3 ON/OFF (Pin 9)

The ON/OFF pin is used to turn the POL converter ON or OFF remotely by a signal from a system controller. For positive logic, the POL converter is ON when the ON/OFF pin is at a logic high (2.4V min) or left open. The POL converter is OFF when the ON/OFF pin is at a logic low (1.2V max) or connected to GND.

The typical connections are shown in Figure .

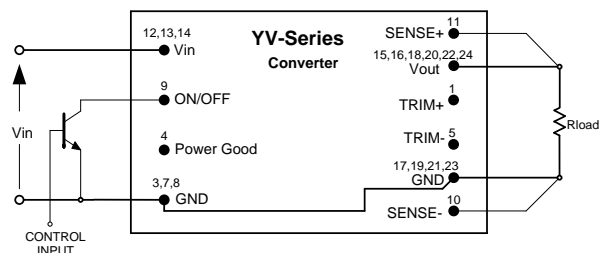

Figure 18. Circuit Configuration For ON/OFF Function

The ON/OFF pin is referenced to ground and typically has 50kΩ input impedance. It has an internal 50kΩ pull-up to 5V supply. It is recommended to control the ON/OFF pin with an open collector transistor or similar device.

6.4 Remote Sense (Pins 10 and 11)

The remote sense feature compensates for the voltage drop between the output pins of the POL converter and the load. The Sense- (Pin 10) and Sense+ (Pin 11) pins should be connected at the load or at the point where regulation is required (refer to Figure 19).

If remote sensing is not required, the Sense pins must be connected to the Vout and GND pins directly at the output of the POL converter.

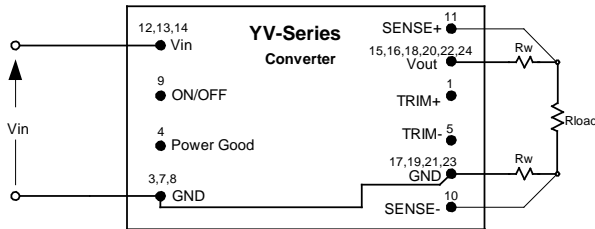

Figure 19. Remote Sense Circuit Configuration

Because the sense leads carry minimal current, large traces on the end-user board are not required. The voltage sense traces should be located close to a ground plane to minimize system noise.

When using remote sense, the output voltage at the converter can be increased by up to 0.5V in order to maintain the required voltage at the load. However, the maximum output voltage measured directly between the Vout and GND pins shall not exceed 1.98V. In addition it is the user's responsibility to ensure the POL converter's actual output power always remains at or below the maximum allowable output power obtained from the derating curves.

6.5 Protections

6.5.1 Power Good

Power Good pin (Pin 4) is an open drain output, capable of sinking up to 4mA. The Power Good pin is high when the output voltage is within the regulation band. The Power Good pin is at logic low during start-up, undervoltage, overvoltage or overcurrent conditions, or when the POL converter is disabled via the ON/OFF signal.

6.5.2 Input Undervoltage Lockout

The POL converter will shut down when the input voltage drops below a predetermined voltage. It will start automatically when the input voltage exceeds the specified threshold.

6.5.3 Output Overcurrent Protection

The POL converter is protected against overcurrent and short circuit conditions. Upon sensing an overcurrent condition, the POL converter will enter hiccup mode of operation. Once the overload or short circuit condition is removed, the POL converter will automatically restart and Vout will return to its nominal value.

6.5.4 Output Overvoltage Protection

The POL converter is protected against overvoltage on the output. If the output voltage is higher than 125% of its nominal value set by the R_{TRIM} , the high side MOSFETs will be immediately turned off and the low side MOSFETs will be turned on. The POL converter will remain in the state until the output voltage reduces below 115% of its nominal value. At that point the POL converter will automatically restart.

7. Characterization

7.1 Ripple and Noise

The output voltage ripple and input reflected ripple current waveforms are measured using the test setup shown in Figure 20.

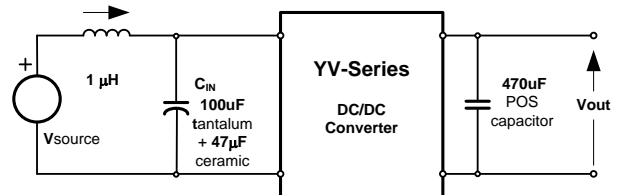

Figure 20. Test Setup For Measuring Input Reflected-Ripple Current And Output Voltage Ripple

8. Safety

The YV09T60 POL converters **do not provide isolation** from input to output. The input devices powering YV09T60 must provide relevant isolation requirements according to all IEC60950 based standards. Nevertheless, if the system using the converter needs to receive safety agency approval, certain rules must be followed in the design of the system. In particular, all of the creepage and clearance requirements of the end-use safety requirements must be observed. These requirements are included in UL60950 - CSA60950-00 and EN60950, although specific applications may have other or additional requirements.

The YV09T60 POL converters have no internal fuse. If required, the external fuse needs to be provided to protect the converter from catastrophic failure. Refer to the "Input Fuse Selection for DC/DC converters" application note on www.power-one.com for proper selection of the input fuse. Both input traces and the chassis ground trace (if applicable) must be capable of conducting a current of 1.5 times the value of the fuse without opening.

To comply with safety agencies' requirements, a recognized fuse must be used in series with the input line. The fuse must not be placed in the grounded

input line. Abnormal and component failure tests were conducted with the POL input protected by a fast-acting 45A, 32V fuse. If a fuse rated greater than 45A is used, additional testing may be required.

The maximum DC voltage between any two pins is V_{in} under all operating conditions. In order for the output of the YV09T60 POL converter to be considered as SELV (Safety Extra Low Voltage), according to all IEC60950 based standards, the input to the POL needs to be supplied by an isolated secondary source providing a SELV also.

9. Pin Assignments and Description

Pin Name	Pin Number	Pin Type	Buffer Type	Pin Description	Notes
Trim+	1	I	A	Output Voltage Trim	Connect a high accuracy resistor between Trim+ and Trim- pins to set the output voltage
	2			No Pin	
PwrGood	4	I/O	PU	Power Good	Open drain pin indicating status of the output voltage
Trim-	5	I/O	A	Output Voltage Trim	Connect a high accuracy resistor between Trim+ and Trim- pins to set the output voltage
NC	6			Not Used	Leave floating
ON/OFF	9	I	PU	Enable	Pull high or leave floating to turn ON the POL
Sense-	10	I	A	Negative Voltage Sense	Connect to the negative point close to the load
Sense+	11	I	A	Positive Voltage Sense	Connect to the positive point close to the load
Vout	15, 16, 18, 20, 22,24	P		Output Voltage	
GND	3, 7, 8, 17, 19, 21, 23	P		Power Ground	
Vin	12, 13, 14	P		Input Voltage	

Legend: I=input, O=output, I/O=input/output, P=power, A=analog, PU=internal pull-up

10. Mechanical Drawings

All Dimensions are in inches

Tolerances: X.XX: ±0.02" X.XXX: ±0.01"

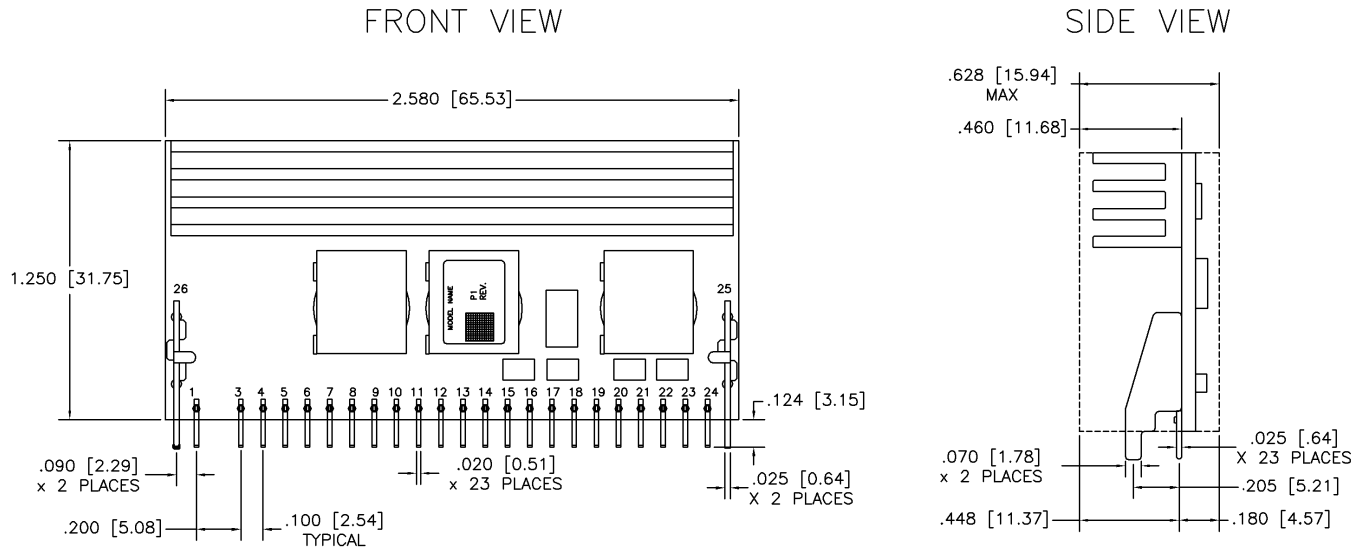

Figure 11. Mechanical Drawing

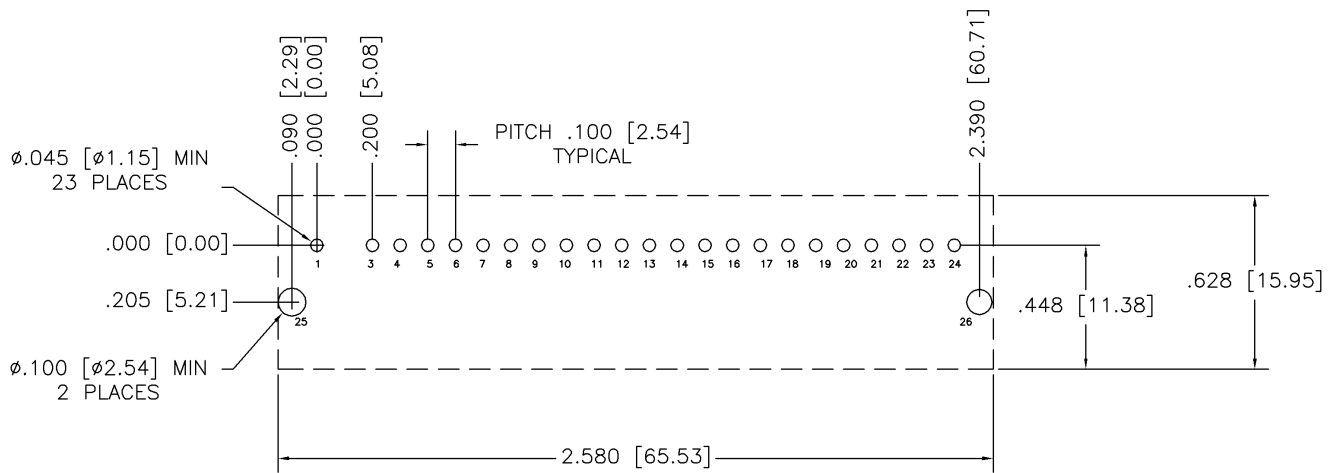

Figure 12. Recommended Footprint – Top View

Notes:

1. NUCLEAR AND MEDICAL APPLICATIONS - Power-One products are not designed, intended for use in, or authorized for use as critical components in life support systems, equipment used in hazardous environments, or nuclear control systems without the express written consent of the respective divisional president of Power-One, Inc.
2. TECHNICAL REVISIONS - The appearance of products, including safety agency certifications pictured on labels, may change depending on the date manufactured. Specifications are subject to change without notice.