

PROTECTION PRODUCTS - MicroClamp[®]
Description

μ Clamp[®] TVS diodes are designed to protect sensitive electronics from damage or latch-up due to EOS, lightning, CDE, and ESD. They feature large cross-sectional area junctions for conducting high transient currents. These devices offer desirable characteristics for board level protection including fast response time, low operating and clamping voltage, and no device degradation. The μ Clamp[®]xx71P series are in 2-pin SGP1610N2 package measuring 1.6 x 1.0 mm with a nominal height of 0.57mm. The leads are finished with lead-free NiPdAu. They may be used to protect 5V, 8V, 10V, 12V, 15V, 18V, 22V, 26V, and 36V systems. They feature high surge current capability and low clamping voltage making them ideal for use in harsh transient environments.

Features

- ◆ Transient protection for high-speed data lines to **IEC 61000-4-2 (ESD) 30kV (air), 30kV (contact)**
IEC 61000-4-4 (EFT) 40A (5/50ns)
IEC 61000-4-5 (Lightning) 20 - 80A (8/20 μ s)
- ◆ Protects one data or power line
- ◆ Low leakage current
- ◆ High peak pulse current capability
- ◆ Operating voltage options: **5V, 8V, 10V, 12V, 15V, 18V, 22V, 26V, 36V**
- ◆ Qualified to AEC-Q100
- ◆ Solid-state silicon-avalanche technology

Mechanical Characteristics

- ◆ SGP1610N2 package
- ◆ Pb-Free, Halogen Free, RoHS/WEEE Compliant
- ◆ Nominal Dimensions: 1.6 x 1.0 x 0.57 mm
- ◆ Lead Finish: NiPdAu
- ◆ Marking: Marking code
- ◆ Packaging: Tape and Reel

Applications

- ◆ Cellular Handsets & Accessories
- ◆ USB Voltage Bus
- ◆ Battery Protection
- ◆ Digital Lines
- ◆ Proximity Sensors
- ◆ Automotive Applications

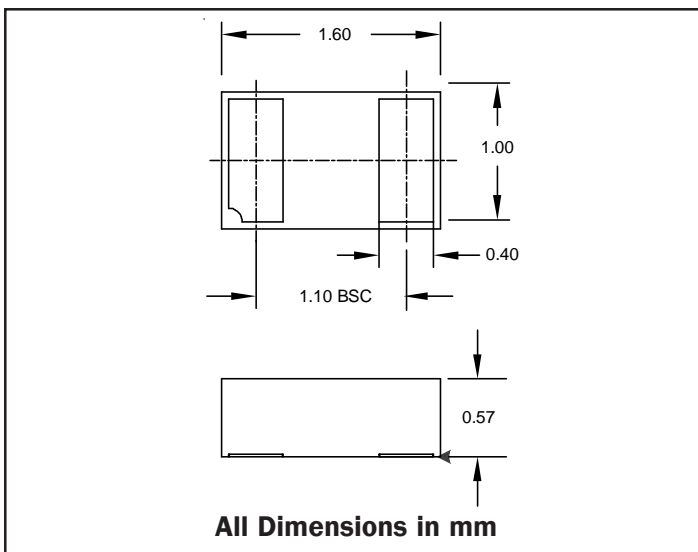
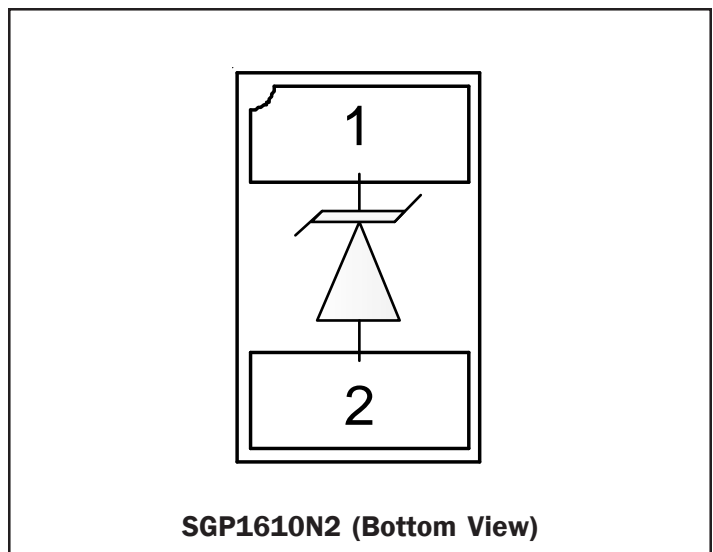
Nominal Dimensions

Schematic

PROTECTION PRODUCTS
Absolute Maximum Rating

Rating	Symbol	Value	Units
Peak Pulse Power ($t_p = 8/20\mu s$) ¹	P_{pk}	1200 - 1500	Watts
ESD per IEC 61000-4-2 (Air) ² ESD per IEC 61000-4-2 (Contact) ²	V_{ESD}	+/- 30 +/- 30	kV
Operating Temperature	T_J	-40 to +125	°C
Storage Temperature	T_{STG}	-55 to +150	°C

Electrical Characteristics (T=25°C unless otherwise specified)

uClamp0571P						
Parameter	Symbol	Conditions	Minimum	Typical	Maximum	Units
Reverse Stand-Off Voltage	V_{RWM}	Pin 1 to 2			5	V
Reverse Breakdown Voltage	V_{BR}	$I_t = 1mA$ Pin 1 to 2	6	7	9	V
Reverse Leakage Current	I_R	$V_{RWM} = 5V, T=25^\circ C$ Pin 1 to 2		<10	100	nA
Peak Pulse Current	I_{PP}	$t_p = 8/20\mu s$ Pin 1 to 2			80	A
Clamping Voltage	V_C	$I_{PP} = 40A, t_p = 8/20\mu s$ Pin 1 to 2			10	V
Clamping Voltage	V_C	$I_{PP} = 80A, t_p = 8/20\mu s$ Pin 1 to 2			15	V
Dynamic Resistance ^{3, 4}	R_{DYN}	$t_{lp} = 0.2 / 100ns$		0.05		Ohms
Junction Capacitance	C_j	$V_R = 0V, f = 1MHz$			675	pF

PROTECTION PRODUCTS

uClamp0871P						
Parameter	Symbol	Conditions	Minimum	Typical	Maximum	Units
Reverse Stand-Off Voltage	V_{RWM}	Pin 1 to 2			8	V
Reverse Breakdown Voltage	V_{BR}	$I_t = 1mA$ Pin 1 to 2	9.5	11	13	V
Reverse Leakage Current	I_R	$V_{RWM} = 8V, T=25^\circ C$ Pin 1 to 2		<10	100	nA
Peak Pulse Current	I_{PP}	$t_p = 8/20\mu s$ Pin 1 to 2			65	A
Clamping Voltage	V_C	$I_{PP} = 10A, t_p = 8/20\mu s$ Pin 1 to 2			15	V
Clamping Voltage	V_C	$I_{PP} = 65A, t_p = 8/20\mu s$ Pin 1 to 2			23	V
Dynamic Resistance ^{3, 4}	R_{DYN}	$t_{lp} = 0.2 / 100ns$		0.05		Ohms
Junction Capacitance	C_j	$V_R = 0V, f = 1MHz$			475	pF

uClamp1071P						
Parameter	Symbol	Conditions	Minimum	Typical	Maximum	Units
Reverse Stand-Off Voltage	V_{RWM}	Pin 1 to 2			10	V
Reverse Breakdown Voltage	V_{BR}	$I_t = 1mA$ Pin 1 to 2	12	13.5	15.5	V
Reverse Leakage Current	I_R	$V_{RWM} = 10V, T=25^\circ C$ Pin 1 to 2		<10	100	nA
Peak Pulse Current	I_{PP}	$t_p = 8/20\mu s$ Pin 1 to 2			60	A
Clamping Voltage	V_C	$I_{PP} = 10A, t_p = 8/20\mu s$ Pin 1 to 2			17	V
Clamping Voltage	V_C	$I_{PP} = 60A, t_p = 8/20\mu s$ Pin 1 to 2			25	V
Dynamic Resistance ^{3, 4}	R_{DYN}	$t_{lp} = 0.2 / 100ns$		0.05		Ohms
Junction Capacitance	C_j	$V_R = 0V, f = 1MHz$			350	pF

PROTECTION PRODUCTS

Electrical Characteristics (T=25°C unless otherwise specified)

uClamp1271P						
Parameter	Symbol	Conditions	Minimum	Typical	Maximum	Units
Reverse Stand-Off Voltage	V_{RWM}	Pin 1 to 2			12	V
Reverse Breakdown Voltage	V_{BR}	$I_t = 1mA$ Pin 1 to 2	14	16	19	V
Reverse Leakage Current	I_R	$V_{RWM} = 12V, T=25^\circ C$ Pin 1 to 2		<10	100	nA
Peak Pulse Current	I_{PP}	$t_p = 8/20\mu s$ Pin 1 to 2			45	A
Clamping Voltage	V_C	$I_{PP} = 10A, t_p = 8/20\mu s$ Pin 1 to 2			22	V
Clamping Voltage	V_C	$I_{PP} = 45A, t_p = 8/20\mu s$ Pin 1 to 2			30	V
Dynamic Resistance ^{3, 4}	R_{DYN}	$t_{lp} = 0.2 / 100ns$		0.05		Ohms
Junction Capacitance	C_j	$V_R = 0V, f = 1MHz$			275	pF

uClamp1571P						
Parameter	Symbol	Conditions	Minimum	Typical	Maximum	Units
Reverse Stand-Off Voltage	V_{RWM}	Pin 1 to 2			15	V
Reverse Breakdown Voltage	V_{BR}	$I_t = 1mA$ Pin 1 to 2	17.5	20	23	V
Reverse Leakage Current	I_R	$V_{RWM} = 15V, T=25^\circ C$ Pin 1 to 2		<10	100	nA
Peak Pulse Current	I_{PP}	$t_p = 8/20\mu s$ Pin 1 to 2			40	A
Clamping Voltage	V_C	$I_{PP} = 10A, t_p = 8/20\mu s$ Pin 1 to 2			25	V
Clamping Voltage	V_C	$I_{PP} = 40A, t_p = 8/20\mu s$ Pin 1 to 2			40	V
Dynamic Resistance ^{3, 4}	R_{DYN}	$t_{lp} = 0.2 / 100ns$		0.05		Ohms
Junction Capacitance	C_j	$V_R = 0V, f = 1MHz$			220	pF

PROTECTION PRODUCTS
uClamp1871P

Parameter	Symbol	Conditions	Minimum	Typical	Maximum	Units
Reverse Stand-Off Voltage	V_{RWM}	Pin 1 to 2			18	V
Reverse Breakdown Voltage	V_{BR}	$I_t = 1mA$ Pin 1 to 2	20	22	25	V
Reverse Leakage Current	I_R	$V_{RWM} = 18V, T=25^{\circ}C$ Pin 1 to 2		<10	100	nA
Peak Pulse Current	I_{PP}	$t_p = 8/20\mu s$ Pin 1 to 2			35	A
Clamping Voltage	V_C	$I_{PP} = 10A, t_p = 8/20\mu s$ Pin 1 to 2			28	V
Clamping Voltage	V_C	$I_{PP} = 35A, t_p = 8/20\mu s$ Pin 1 to 2			45	V
Dynamic Resistance ^{3, 4}	R_{DYN}	$t_{lp} = 0.2 / 100ns$		0.10		Ohms
Junction Capacitance	C_J	$V_R = 0V, f = 1MHz$			225	pF

uClamp2271P

Parameter	Symbol	Conditions	Minimum	Typical	Maximum	Units
Reverse Stand-Off Voltage	V_{RWM}	Pin 1 to 2			22	V
Reverse Breakdown Voltage	V_{BR}	$I_t = 1mA$ Pin 1 to 2	25.5	29	33.5	V
Reverse Leakage Current	I_R	$V_{RWM} = 22V, T=25^{\circ}C$ Pin 1 to 2		<10	100	nA
Peak Pulse Current	I_{PP}	$t_p = 8/20\mu s$ Pin 1 to 2			25	A
Clamping Voltage	V_C	$I_{PP} = 10A, t_p = 8/20\mu s$ Pin 1 to 2			40	V
Clamping Voltage	V_C	$I_{PP} = 25A, t_p = 8/20\mu s$ Pin 1 to 2			55	V
Dynamic Resistance ^{3, 4}	R_{DYN}	$t_{lp} = 0.2 / 100ns$		0.10		Ohms
Junction Capacitance	C_J	$V_R = 0V, f = 1MHz$			165	pF

PROTECTION PRODUCTS

Electrical Characteristics (T=25°C unless otherwise specified)

uClamp2671P						
Parameter	Symbol	Conditions	Minimum	Typical	Maximum	Units
Reverse Stand-Off Voltage	V_{RWM}	Pin 1 to 2			26	V
Reverse Breakdown Voltage	V_{BR}	$I_t = 1mA$ Pin 1 to 2	29	32	35	V
Reverse Leakage Current	I_R	$V_{RWM} = 26V, T=25^\circ C$ Pin 1 to 2		<10	100	nA
Peak Pulse Current	I_{PP}	$t_p = 8/20\mu s$ Pin 1 to 2			23	A
Clamping Voltage	V_C	$I_{PP} = 10A, t_p = 8/20\mu s$ Pin 1 to 2			50	V
Clamping Voltage	V_C	$I_{PP} = 23A, t_p = 8/20\mu s$ Pin 1 to 2			65	V
Dynamic Resistance ^{3, 4}	R_{DYN}	$t_{lp} = 0.2 / 100ns$		0.15		Ohms
Junction Capacitance	C_J	$V_R = 0V, f = 1MHz$			155	pF

uClamp3671P						
Parameter	Symbol	Conditions	Minimum	Typical	Maximum	Units
Reverse Stand-Off Voltage	V_{RWM}	Pin 1 to 2			36	V
Reverse Breakdown Voltage	V_{BR}	$I_t = 1mA$ Pin 1 to 2	37		44	V
Reverse Leakage Current	I_R	$V_{RWM} = 36V, T=25^\circ C$ Pin 1 to 2		<10	100	nA
Peak Pulse Current	I_{PP}	$t_p = 8/20\mu s$ Pin 1 to 2			18	A
Clamping Voltage	V_C	$I_{PP} = 2A, t_p = 1.2/50\mu s$ Pin 1 to 2			48	V
Clamping Voltage	V_C	$I_{PP} = 18A, t_p = 8/20\mu s$ Pin 1 to 2			80	V
Dynamic Resistance ^{3, 4}	R_{DYN}	$t_{lp} = 0.2 / 100ns$		0.29		Ohms
Junction Capacitance	C_J	$V_R = 0V, f = 1MHz$			150	pF

Notes

- 1) Peak Pulse Power = $V_{C(max)} \times I_{PP(Max)}$ ($t_p = 8/20\mu s$)
- 2) ESD gun return path connected to ESD ground reference plane.
- 3) Transmission Line Pulse Test (TLP) Settings: $t_p = 100ns, t_r = 0.2ns, I_{TLP}$ and V_{TLP} averaging window: $t_1 = 70ns$ to $t_2 = 90ns$.
- 4) Dynamic resistance calculated from $I_{TLP} = 4A$ to $I_{TLP} = 16A$

PROTECTION PRODUCTS

Typical Characteristics

Non-Repetitive Peak Pulse Power vs. Pulse Time

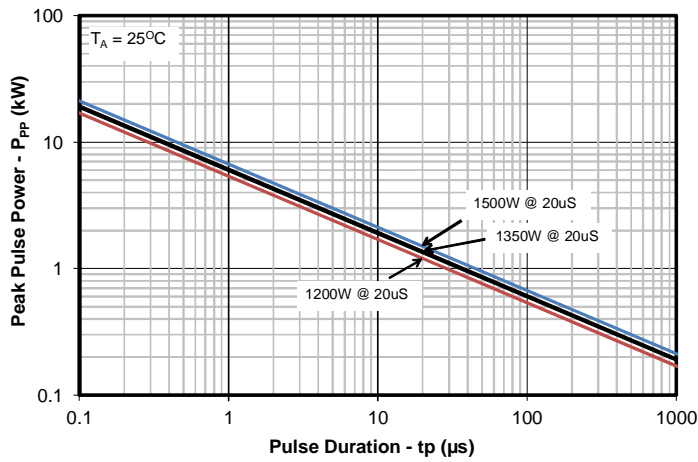

Clamping Voltage vs. Peak Pulse Current ($t_p=8/20\mu$ s)

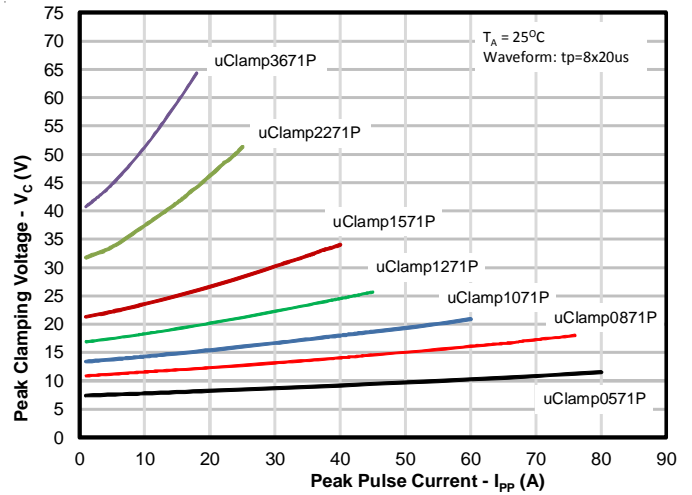

Forward Voltage vs. Peak Pulse Current ($t_p=8/20\mu$ s)

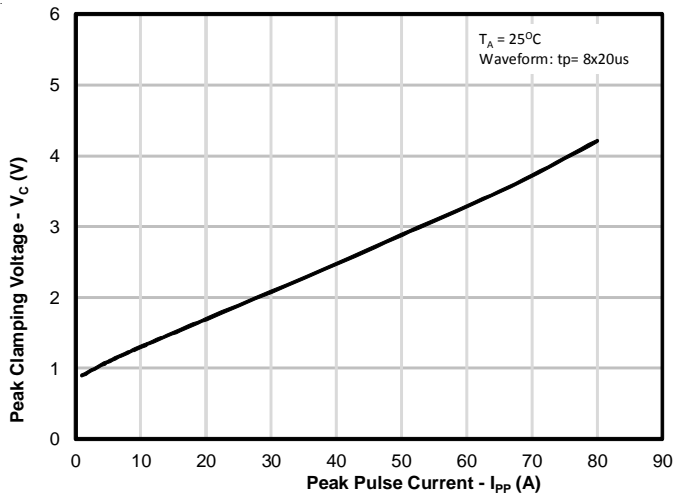

TLP Characteristic

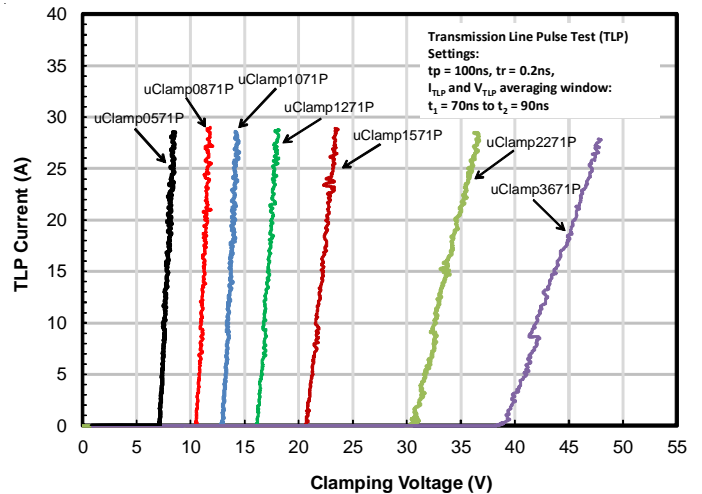

ESD Clamping - uClamp0571P (+8kV Contact per IEC 61000-4-2)

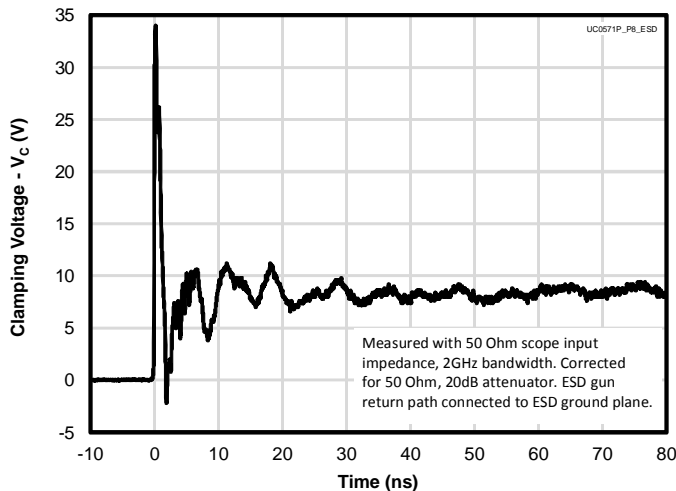

ESD Clamping - uClamp0571P (-8kV Contact per IEC 61000-4-2)

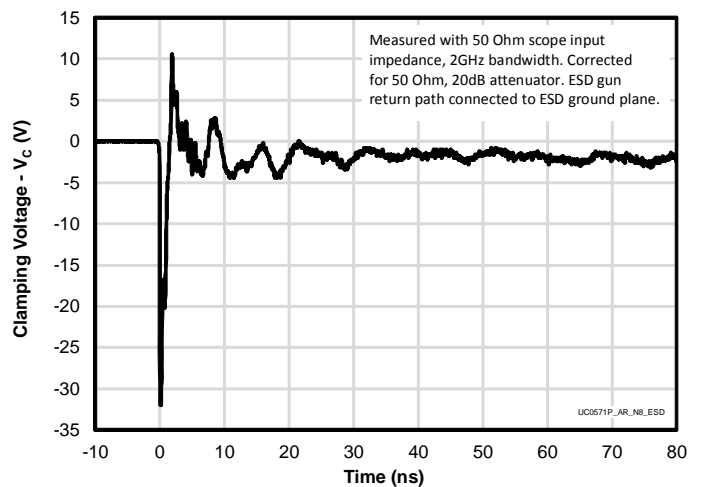

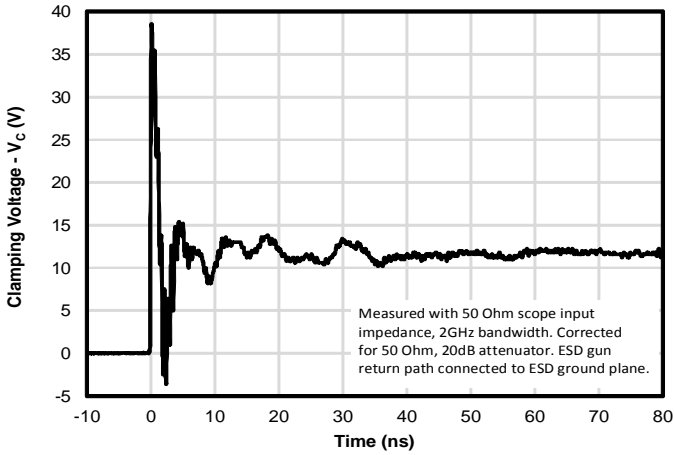
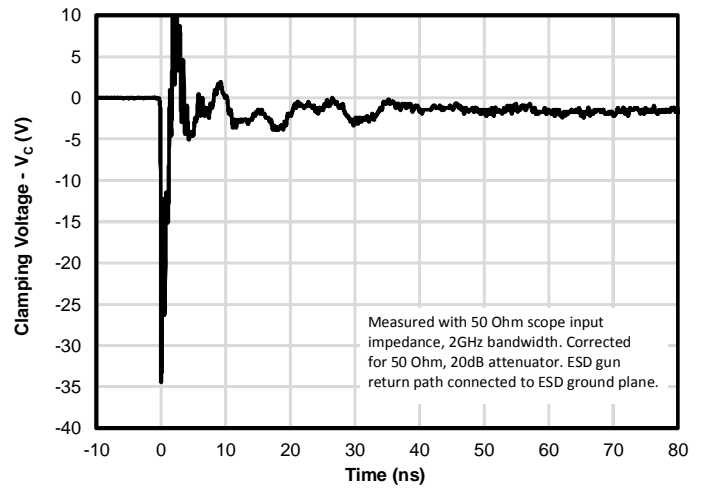
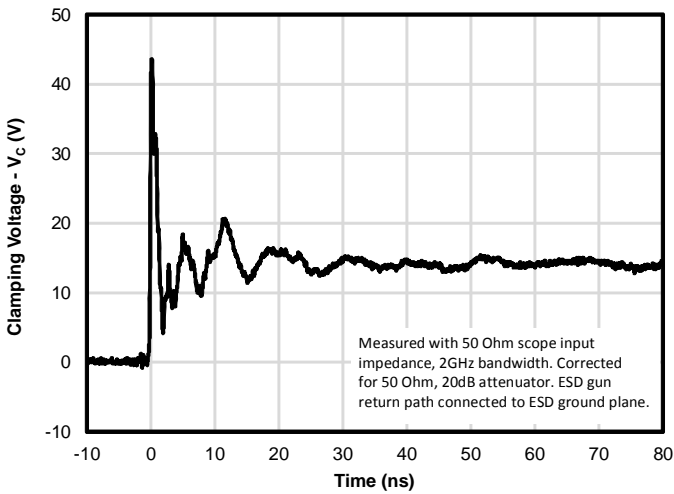
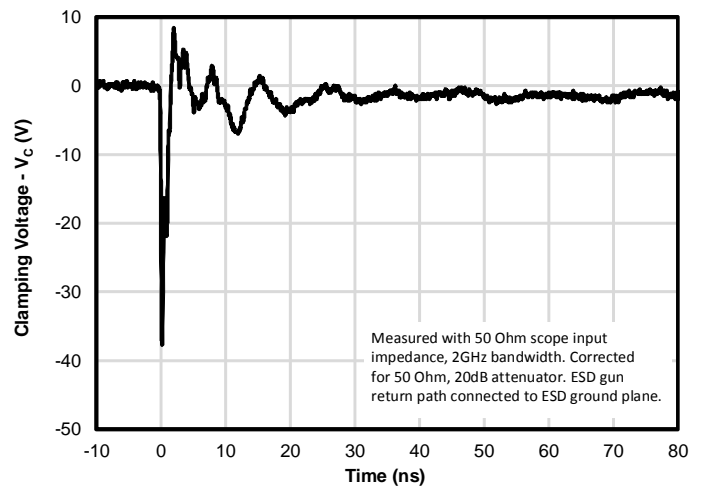
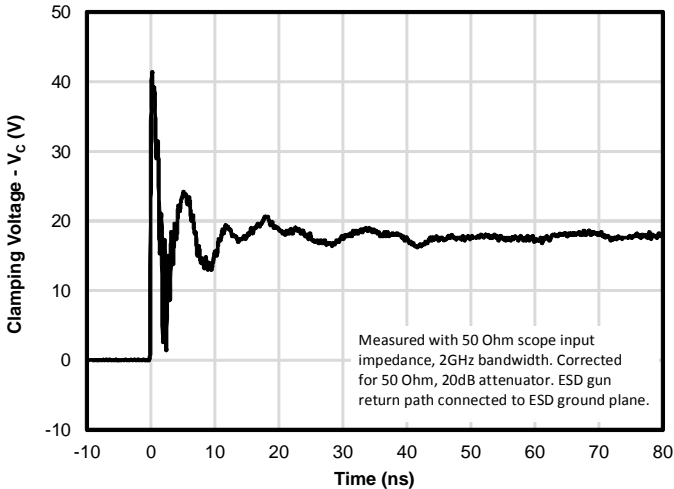
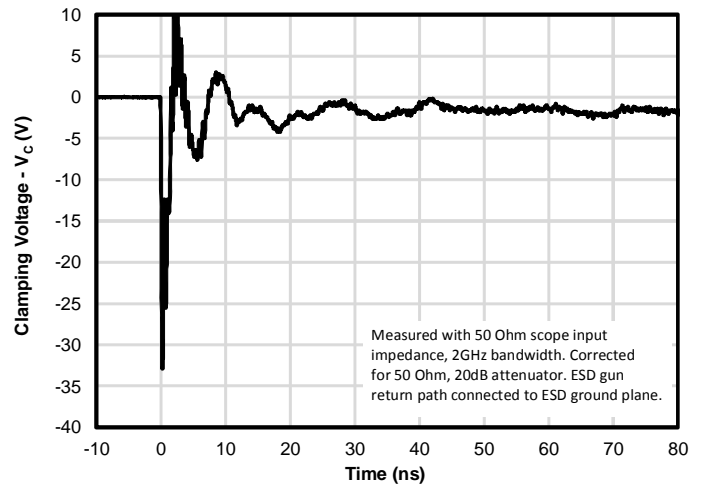
PROTECTION PRODUCTS
Typical Characteristics
**ESD Clamping - uClamp0871P
(+8kV Contact per IEC 61000-4-2)**

**ESD Clamping - uClamp0871P
(-8kV Contact per IEC 61000-4-2)**

**ESD Clamping - uClamp1071P
(+8kV Contact per IEC 61000-4-2)**

**ESD Clamping - uClamp1071P
(-8kV Contact per IEC 61000-4-2)**

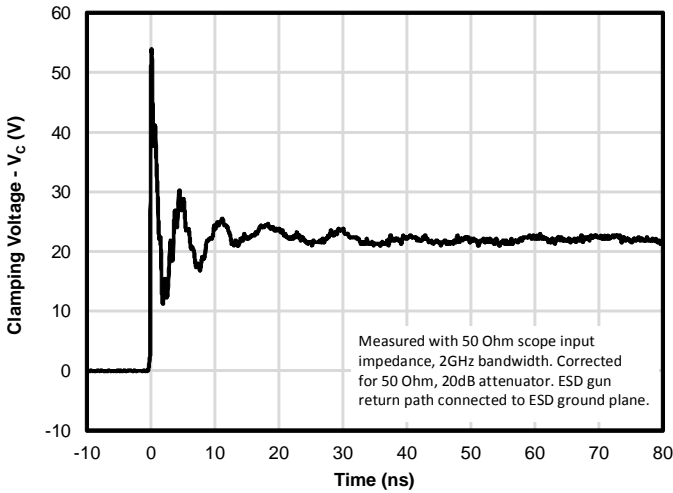
**ESD Clamping - uClamp1271P
(+8kV Contact per IEC 61000-4-2)**

**ESD Clamping - uClamp1271P
(-8kV Contact per IEC 61000-4-2)**

PROTECTION PRODUCTS

Typical Characteristics

ESD Clamping - uClamp1571P
 (+8kV Contact per IEC 61000-4-2)



ESD Clamping - uClamp1571P
 (-8kV Contact per IEC 61000-4-2)

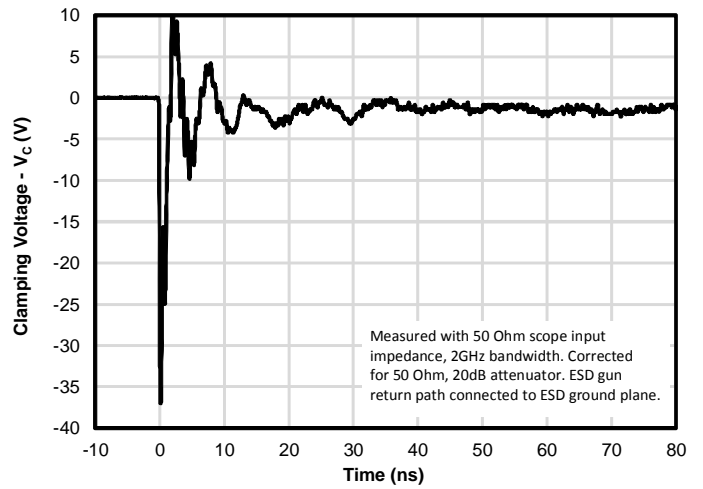

ESD Clamping - uClamp1871P
 (+8kV Contact per IEC 61000-4-2)

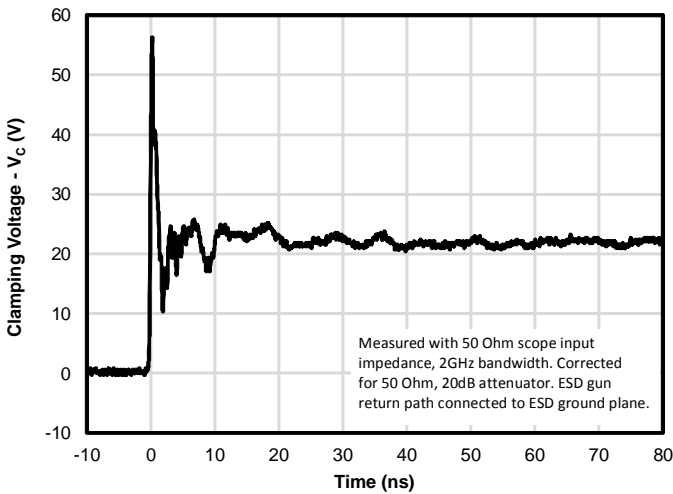

ESD Clamping - uClamp1871P
 (-8kV Contact per IEC 61000-4-2)

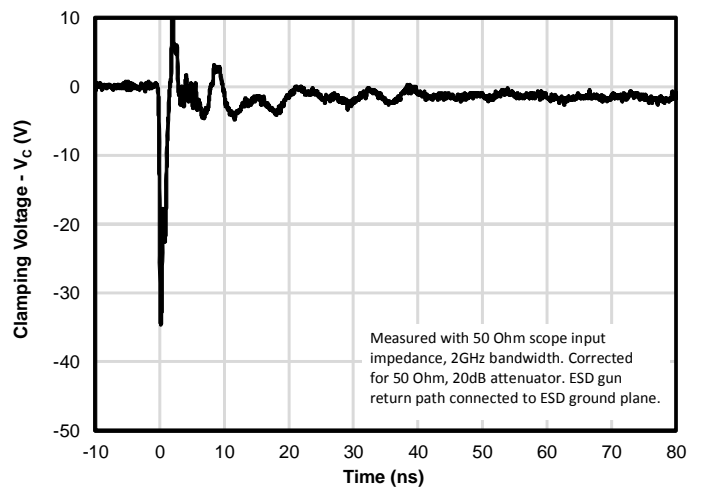

ESD Clamping - uClamp2271P
 (+8kV Contact per IEC 61000-4-2)

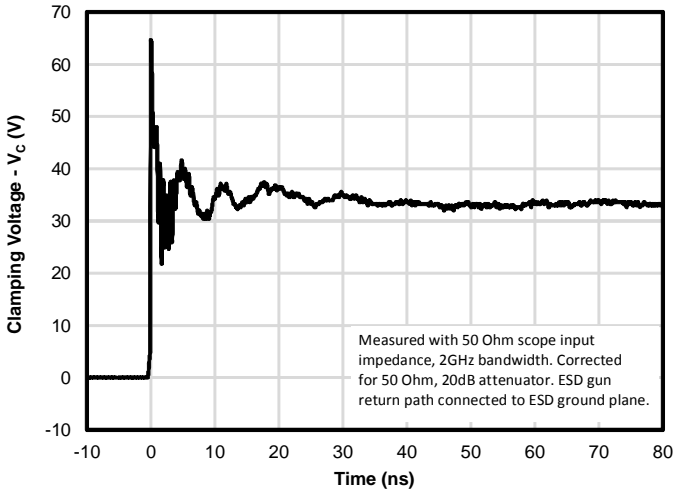

ESD Clamping - uClamp2271P
 (-8kV Contact per IEC 61000-4-2)

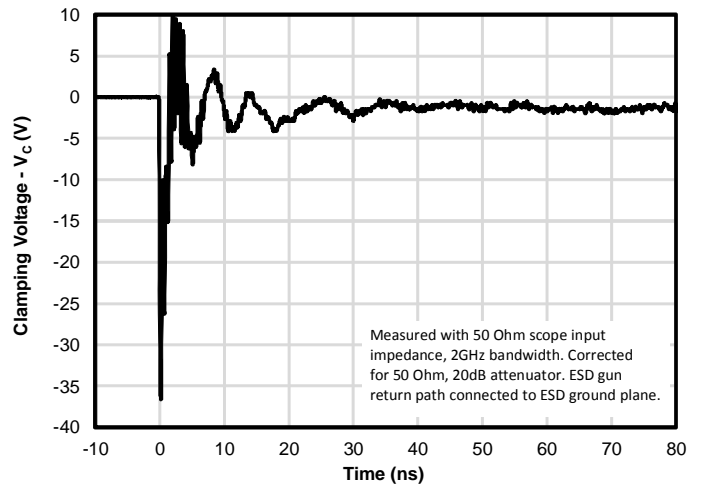

PROTECTION PRODUCTS

Typical Characteristics

**ESD Clamping - uClamp2671P
(+8kV Contact per IEC 61000-4-2)**

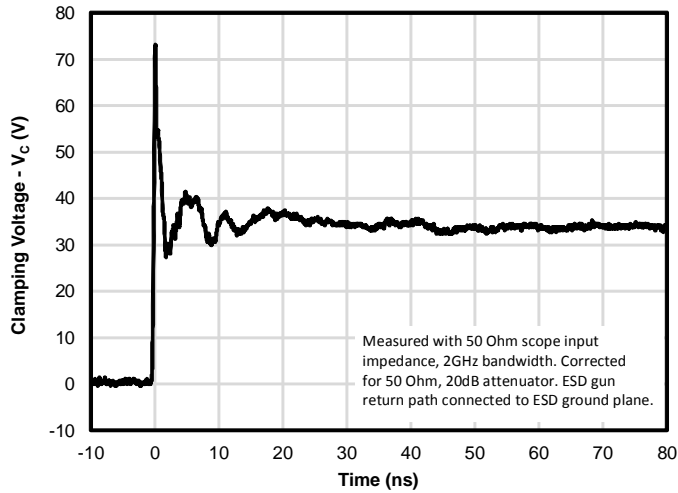

**ESD Clamping - uClamp2671P
(-8kV Contact per IEC 61000-4-2)**

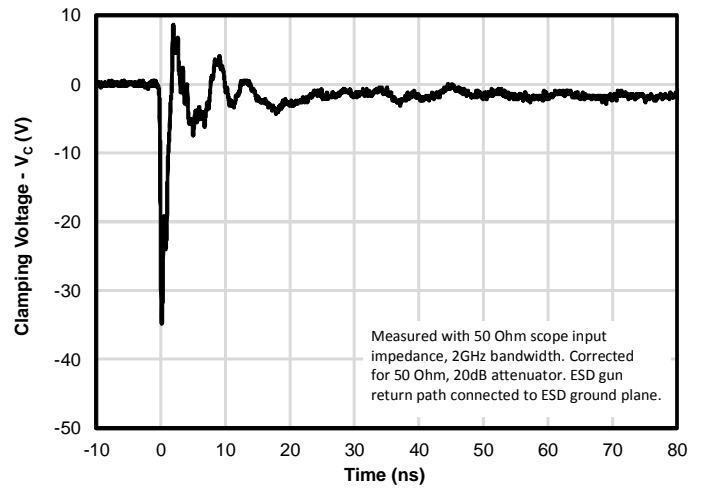

**ESD Clamping - uClamp3671P
(+8kV Contact per IEC 61000-4-2)**

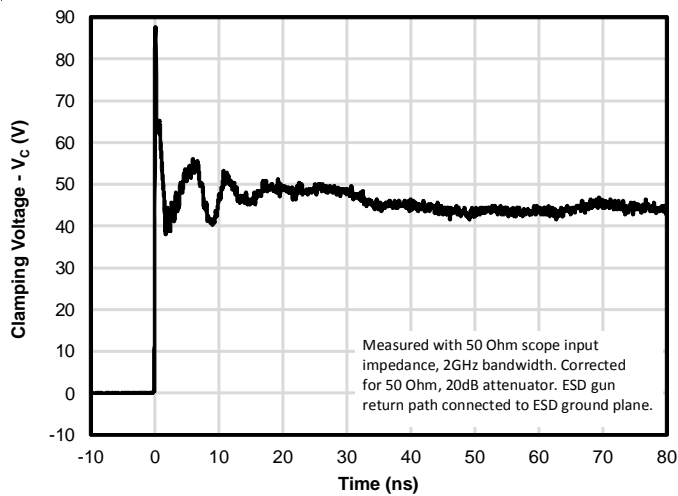

**ESD Clamping - uClamp3671P
(-8kV Contact per IEC 61000-4-2)**

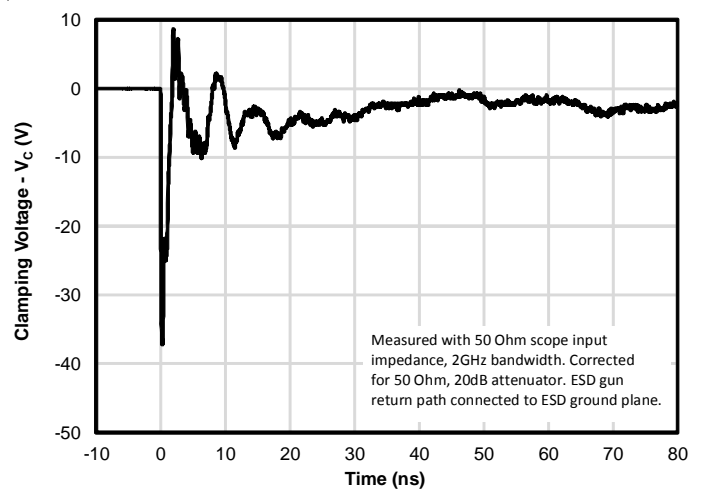

PROTECTION PRODUCTS

Applications Information

Assembly Guidelines

The table below provides Semtech's recommended assembly guidelines for mounting this device. The figure at the right details Semtech's recommended aperture based on the below recommendations. Note that these are only recommendations and should serve only as a starting point for design since there are many factors that affect the assembly process. The exact manufacturing parameters will require some experimentation to get the desired solder application.

Assembly Parameter	Recommendation
Solder Stencil Design	Laser cut, Electro-polished
Aperture shape	Rectangular with rounded corners
Solder Stencil Thickness	0.125 mm (0.005")
Solder Paste Type	Type 3 size sphere or smaller
Solder Reflow Profile	Per JEDEC J-STD-020
PCB Solder Pad Design	Non-Solder mask defined
PCB Pad Finish	OSP OR NiAu

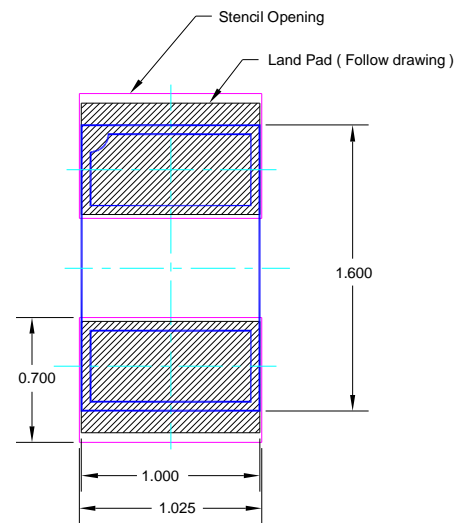

All Dimensions are in mm.

 Land Pad.
  Stencil opening
  Component

Recommended Mounting Pattern

PROTECTION PRODUCTS

Outline Drawing - SGP1610N2

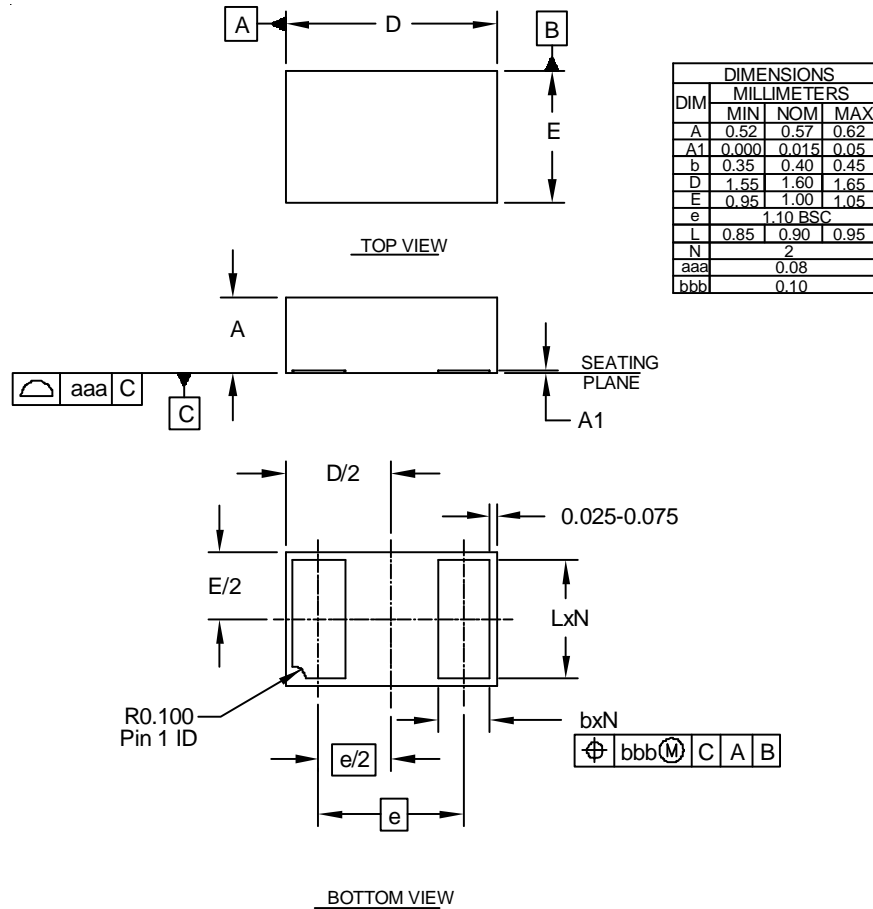

NOTES:
1. CONTROLLING DIMENSIONS ARE IN MILLIMETERS (ANGLES IN DEGREES).

Land Pattern - SGP1610N2

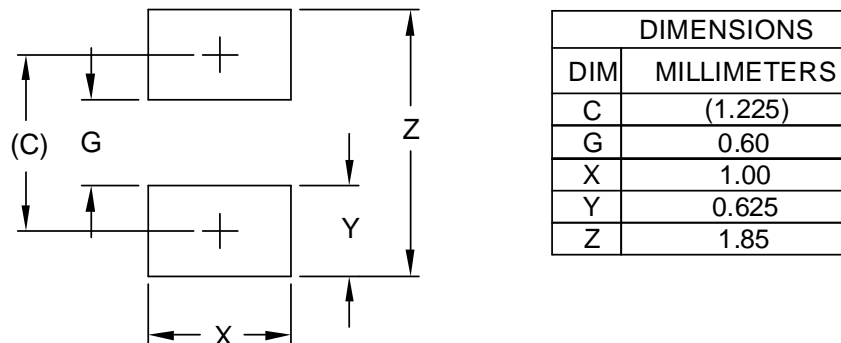

NOTES:
1. CONTROLLING DIMENSIONS ARE IN MILLIMETERS (ANGLES IN DEGREES).
2. THIS LAND PATTERN IS FOR REFERENCE PURPOSES ONLY.
CONSULT YOUR MANUFACTURING GROUP TO ENSURE YOUR COMPANY'S MANUFACTURING GUIDELINES ARE MET.

PROTECTION PRODUCTS

Example Device Marking

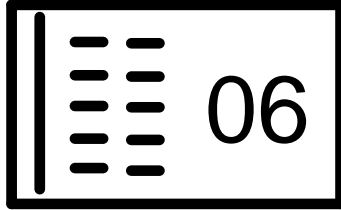

Notes:

1) Marking includes marking code, pin 1 bar, and 2x5 matrix date code

Ordering Information

Part Number	Marking Code	Working Voltage	Qty per Reel
uClamp0571P.TNT	06	5V	10,000
uClamp0871P.TNT	11	8V	10,000
uClamp1071P.TNT	12	10V	10,000
uClamp1271P.TNT	16	12V	10,000
uClamp1571P.TNT	18	15V	10,000
uClamp1871P.TNT	24	18V	10,000
uClamp2271P.TNT	26	22V	10,000
uClamp2671P.TNT	30	26V	10,000
uClamp3671P.TNT	37	36V	10,000

Notes:

MicroClamp, uClamp and μ Clamp are trademarks of Semtech Corporation

PROTECTION PRODUCTS

Carrier Tape Specification

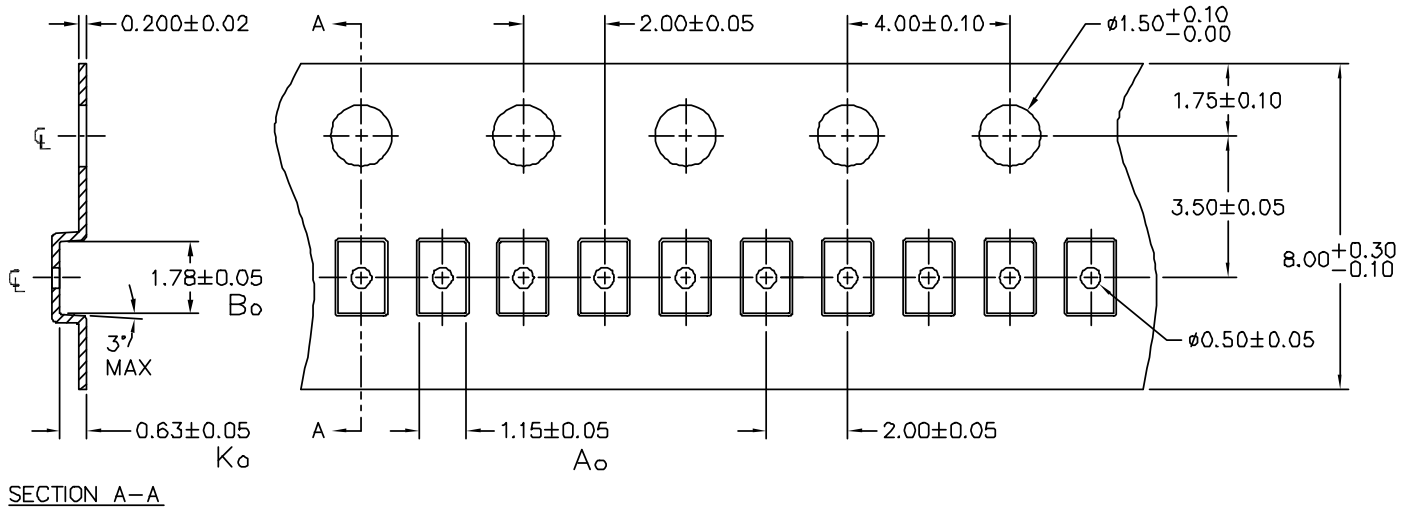

NOTES: 1.) ALL DIMENSIONS IN MILLIMETERS UNLESS OTHERWISE SPECIFIED.

Note: All dimensions in mm unless otherwise specified

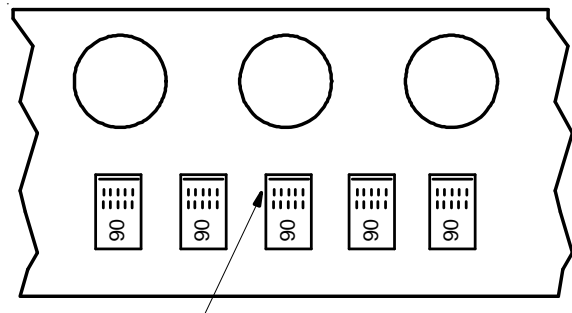

PIN 1 Location
(Towards Sprocket Holes)

Device Orientation in Tape

Contact Information

Semtech Corporation
 Protection Products Division
 200 Flynn Rd., Camarillo, CA 93012
 Phone: (805)498-2111 FAX (805)498-3804