

SAW FILTER TEST & BURN IN SOCKET

AXS-3838-08-01

Precision test socket for 3.8x3.8mm, 8 pad SAW filter packages.



RoHS
Compliant



FEATURES:

- Accurate and reliable testing of frequency control devices
- Contact force ideal for avoiding measurement error
- Highest quality socket available
- Clam shell design for easy open and close
- Reliable gold plated POGO pins
- Suitable for high temperature burn-in test
- Operating Temperature: -30 ~ +150°C

APPLICATIONS:

- Design stage component engineering evaluation
- Supplier comparison tests
- High temperature burn-in board testing
- Prototyping

SIDE VIEW (OPEN):

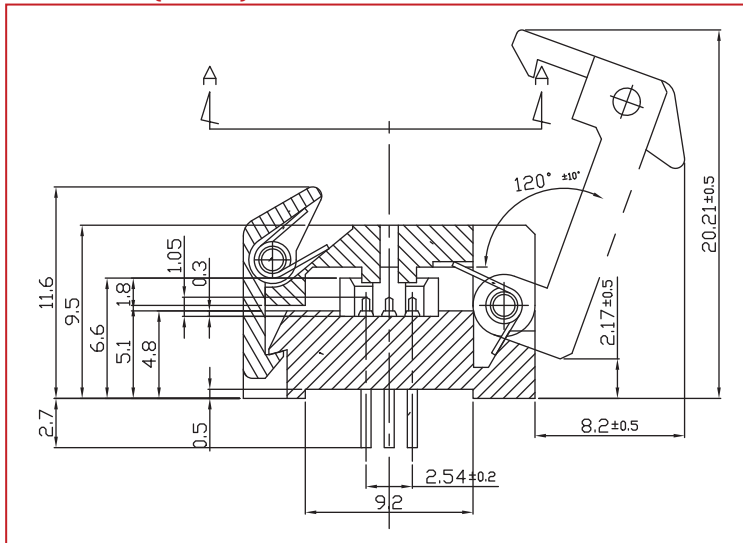

POCKET TOP VIEW:

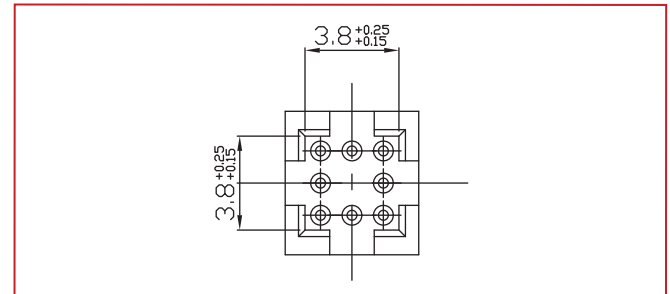

END VIEW:

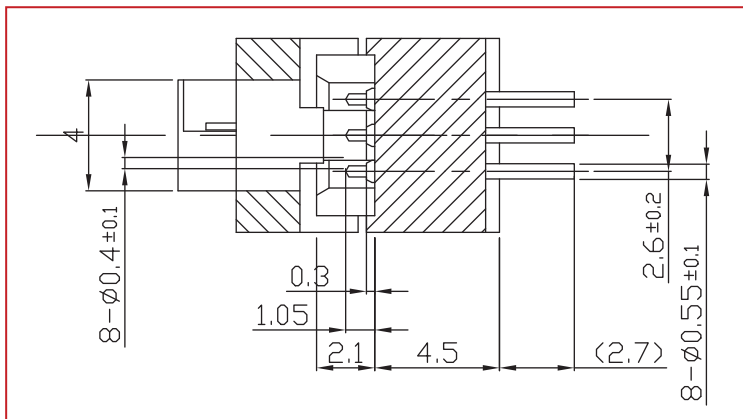

PIN DIMENSIONS:

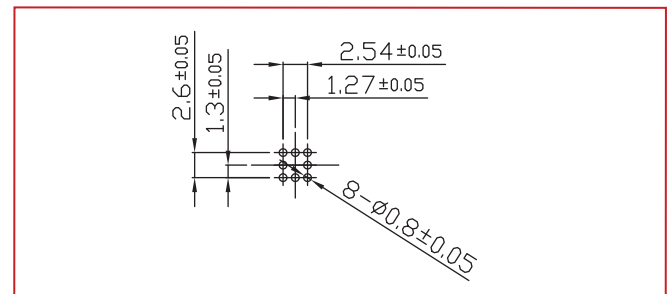

SUITABLE SAW FILTER PACKAGE DIMENSIONS:

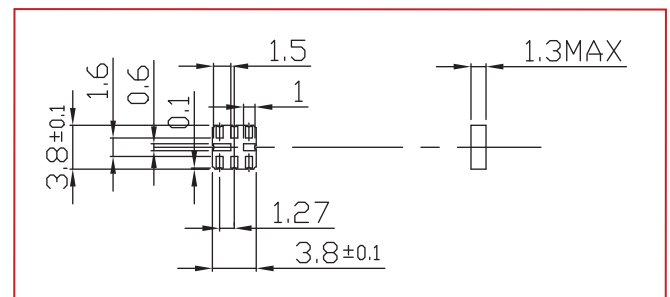

Dimensions: mm

ORDERING INFORMATION:

When ordering, please refer to part number

AXS-3838-08-01

RECOMMENDED FOR USE WITH DEVICE PACKAGE DIMENSIONS:

3.8 x 3.8 x 1.2mm

COMPATIBLE ABRACON SURFACE MOUNT SAW FILTER:

3.8 x 3.8 x 1.2mm 8 pad SAW filter

(for a pdf download go to www.abracon.com/sawfilters.htm)

* ABRACON test and burn in sockets are compatible with all industry standard frequency control packages.

ABRACON IS
ISO 9001 / QS 9000
CERTIFIED



ABRACON
CORPORATION

Visit www.abracon.com for Terms & Conditions of Sale **Revised: 07.10.09**
30332 Esperanza, Rancho Santa Margarita, California 92688
tel 949-546-8000 | fax 949-546-8001 | www.abracon.com