

■ Features :

- Protections: Short circuit / Overload / Over voltage
- Cooling by free air convection
- LED indicator for power on
- 100% full load burn-in test
- 2 years warranty



SPECIFICATION

MODEL	NES-100-5	NES-100-7.5	NES-100-9	NES-100-12	NES-100-15	NES-100-24	NES-100-48	
OUTPUT	DC VOLTAGE	5V	7.5V	9V	12V	15V	24V	48V
	RATED CURRENT	20A	13.6A	11.2A	8.5A	7A	4.5A	2.3A
	CURRENT RANGE	0 ~ 20A	0 ~ 13.6A	0 ~ 11.2A	0 ~ 8.5A	0 ~ 7A	0 ~ 4.5A	0 ~ 2.3A
	RATED POWER	100W	102W	100.8W	102W	105W	108W	110.4W
	RIPPLE & NOISE (max.) Note.2	80mVp-p	120mVp-p	120mVp-p	120mVp-p	120mVp-p	120mVp-p	150mVp-p
	VOLTAGE ADJ. RANGE	4.75 ~ 5.5V	7.13 ~ 8.3V	8.55 ~ 9.9V	11.4 ~ 13.2V	14.25 ~ 16.5V	22.8 ~ 26.4V	45.6 ~ 52.8V
	VOLTAGE TOLERANCE Note.3	±2.0%	±1.0%	±1.0%	±1.0%	±1.0%	±1.0%	±1.0%
	LINE REGULATION Note.4	±0.5%	±0.5%	±0.5%	±0.5%	±0.5%	±0.5%	±0.5%
	LOAD REGULATION Note.5	±0.5%	±0.5%	±0.5%	±0.5%	±0.5%	±0.5%	±0.5%
	SETUP, RISE TIME	1000ms, 20ms/230VAC 1000ms, 20ms/115VAC at full load						
HOLD UP TIME (Typ.)	30ms/230VAC 25ms/115VAC at full load							
INPUT	VOLTAGE RANGE	85 ~ 132VAC / 176 ~ 264VAC selected by switch			248 ~ 373VDC			
	FREQUENCY RANGE	47 ~ 63Hz						
	EFFICIENCY (Typ.)	80%	81%	81%	83%	84%	86%	86%
	AC CURRENT (Typ.)	2A/115VAC		1.2A/230VAC				
	INRUSH CURRENT (Typ.)	COLD START 45A						
	LEAKAGE CURRENT	<2mA / 240VAC						
PROTECTION	OVERLOAD	110 ~ 150% rated output power Protection type : Hiccup mode, recovers automatically after fault condition is removed						
	OVER VOLTAGE	5.75 ~ 6.75V	8.6 ~ 10.1V	10.4 ~ 12.2V	13.8 ~ 16.2V	17.25 ~ 20.25V	27.6 ~ 32.4V	55.2 ~ 64.8V
ENVIRONMENT	WORKING TEMP.	-20 ~ +60°C (Refer to "Derating Curve")						
	WORKING HUMIDITY	20 ~ 90% RH non-condensing						
	STORAGE TEMP., HUMIDITY	-40 ~ +85°C, 10 ~ 95% RH						
	TEMP. COEFFICIENT	±0.03%/°C (0 ~ 50°C)						
	VIBRATION	10 ~ 500Hz, 2G 10min./1cycle, period for 60min. each along X, Y, Z axes						
SAFETY & EMC (Note 7)	SAFETY STANDARDS Note.6	UL60950-1, CB(IEC60950-1),BSMI (CNS14336-1),CCC GB4943.1:2011 approved						
	WITHSTAND VOLTAGE	I/P-O/P:3KVAC		I/P-FG:2KVAC		O/P-FG:0.5KVAC		
	ISOLATION RESISTANCE	I/P-O/P, I/P-FG, O/P-FG:100M Ohms / 500VDC / 25°C/ 70% RH						
	EMC EMISSION	Compliance to EN55032 (CISPR32) Class B, EN61000-3-2,-3						
	EMC IMMUNITY	Compliance to EN61000-4-2,3,4,5,6,8,11, EN55024, EN61000-6-1, light industry level, criteria A						
OTHERS	MTBF	320.7Khrs min. MIL-HDBK-217F (25°C)						
	DIMENSION	159*97*38mm (L*W*H)						
	PACKING	0.55Kg; 30pcs/17.5Kg/0.97CUFT						
NOTE	<ol style="list-style-type: none"> 1. All parameters not specially mentioned are measured at 230VAC input, rated load and 25°C of ambient temperature. 2. Ripple & noise are measured at 20MHz of bandwidth by using a 12" twisted pair-wire terminated with a 0.1uf & 47uf parallel capacitor. 3. Tolerance : includes set up tolerance, line regulation and load regulation. 4. Line regulation is measured from low line to high line at rated load. 5. Load regulation is measured from 0% to 100% rated load. 6. For the request of GB4943.1,the power supply is only suitable for use in the altitude 2000m below and the non tropical climate condition. 7. The power supply is considered a component which will be installed into a final equipment. The final equipment must be re-confirmed that it still meets EMC directives. For guidance on how to perform these EMC tests, please refer to "EMI testing of component power supplies." (as available on http://www.meanwell.com) 							

■ Mechanical Specification

Case No. 901 Unit:mm

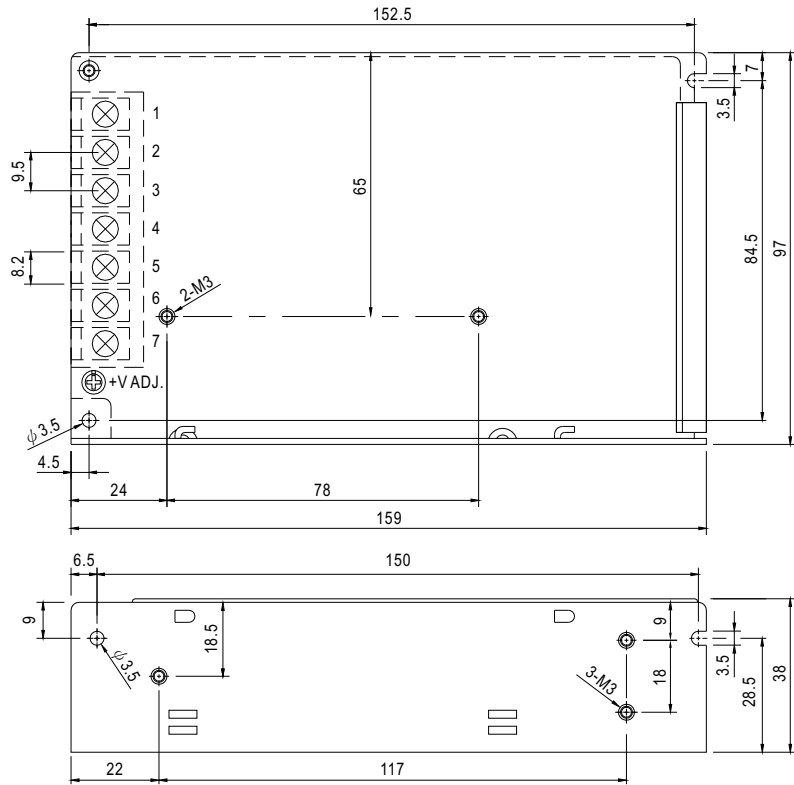

Terminal Pin No. Assignment

Pin No.	Assignment	Pin No.	Assignment
1	AC/L	4,5	DC OUTPUT -V
2	AC/N	6,7	DC OUTPUT +V
3	FG \perp		

■ Block Diagram

fosc : 60KHz

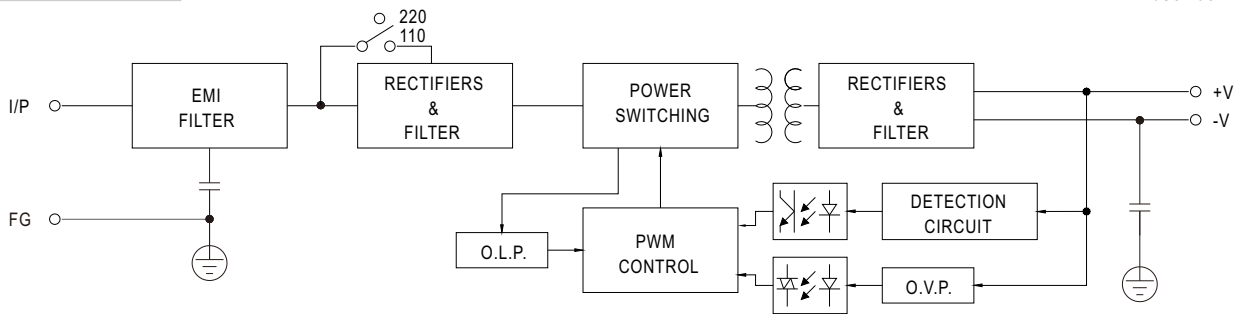

■ Derating Curve

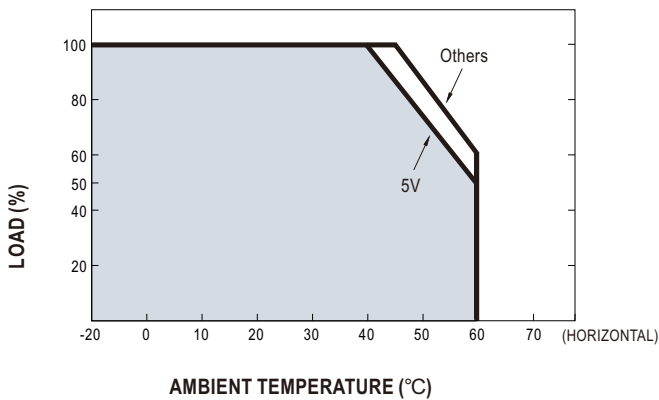

■ Static Characteristics

