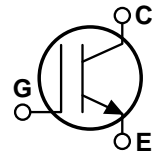
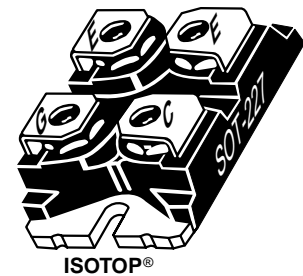

**POWER MOS 7® IGBT**

The POWER MOS 7® IGBT is a new generation of high voltage power IGBTs. Using Punch Through Technology this IGBT is ideal for many high frequency, high voltage switching applications and has been optimized for high frequency switchmode power supplies.

- **Low Conduction Loss**
- **Low Gate Charge**
- **Ultrafast Tail Current shutoff**
- **100 kHz operation @ 400V, 39A**
- **50 kHz operation @ 400V, 59A**
- **SSOA rated**

**MAXIMUM RATINGS**

 All Ratings:  $T_C = 25^\circ\text{C}$  unless otherwise specified.

| Symbol         | Parameter  | APT80GP60J  | UNIT             |
|----------------|--|-------------|------------------|
| $V_{CES}$      | Collector-Emitter Voltage  | 600         | Volts            |
| $V_{GE}$       | Gate-Emitter Voltage   | $\pm 20$    |                  |
| $V_{GEM}$      | Gate-Emitter Voltage Transient                                   | $\pm 30$    |                  |
| $I_{C1}$       | Continuous Collector Current @ $T_C = 25^\circ\text{C}$          | 151         | Amps             |
| $I_{C2}$       | Continuous Collector Current @ $T_C = 110^\circ\text{C}$         | 68          |                  |
| $I_{CM}$       | Pulsed Collector Current <sup>①</sup> @ $T_C = 25^\circ\text{C}$ | 330         |                  |
| SSOA           | Switching Safe Operating Area @ $T_J = 150^\circ\text{C}$        | 330A @ 600V |                  |
| $P_D$          | Total Power Dissipation  | 462         | Watts            |
| $T_J, T_{STG}$ | Operating and Storage Junction Temperature Range                 | -55 to 150  | $^\circ\text{C}$ |
| $T_L$          | Max. Lead Temp. for Soldering: 0.063" from Case for 10 Sec.      | 300         |                  |

**STATIC ELECTRICAL CHARACTERISTICS**

| Symbol       | Characteristic / Test Conditions   | MIN | TYP | MAX       | UNIT  |
|--------------|--|-----|-----|-----------|-------|
| $BV_{CES}$   | Collector-Emitter Breakdown Voltage ( $V_{GE} = 0V, I_C = 1.0mA$ )                               | 600 |     |           | Volts |
| $V_{GE(TH)}$ | Gate Threshold Voltage ( $V_{CE} = V_{GE}, I_C = 2.5mA, T_j = 25^\circ\text{C}$ )                | 3   | 4.5 | 6         |       |
| $V_{CE(ON)}$ | Collector-Emitter On Voltage ( $V_{GE} = 15V, I_C = 80A, T_j = 25^\circ\text{C}$ )               |     | 2.2 | 2.7       |       |
|              | Collector-Emitter On Voltage ( $V_{GE} = 15V, I_C = 80A, T_j = 125^\circ\text{C}$ )              |     | 2.1 |           |       |
| $I_{CES}$    | Collector Cut-off Current ( $V_{CE} = 600V, V_{GE} = 0V, T_j = 25^\circ\text{C}$ ) <sup>②</sup>  |     |     | 1.0       | mA    |
|              | Collector Cut-off Current ( $V_{CE} = 600V, V_{GE} = 0V, T_j = 125^\circ\text{C}$ ) <sup>②</sup> |     |     | 5         |       |
| $I_{GES}$    | Gate-Emitter Leakage Current ( $V_{GE} = \pm 20V$ )  |     |     | $\pm 100$ | nA    |

 **CAUTION:** These Devices are Sensitive to Electrostatic Discharge. Proper Handling Procedures Should Be Followed.

## DYNAMIC CHARACTERISTICS

APT80GP60J

| Symbol       | Characteristic                                | Test Conditions   | MIN   | TYP  | MAX  | UNIT |               |
|--------------|---|---|---|------|------|------|---------------|
| $C_{ies}$    | Input Capacitance                             | <b>Capacitance</b><br>$V_{GE} = 0V, V_{CE} = 25V$<br>$f = 1 \text{ MHz}$  |   | 9840 |      | pF   |               |
| $C_{oes}$    | Output Capacitance                            |   |   | 735  |      |      |               |
| $C_{res}$    | Reverse Transfer Capacitance                  |   |   | 40   |      |      |               |
| $V_{GEP}$    | Gate-to-Emitter Plateau Voltage               | <b>Gate Charge</b><br>$V_{GE} = 15V$<br>$V_{CE} = 300V$<br>$I_C = 80A$  |   | 7.5  |      | V    |               |
| $Q_g$        | Total Gate Charge <sup>③</sup>                |   |   | 280  |      | nC   |               |
| $Q_{ge}$     | Gate-Emitter Charge                           |   |   | 65   |      |      |               |
| $Q_{gc}$     | Gate-Collector ("Miller") Charge              |   |   | 85   |      |      |               |
| SSOA         | Switching SOA                                 | $T_J = 150^\circ\text{C}, R_G = 5\Omega, V_{GE} = 15V, L = 100\mu\text{H}, V_{CE} = 600V$   | 330   |      |      | A    |               |
| $t_{d(on)}$  | Turn-on Delay Time                            | <b>Inductive Switching (25°C)</b><br>$V_{CC} = 400V$<br>$V_{GE} = 15V$<br>$I_C = 80A$<br>$R_G = 5\Omega$<br>$T_J = +25^\circ\text{C}$ |   | 29   |      | ns   |               |
| $t_r$        | Current Rise Time                             |   |   | 40   |      |      |               |
| $t_{d(off)}$ | Turn-off Delay Time                           |   |   | 116  |      |      |               |
| $t_f$        | Current Fall Time                             |   |   | 78   |      |      |               |
| $E_{on1}$    | Turn-on Switching Energy <sup>④</sup>         |   |   |      | 795  |      | $\mu\text{J}$ |
| $E_{on2}$    | Turn-on Switching Energy (Diode) <sup>⑤</sup> |   |   |      | 1536 |      |               |
| $E_{off}$    | Turn-off Switching Energy <sup>⑥</sup>        |   |   |      | 1199 |      |               |
| $t_{d(on)}$  | Turn-on Delay Time                            |   | <b>Inductive Switching (125°C)</b><br>$V_{CC} = 400V$<br>$V_{GE} = 15V$<br>$I_C = 80A$<br>$R_G = 5\Omega$<br>$T_J = +125^\circ\text{C}$ |      | 29   |      | ns            |
| $t_r$        | Current Rise Time                             |   |   | 40   |      |      |               |
| $t_{d(off)}$ | Turn-off Delay Time                           |   |   | 149  |      |      |               |
| $t_f$        | Current Fall Time                             |   |   | 84   |      |      |               |
| $E_{on1}$    | Turn-on Switching Energy <sup>④</sup>         |   |   |      | 795  |      | $\mu\text{J}$ |
| $E_{on2}$    | Turn-on Switching Energy (Diode) <sup>⑤</sup> |   |   |      | 2153 |      |               |
| $E_{off}$    | Turn-off Switching Energy <sup>⑥</sup>        |   |   |      | 1690 |      |               |

## THERMAL AND MECHANICAL CHARACTERISTICS

| Symbol          | Characteristic           | MIN | TYP | MAX  | UNIT               |
|-----------------|--------------------------|-----|-----|------|--------------------|
| $R_{\theta JC}$ | Junction to Case (IGBT)  |     |     | .27  | $^\circ\text{C/W}$ |
| $R_{\theta JC}$ | Junction to Case (DIODE) |     |     | N/A  |                    |
| $W_T$           | Package Weight           |     |     | 29.2 | gm                 |

- ① Repetitive Rating: Pulse width limited by maximum junction temperature.
  - ② For Combi devices,  $I_{ces}$  includes both IGBT and FRED leakages
  - ③ See MIL-STD-750 Method 3471.
  - ④  $E_{on1}$  is the clamped inductive turn-on-energy of the IGBT only, without the effect of a commutating diode reverse recovery current adding to the IGBT turn-on loss. (See Figure 24.)
  - ⑤  $E_{on2}$  is the clamped inductive turn-on energy that includes a commutating diode reverse recovery current in the IGBT turn-on switching loss. A Combi device is used for the clamping diode as shown in the  $E_{on2}$  test circuit. (See Figures 21, 22.)
  - ⑥  $E_{off}$  is the clamped inductive turn-off energy measured in accordance with JEDEC standard JESD24-1. (See Figures 21, 23.)
- APT Reserves the right to change, without notice, the specifications and information contained herein.**

# TYPICAL PERFORMANCE CURVES

APT80GP60J

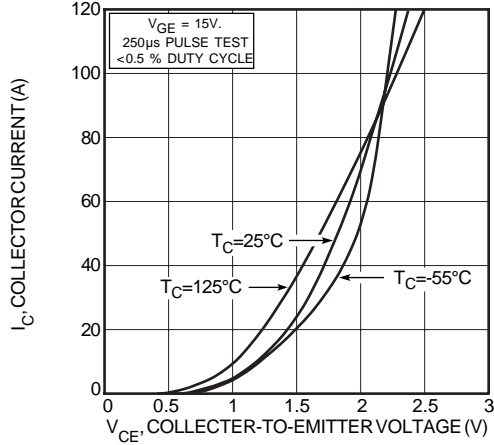

FIGURE 1, Output Characteristics ( $V_{GE} = 15V$ )

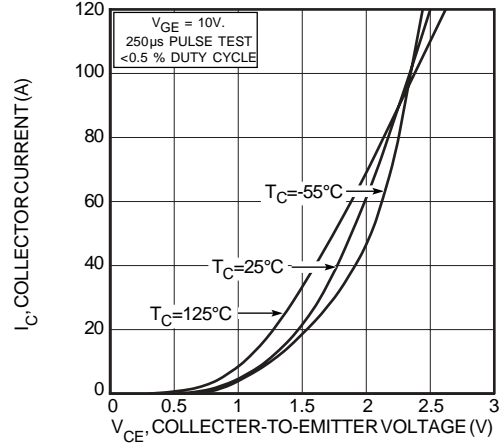

FIGURE 2, Output Characteristics ( $V_{GE} = 10V$ )

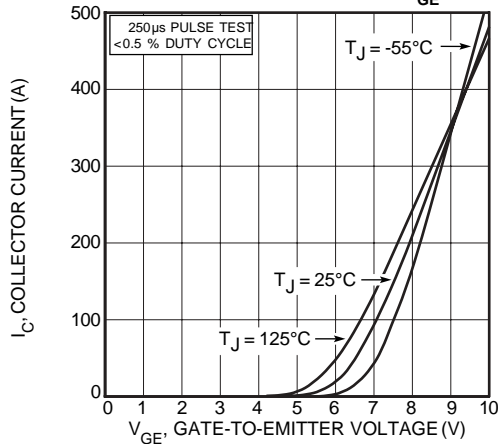

FIGURE 3, Transfer Characteristics

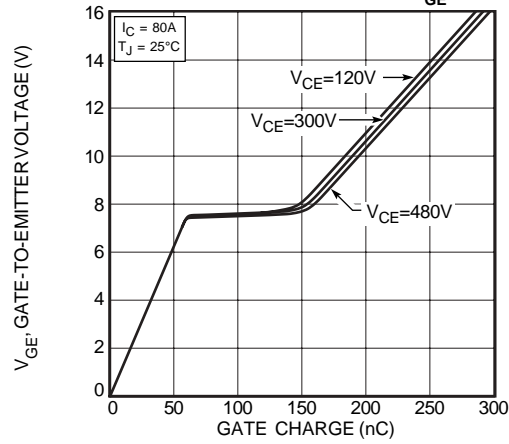

FIGURE 4, Gate Charge

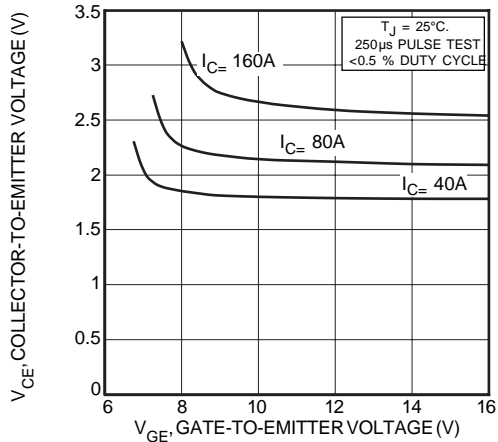

FIGURE 5, On State Voltage vs Gate-to-Emitter Voltage

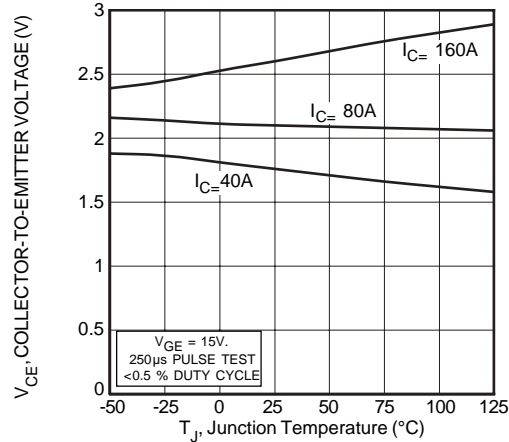

FIGURE 6, On State Voltage vs Junction Temperature

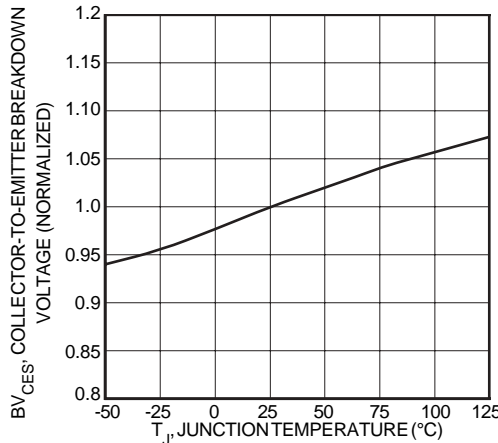

FIGURE 7, Breakdown Voltage vs. Junction Temperature

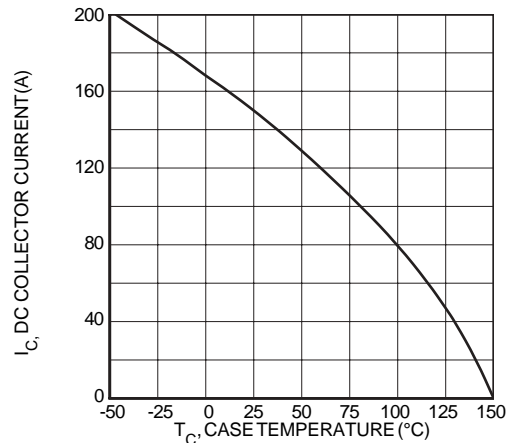

FIGURE 8, DC Collector Current vs Case Temperature

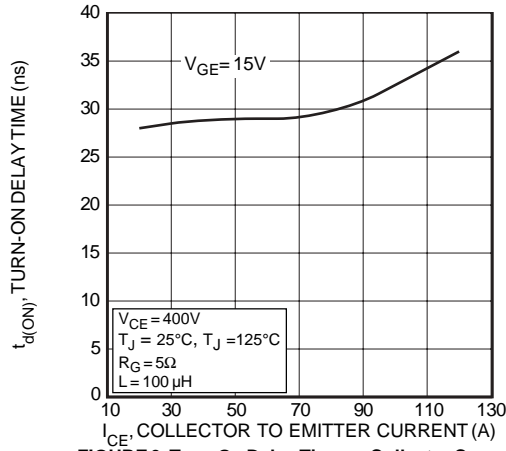

FIGURE 9, Turn-On Delay Time vs Collector Current

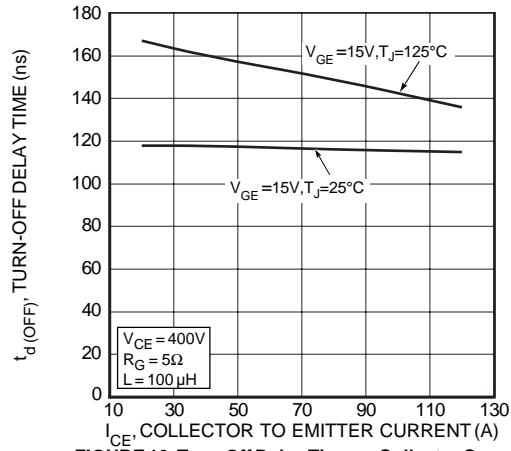

FIGURE 10, Turn-Off Delay Time vs Collector Current

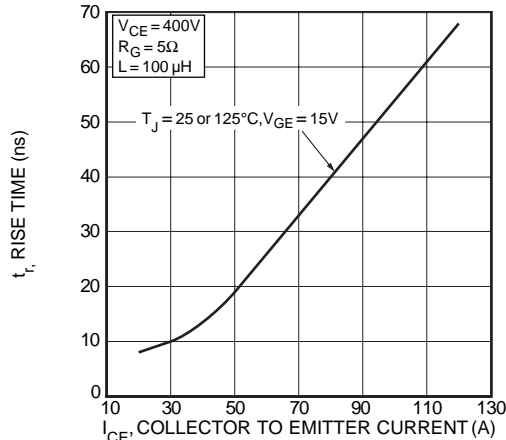

FIGURE 11, Current Rise Time vs Collector Current

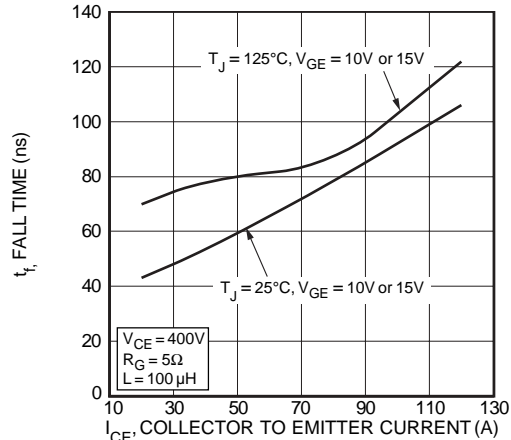

FIGURE 12, Current Fall Time vs Collector Current

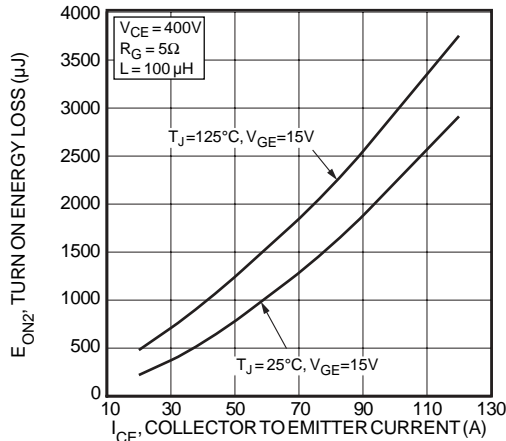

FIGURE 13, Turn-On Energy Loss vs Collector Current

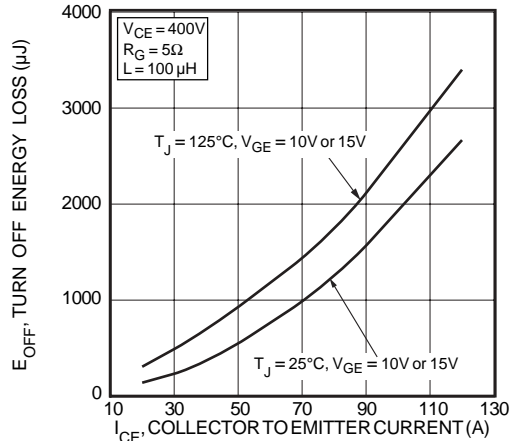

FIGURE 14, Turn Off Energy Loss vs Collector Current

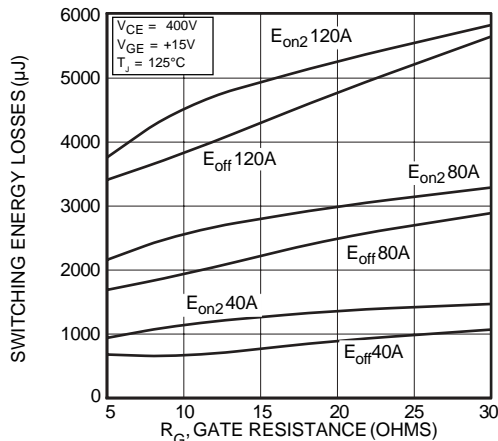

FIGURE 15, Switching Energy Losses vs. Gate Resistance

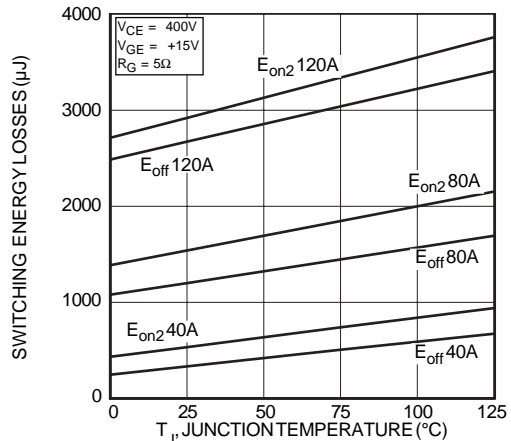

FIGURE 16, Switching Energy Losses vs Junction Temperature

TYPICAL PERFORMANCE CURVES

APT80GP60J

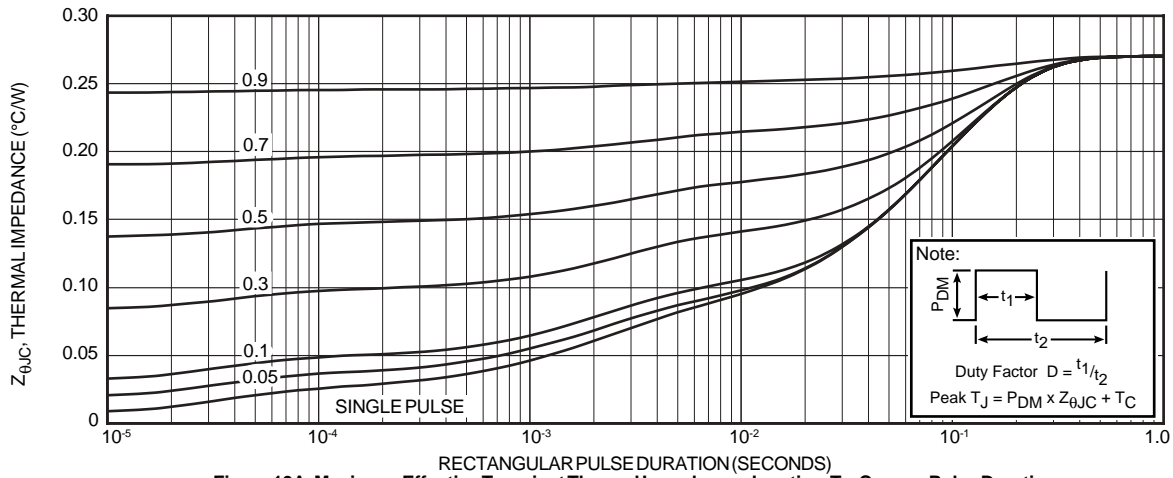
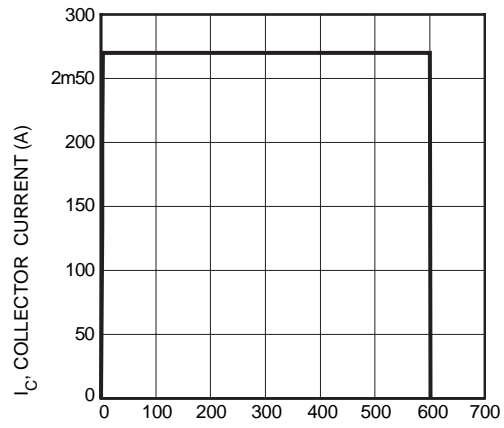
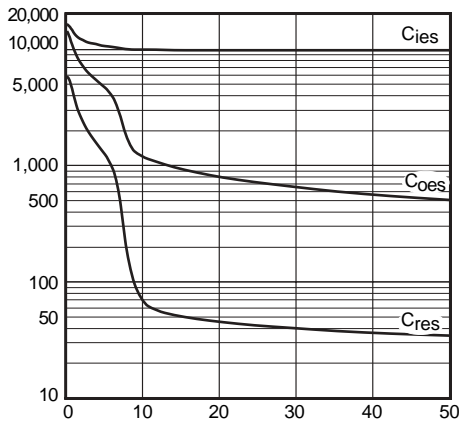

Figure 19A, Maximum Effective Transient Thermal Impedance, Junction-To-Case vs Pulse Duration

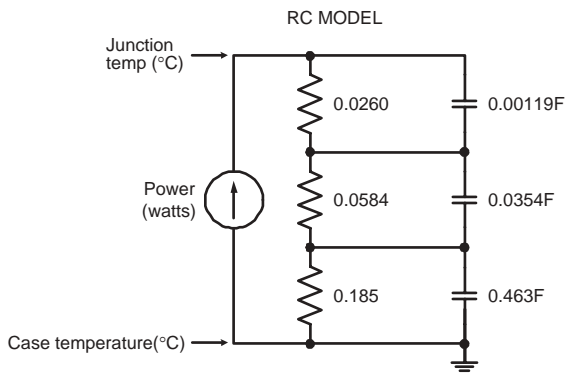

FIGURE 19B, TRANSIENT THERMAL IMPEDANCE MODEL

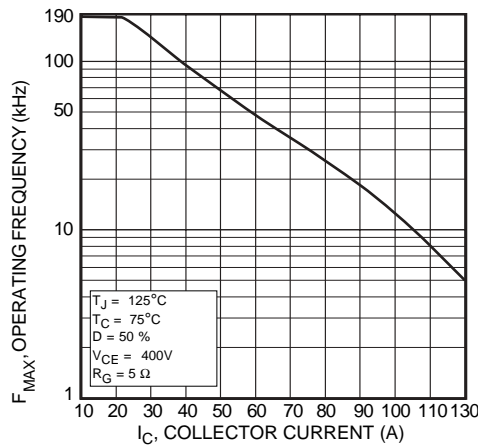

Figure 20, Operating Frequency vs Collector Current

$$F_{max} = \min(f_{max1}, f_{max2})$$

$$f_{max1} = \frac{0.05}{t_{d(on)} + t_r + t_{d(off)} + t_f}$$

$$f_{max2} = \frac{P_{diss} - P_{cond}}{E_{on2} + E_{off}}$$

$$P_{diss} = \frac{T_j - T_c}{R_{\theta JC}}$$

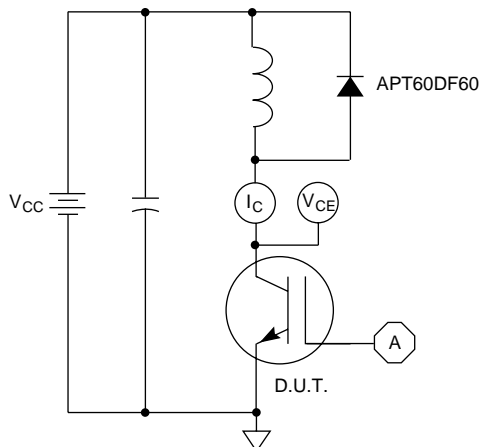

Figure 21, Inductive Switching Test Circuit

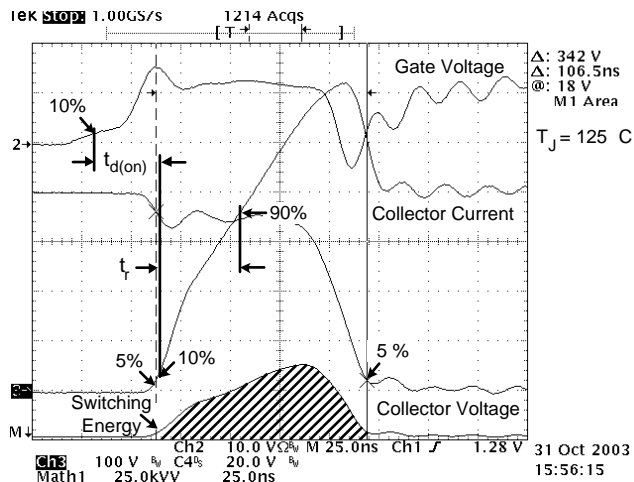

Figure 22, Turn-on Switching Waveforms and Definitions

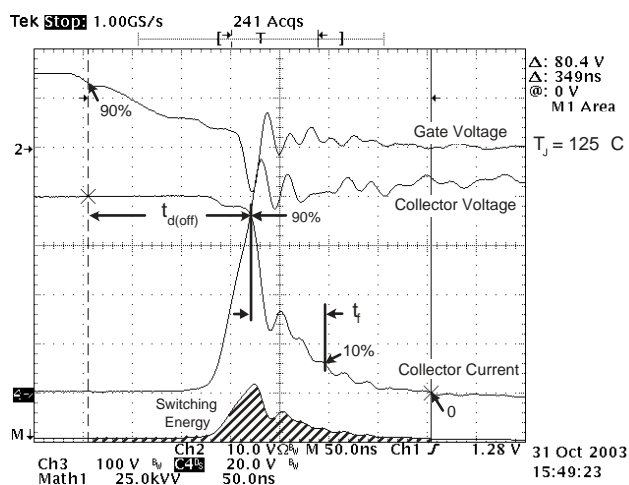

Figure 23, Turn-off Switching Waveforms and Definitions

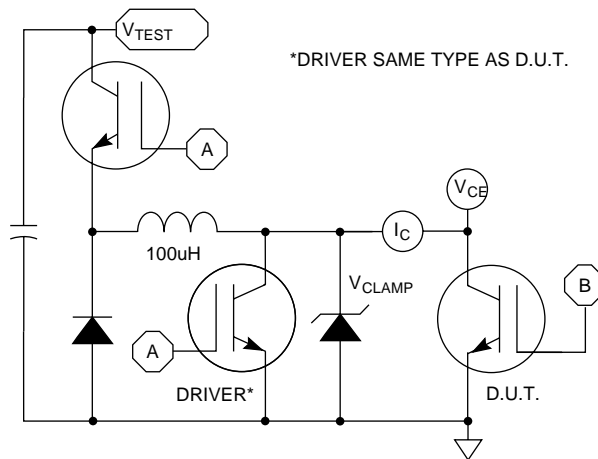
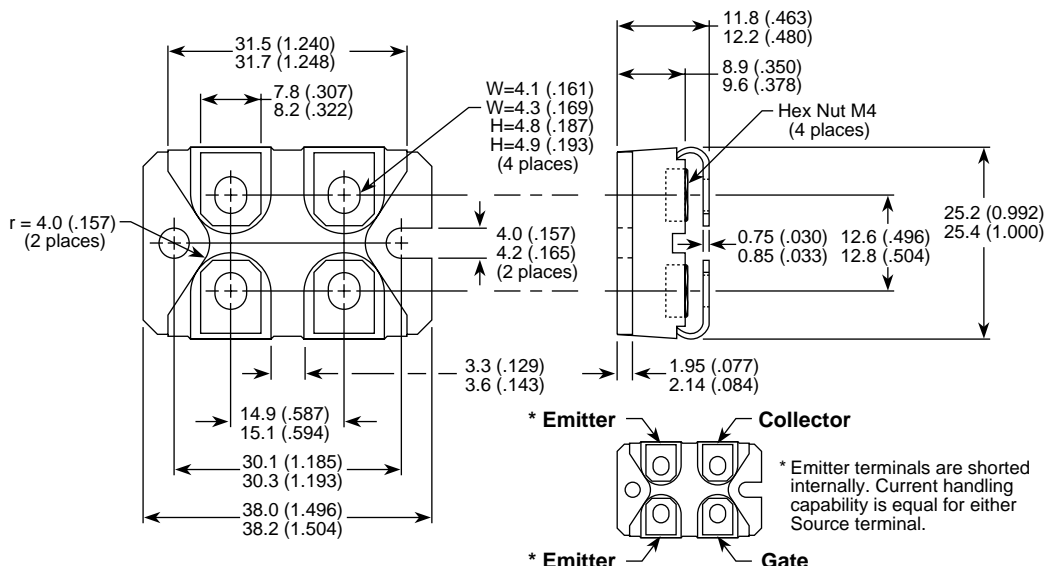

Figure 24, E<sub>ON1</sub> Test Circuit

SOT-227 (ISOTOP®) Package Outline



Dimensions in Millimeters and (Inches)