

XC40E-1203A0A0CBC0

C4000 Select

SAFETY LIGHT CURTAINS

SICK
Sensor Intelligence.

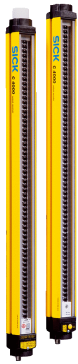

Ordering information

Type	Part no.
XC40E-1203A0A0CBC0	1204169

Other models and accessories → www.sick.com/C4000_Select



Detailed technical data

Features

Protective field height	1,200 mm
Scanning range	0 m ... 19 m
Resolution	30 mm
Response time	≤ 13 ms ¹⁾
Synchronization	Optical synchronisation

¹⁾ Without beam coding, without blanking, no cascaded systems. Other response times see operating instructions.

Safety-related parameters

Type	Type 4 (IEC 61496-1)
Safety integrity level	SIL3 (IEC 61508) SILCL3 (EN 62061)
Category	Category 4 (EN ISO 13849)
Performance level	PL e (EN ISO 13849)
PFH_D (mean probability of a dangerous failure per hour)	3.2 x 10 ⁻⁸ (EN ISO 13849)
T_M (mission time)	20 years (EN ISO 13849)
Safe state in the event of a fault	At least one OSSD is in the OFF state.

Functions

	Functions	Delivery status
Beam coding	✓	Uncoded
Configurable scanning range	✓	

Interfaces

System connection	Connection type	Male connector M12, 5-pin
--------------------------	-----------------	---------------------------

¹⁾ Depending on load, power supply and wire cross-section. The technical specifications must be observed.

²⁾ For additional information on Flexi Soft -> www.sick.com/Flexi_Soft.

Permitted cable length	≤ 30 m ¹⁾
Extension connection	
Connection type	Female connector M12, 5-pin
Position of extension connection	At bottom end cap
Permitted cable length	≤ 10 m
Configuration method	DIP switch
Display elements	7-segment display
Fieldbus, industrial network	
Integration via Flexi Soft safety controller	CANopen, DeviceNet™, EtherCAT®, EtherNet/IP™, Modbus TCP, PROFIBUS DP, PROFINET ²⁾

¹⁾ Depending on load, power supply and wire cross-section. The technical specifications must be observed.

²⁾ For additional information on Flexi Soft -> www.sick.com/Flexi_Soft.

Electrical data

Protection class	III (EN 50178)
Power consumption	≤ 8.4 W
Output signal switching devices (OSSDs)	
Type of output	2 PNP semiconductors, short-circuit protected, cross-circuit monitored
ON state, switching voltage HIGH	24 V DC ($V_S - 2.25 \text{ V DC} \dots V_S$)
OFF state, switching voltage LOW	2 V DC
Current-carrying capacity per OSSD	≤ 500 mA
Switch off time	≥ 100 ms

Mechanical data

Housing material	Aluminum alloy ALMGSI 0.5
-------------------------	---------------------------

Ambient data

Enclosure rating	IP65 (EN 60529)
Ambient operating temperature	0 °C ... +55 °C
Storage temperature	-25 °C ... +70 °C
Air humidity	15 % ... 95 %, Non-condensing
Vibration resistance	5 g, 10 Hz ... 55 Hz (EN 60068-2-6)
Shock resistance	10 g, 16 ms (EN 60068-2-27)

Classifications

ECl@ss 5.0	27272704
ECl@ss 5.1.4	27272704
ECl@ss 6.0	27272704
ECl@ss 6.2	27272704
ECl@ss 7.0	27272704
ECl@ss 8.0	27272704
ECl@ss 8.1	27272704
ECl@ss 9.0	27272704
ETIM 5.0	EC002549
ETIM 6.0	EC002549
UNSPSC 16.0901	46171620

Dimensional drawing (Dimensions in mm (inch))



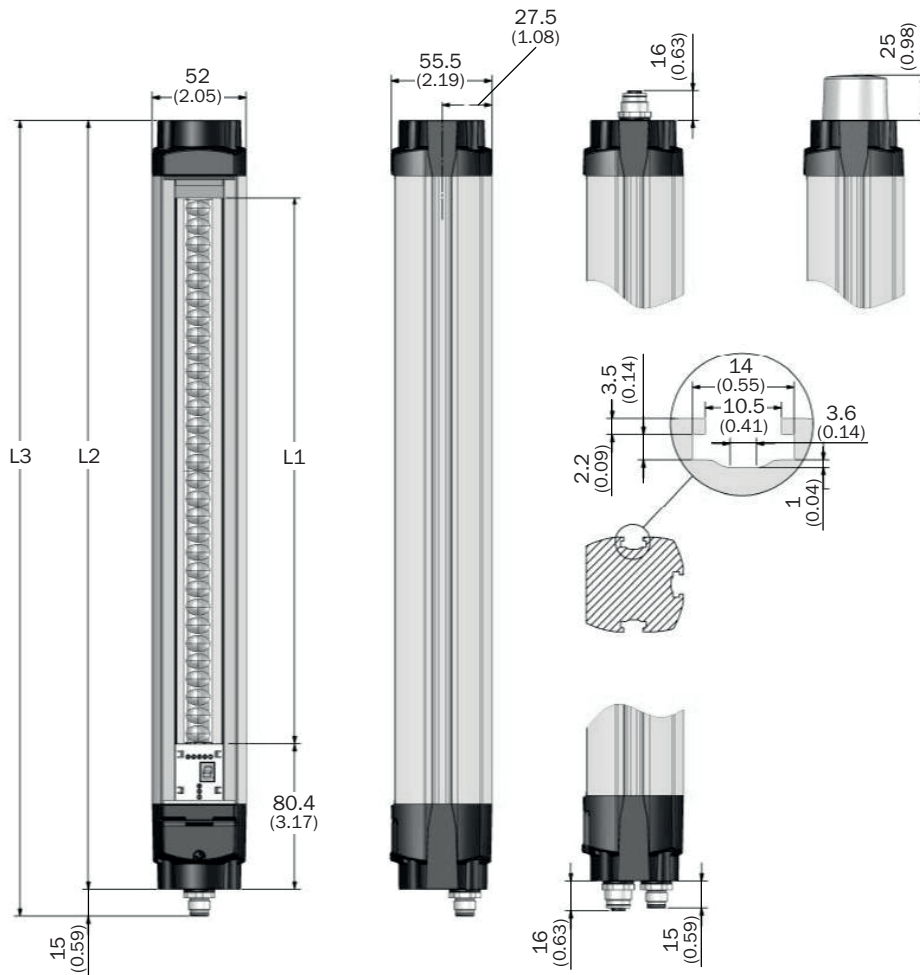

Receiver



Protective field height S	L1	L2	L3
300 (11.81)	302 (11.89)	425 (16.73)	440 (17.32)
450 (17.72)	452 (17.80)	575 (22.64)	590 (23.23)
600 (23.62)	602 (23.70)	725 (28.54)	740 (29.13)
750 (29.53)	752 (29.61)	875 (34.45)	890 (35.04)
900 (35.43)	902 (35.51)	1,025 (40.35)	1,040 (40.94)
1,050 (41.34)	1,052 (41.42)	1,175 (46.26)	1,190 (46.85)
1,200 (47.24)	1,202 (47.32)	1,325 (52.17)	1,340 (52.76)
1,350 (53.15)	1,352 (53.23)	1,475 (58.07)	1,490 (58.66)
1,500 (59.06)	1,502 (59.13)	1,625 (63.98)	1,640 (64.57)
1,650 (64.96)	1,652 (65.04)	1,775 (69.88)	1,790 (70.47)
1,800 (70.87)	1,802 (70.94)	1,925 (75.79)	1,940 (76.38)

Recommended accessories

Other models and accessories → www.sick.com/C4000_Select

	Brief description	Type	Part no.
Mounting brackets and plates			
	4 pieces, Mounting kit 1, mounting bracket, rigid, L-shaped, including fixing screws and washers	BEF-3WNGBAST4	7021352
Terminal and alignment brackets			
	4 pieces, Mounting kit 6, side bracket, rotatable, Zinc diecast	BEF-1SHABAZN4	2019506
	4 pieces, Mounting kit 12, rotatable, swivel mount	BEF-2SMGEAKU4	2030510
Plug connectors and cables			
	Head A: female connector, M12, 5-pin, straight, A-coded Head B: male connector, M12, 5-pin, straight, A-coded Cable: Sensor/actuator cable, PUR, halogen-free, unshielded, 2 m	YF2A15-020UB5M2A15	2096009
Alignment aids			
	Laser alignment aid for various sensors, laser class 2 (IEC 60825). Do not look into the beam!	AR60	1015741

SICK AT A GLANCE

SICK is one of the leading manufacturers of intelligent sensors and sensor solutions for industrial applications. A unique range of products and services creates the perfect basis for controlling processes securely and efficiently, protecting individuals from accidents and preventing damage to the environment.

We have extensive experience in a wide range of industries and understand their processes and requirements. With intelligent sensors, we can deliver exactly what our customers need. In application centers in Europe, Asia and North America, system solutions are tested and optimized in accordance with customer specifications. All this makes us a reliable supplier and development partner.

Comprehensive services complete our offering: SICK LifeTime Services provide support throughout the machine life cycle and ensure safety and productivity.

For us, that is “Sensor Intelligence.”

WORLDWIDE PRESENCE:

Contacts and other locations –www.sick.com