

THIS DRAWING IS UNPUBLISHED. RELEASED FOR PUBLICATION 2000
 © COPYRIGHT 2000 BY TYCO ELECTRONICS CORPORATION. ALL RIGHTS RESERVED.

LOC	DIST	REVISIONS				
P	LTR	DESCRIPTION	DATE	DWN	APVD	
A1	-	B2	RELEASED AS PER ECR-09-005653	11.MAR.2009	GG	TS

- NOTES:
- 1 MATERIAL: SEE TABLE
 - 2 SURFACE: SEE TABLE
 - 3 VARNISH ON THE INSIDE NOT NECESSARY
 - 4 PACKAGING QUANTITY: 5 PIECES PER BOX

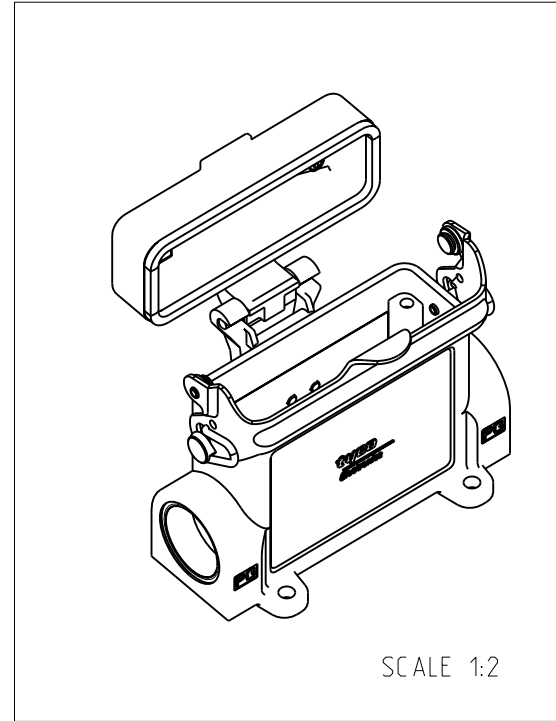
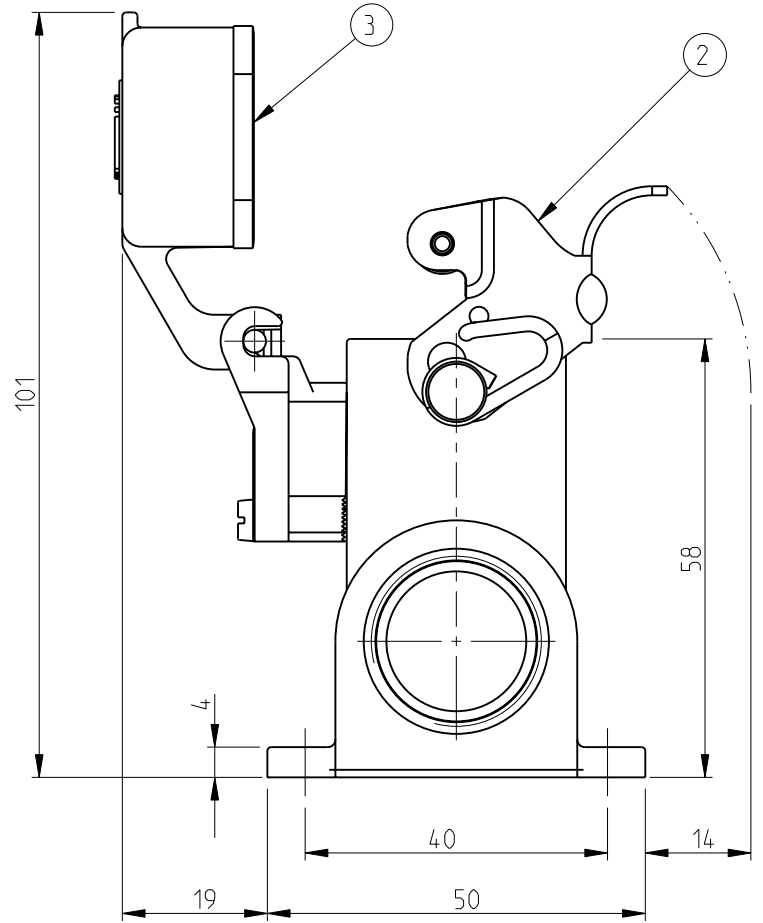
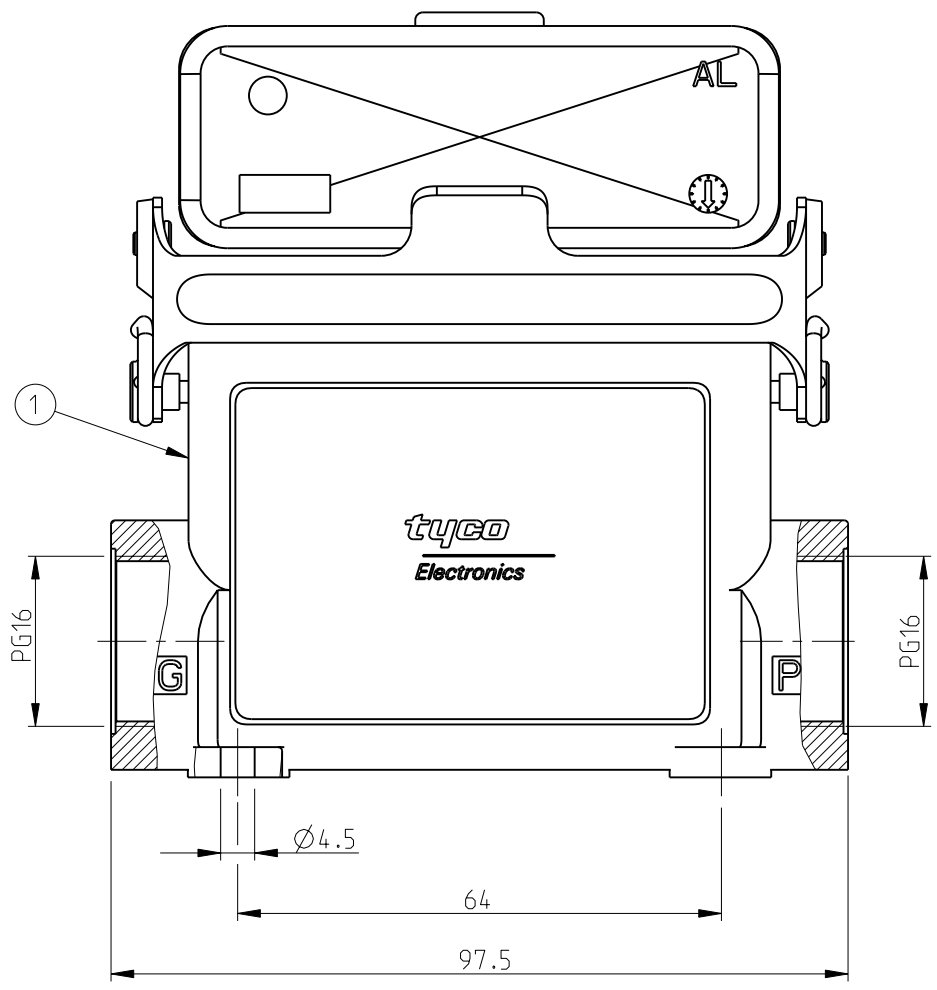

PN 1-2 AS SHOWN

1-2	DESCRIPTION	MATERIAL	SURFACE	COLOR	ITEM NO.	REMARKS
1	COVER	ALUMINIUM	-	GREY	3	
1	CLIP	STEEL	ZINC PLATED	BLUE	2	
1	SURFACE MOUNTED HOUSING-SIDE ENTRY	ALUMINIUM	-	GREY	1	

ORDERING TEXT
 HD25.SGD-LB.2.16.Z

<small>THIS DRAWING IS A CONTROLLED DOCUMENT FOR TYCO ELECTRONICS CORPORATION IT IS SUBJECT TO CHANGE AND THE CONTROLLING ENGINEERING ORGANIZATION SHOULD BE CONTACTED FOR THE LATEST REVISION.</small>		DWN S.KUMAR 4/24/2006 CHK P.BENNUR 4/24/2006 APVD T.SCHNURPFEL 4/24/2006		Tyco Electronics.AMP.GmbH 53757.SanktAugustin.Germany	
DIMENSIONS: mm 		TOLERANCES UNLESS OTHERWISE SPECIFIED: n.ISO 8015: n.ISO 2768-mH-E: n.DIN 16901-120		NAME SURFACE MOUNTED HOUSING SIDE ENTRY HD25.SGD-LB.2.16.Z	
MATERIAL 1		FINISH 2		PRODUCT SPEC 108-74009 APPLICATION SPEC 114-74004 WEIGHT -	
CUSTOMER DRAWING				SIZE A3 CAGE CODE 00779 DRAWING NO C=1102551	RESTRICTED TO - SCALE 1:1 SHEET 1 OF 1 REV B2