

SAC-5P- 5,0-PUR/M12FR

Order No.: 1669877

<http://eshop.phoenixcontact.de/phoenix/treeViewClick.do?UID=1669877>

Sensor/Actuator cable, 5-position, PUR, halogen-free, Black-gray RAL 7021, Free conductor end, on Socket, angled M12, A-coded, Cable length: 5 m

Commercial data	
GTIN (EAN)	 4 017918 134778
sales group	D112
Pack	1 pcs.
Customs tariff	85444290
Catalog page information	Page 87 (PC-2009)

Product notes

WEEE/RoHS-compliant since:
12/01/2005



<http://www.download.phoenixcontact.com>
Please note that the data given here has been taken from the online catalog. For comprehensive information and data, please refer to the user documentation. The General Terms and Conditions of Use apply to Internet downloads.

Technical data	
General data	
Rated current at 40°C	4 A
Rated voltage	60 V
Number of positions	5
Volume resistance	≤ 5 mΩ

Insulation resistance	≥ 100 MΩ
Length of cable	5 m
Stripping length of the free conductor end	50 mm
Ambient temperature (operation)	-25 °C ... 90 °C (Male connector / female connector)

General characteristics

Standards/regulations	M12 connector IEC 61076-2-101
Coding	A - standard
Surge voltage category	II
Pollution degree	3
Degree of protection	IP65/IP68/IP69K
Insertion/withdrawal cycles	≥ 100
Contact material	CuSn
Contact surface material	Ni/Au
Contact carrier material	TPU GF
Material of grip body	TPU, hardly inflammable, self-extinguishing
Material, knurls	Zinc die-cast, (nickel-plated)
Sealing material	NBR
Status display	No

Conductor data

Cable type	PUR halogen-free black
Cable type (abbreviation)	PUR
Conductor cross section	0.34 mm ²
AWG signal line	22
Conductor structure signal line	42x 0.10 mm
Core diameter including insulation	1.27 mm ±0.05 mm
External cable diameter	5.00 mm
Wire colors	brown, blue, white, black, green/yellow
External sheath, color	Black-gray RAL 7021
Outer sheath, material	PUR
Conductor material	Bare Cu litz wires
Cable weight	35 kg/km
Number of bending cycles	4000000
Bending radius	50 mm
Traversing path	10 m

Traversing rate	3 m/s
Acceleration	10 m/s ²
Ambient temperature (operation)	-40 °C ... 80 °C (cable, fixed installation) -5 °C ... 80 °C (cable, flexible installation)
Special properties	Flexible cable conduit capable Silicone-free Free of substances which would hinder coating with paint or varnish
Flame resistance	in accordance with DIN UL-Style 20549
Halogen-free	in accordance with DIN VDE 0472 part 815
Resistance to oil	in accordance with DIN EN 60811-2-1
Other resistance	Highly resistant to acids, alkaline solutions and solvents hydrolysis and microbe resistant

Certificates / Approvals



Certification

CUL Listed, UL Listed

Diagrams/Drawings

Dimensioned drawing

M12 x 1 female connector, angled

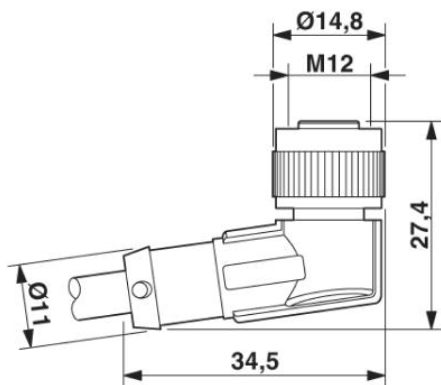

Circuit diagram

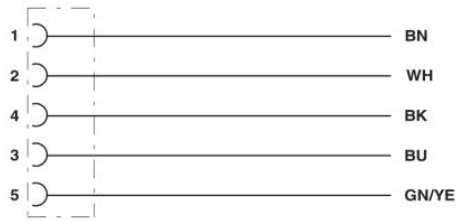

Contact assignment of the M12 sockets

Schematic diagram

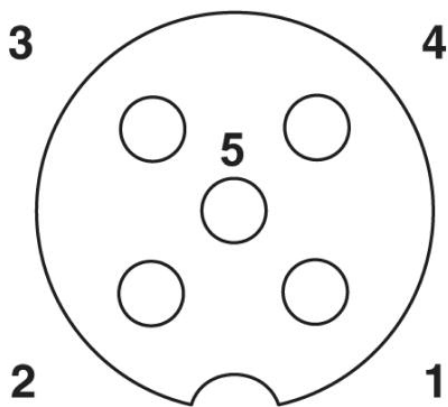

Pin assignment M12 socket, 5-pos., A-coded, socket side view

Address

PHOENIX CONTACT Deutschland GmbH
Flachmarktstr. 8
32825 Blomberg, Germany
Phone +49 5235 3 12000
Fax +49 5235 3 41200
<http://www.phoenixcontact.de>



© 2011 Phoenix Contact
Technical modifications reserved;