

MGA-31289

0.25W High Gain Driver Amplifier

1500 - 3000 MHz



Data Sheet

Description

Avago Technologies MGA-31289 is a 0.25W high gain driver amplifier MMIC with good gain flatness, housed in a standard SOT-89 plastic package. The device features high linearity performance, excellent input and output return loss, and low noise figure. The device can be easily matched to obtain optimum power and linearity.

MGA-31289 is externally tunable to operate within 1.5GHz to 3GHz frequency range applications. With high IP3, low noise figure and wideband operation, MGA-31289 may be utilized as a driver amplifier in the transmit chain and as a second stage LNA in the receive chain.

This device uses Avago Technologies proprietary 0.25um GaAs Enhancement mode PHEMT process.

Pin connections and Package Marking

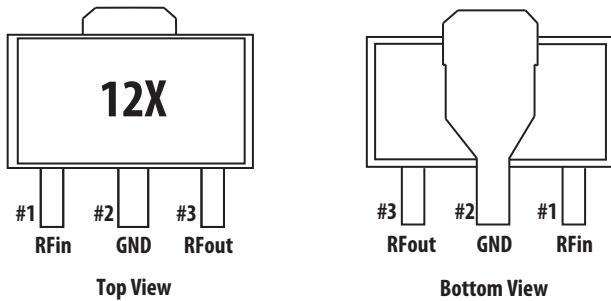

Notes:

Top View : Package marking provides orientation and identification

"12" = Device Code

"X" = Date Code character identifies month of manufacturing



Attention: Observe precautions for handling electrostatic sensitive devices.
ESD Machine Model = 150 V
ESD Human Body Model = 2000 V
Refer to Avago Application Note A004R:
Electrostatic Discharge, Damage and Control.

Features

- ROHS compliant
- Halogen free
- High linearity at low DC bias power ⁽¹⁾
- High Gain
- Good gain flatness
- Low noise figure
- Excellent uniformity in product specification
- SOT-89 standard package

Specifications

At 1.9GHz, Vd = 5V, Id = 124mA (typ) @ 25°C

- OIP3 = 41.8dBm
- Noise Figure = 2dB
- Gain = 18.70dB; Gain Flatness (+/-50MHz) = 0.1dB
- P1dB = 23.6dBm
- IRL = 16.2dB, ORL = 10.3dB

Note:

1. The MGA-31289 has a good LFOM of 14dB. Linearity Figure of Merit (LFOM) is essentially OIP3 divided by DC bias power.

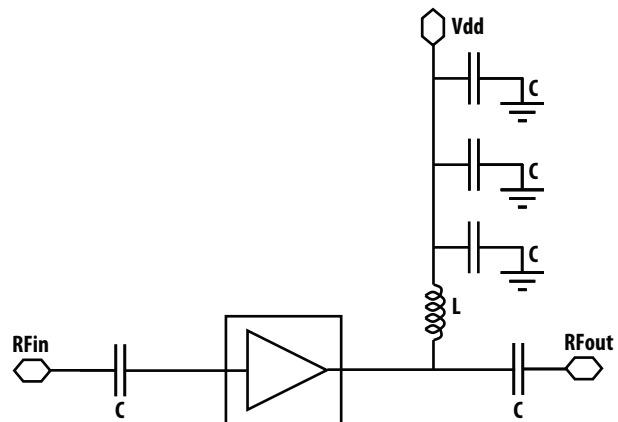

Figure 1. Simplified Schematic diagram

MGA-31289 Absolute Maximum Rating ⁽¹⁾ T_A=25°C

| Symbol | Parameter | Units | Absolute Maximum |
|--------------------|----------------------------------|-------|------------------|
| I _{d,max} | Drain Current | mA | 165 |
| V _{d,max} | Device Voltage | V | 5.5 |
| P _d | Power Dissipation ⁽²⁾ | mW | 907.5 |
| P _{in} | CW RF Input Power | dBm | 25 |
| T _j | Junction Temperature | °C | 150 |
| T _{stg} | Storage Temperature | °C | -65 to 150 |

Thermal Resistance

Thermal Resistance ^[3]
(V_d = 5.0V, T_c = 85°C) θ_{jc} = 50°C/W

Notes:

1. Operation of this device in excess of any of these limits may cause permanent damage.
2. This is limited by maximum V_d and I_d. Board temperature (T_c) is 25°C. For T_c > 104°C, derate the device power at 20mW per °C rise in board temperature adjacent to package bottom.
3. Thermal resistance measured using Infra-Red Microscopy Technique.

MGA-31289 Electrical Specifications ⁽¹⁾

T_A = 25°C, V_d = 5V, unless noted

| Symbol | Parameter and Test Condition | Frequency | Units | Min. | Typ. | Max. |
|---------------------|--------------------------------------|------------------|-------|------|--------------|------|
| I _{ds} | Quiescent current | N/A | mA | 101 | 124 | 143 |
| NF | Noise Figure | 1.9GHz 2.5GHz | dB | - | 2 2 | 2.45 |
| Gain | Gain | 1.9GHz 2.5GHz | dB | 17 | 18.7 17.7 | 20 |
| OIP3 ^[2] | Output Third Order Intercept Point | 1.9GHz 2.5GHz | dBm | 38.2 | 41.8 41.5 | - |
| P1dB | Output Power at 1dB Gain Compression | 1.9GHz 2.5GHz | dBm | 21.8 | 23.6 23.7 | - |
| PAE | Power Added Efficiency at P1dB | 1.9GHz 2.5GHz | % | - | 36.4 34.8 | - |
| IRL | Input Return Loss | 1.9GHz 2.5GHz | dB | - | 16.2 15.5 | - |
| ORL | Output Return Loss | 1.9GHz 2.5GHz | dB | - | 10.3 10.8 | - |
| ISOL | Isolation | 1.9GHz 2.5GHz | dB | - | 27.3 27.7 | - |

Notes:

1. Typical performance obtained from a test circuit described in Figure 25.
2. OIP3 test condition: F1 - F2 = 10MHz, with input power of -10dBm per tone measured at worst case side band.

MGA-31289 Consistency Distribution Chart (1, 2)

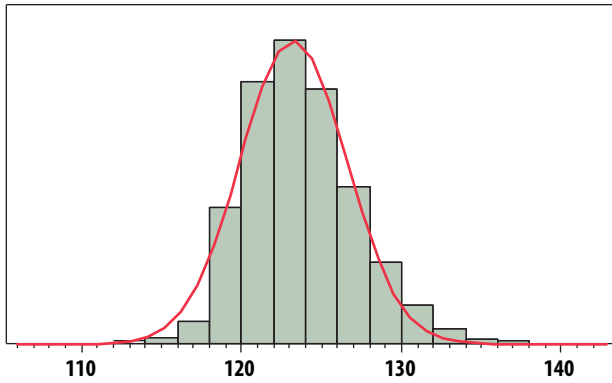

Figure 2. Idd @ 1900MHz, Vdd=5V, LSL=101mA, Nominal=124mA, USL=143mA

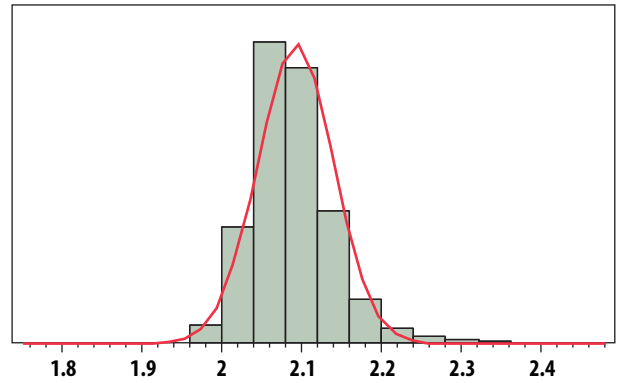

Figure 3. NF @ 900MHz, Vdd = 5V, Nominal=2dB, USL=2.45dB

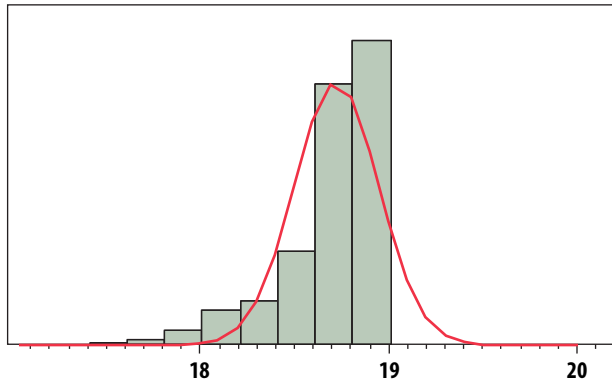

Figure 4. Gain @ 900MHz, Vdd = 5V, LSL=17dB, Nominal=18.7dB, USL=20dB

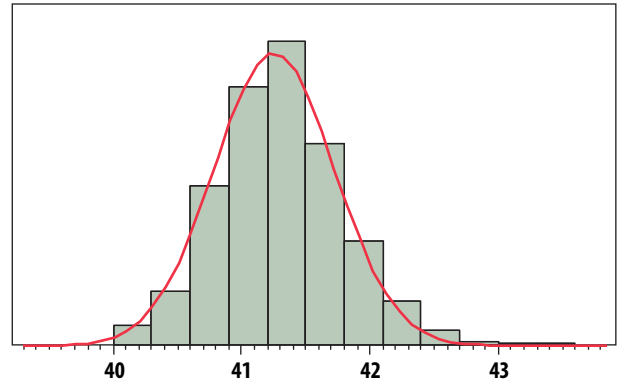

Figure 5. OIP3 @ 900MHz, Vdd = 5V, LSL=38.2, Nominal=41.8dBm

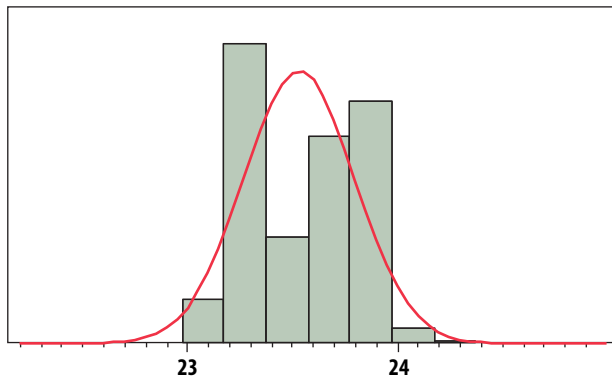

Figure 6. P1dB @ 900MHz, Vdd = 5V, LSL=21.8dBm, Nominal=23.6dBm

Notes:

1. Data sample size is 2800 samples taken from 4 different wafers and 2 different lots. Future wafers allocated to this product may have nominal values anywhere between the upper and lower limits.
2. Measurements are made on production test board which represents a trade-off between optimal Gain, NF, OIP3 and OP1dB. Circuit losses have been de-embedded from actual measurements.

MGA-31289 Application Circuit Data for 1900MHz

$T_A = 25^\circ\text{C}$, $V_d = 5.0\text{V}$, $I_d = 124\text{mA}$

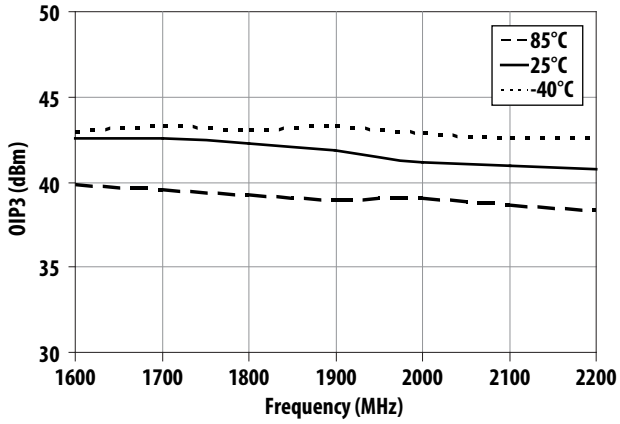

Figure 7. OIP3 vs Frequency and Temperature

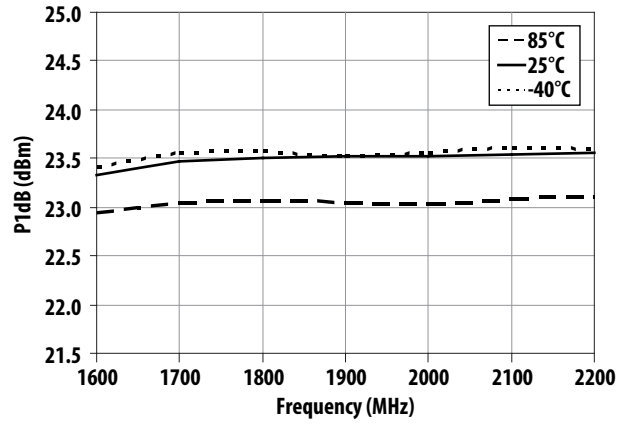

Figure 8. P1dB vs Frequency and Temperature

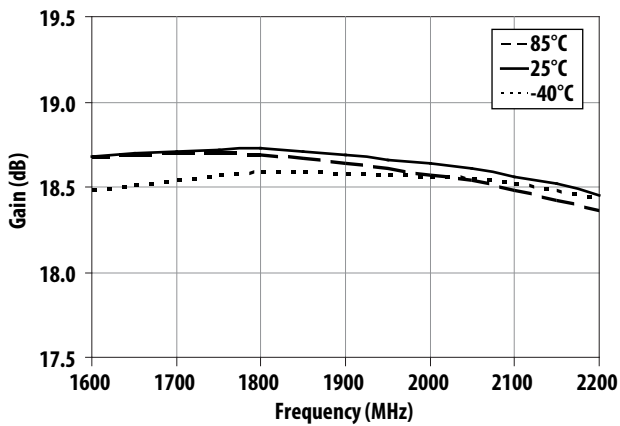

Figure 9. Gain vs Frequency and Temperature

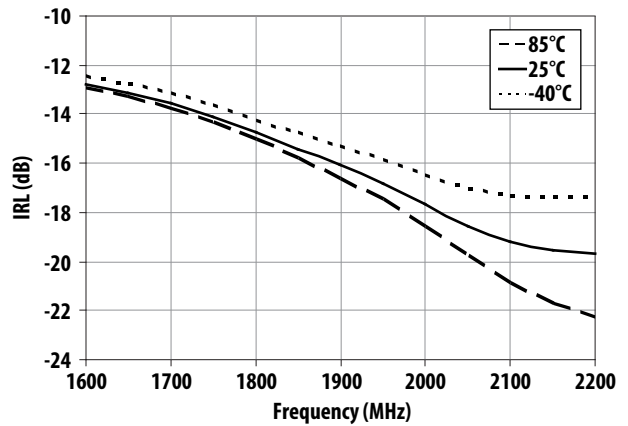

Figure 10. IRL vs Frequency and Temperature

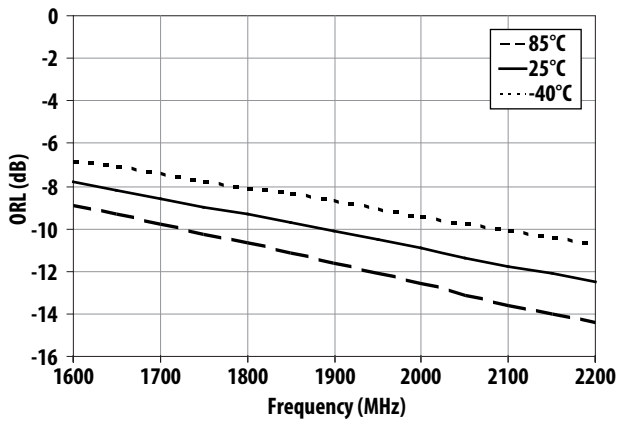

Figure 11. ORL vs Frequency and Temperature

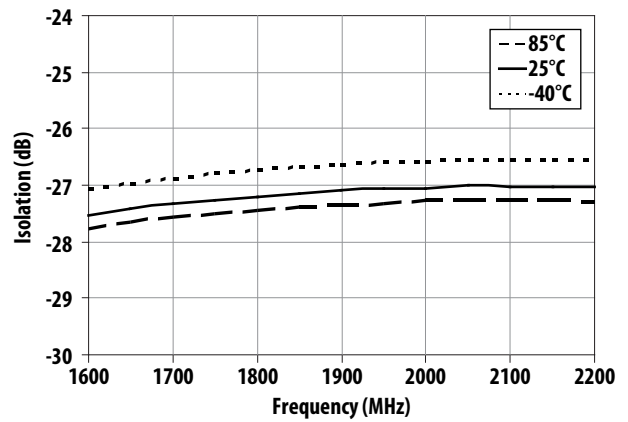

Figure 12. Isolation vs Frequency and Temperature

MGA-31289 Application Circuit Data for 1900MHz (continue)

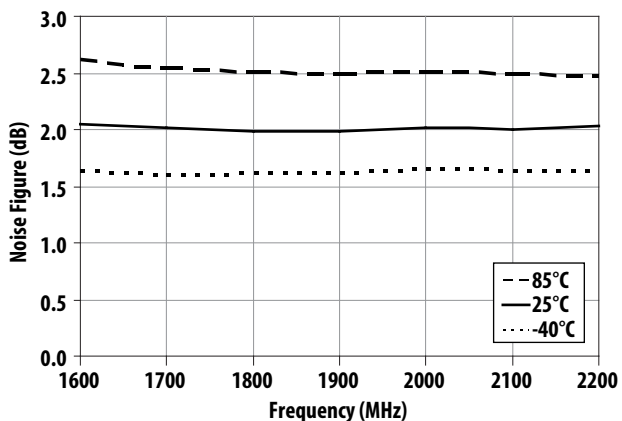

Figure 13. Noise Figure vs Frequency and Temperature

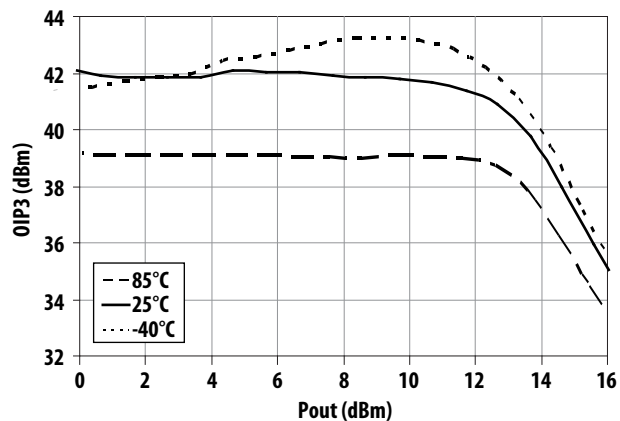

Figure 14. OIP3 vs Output Power and Temperature

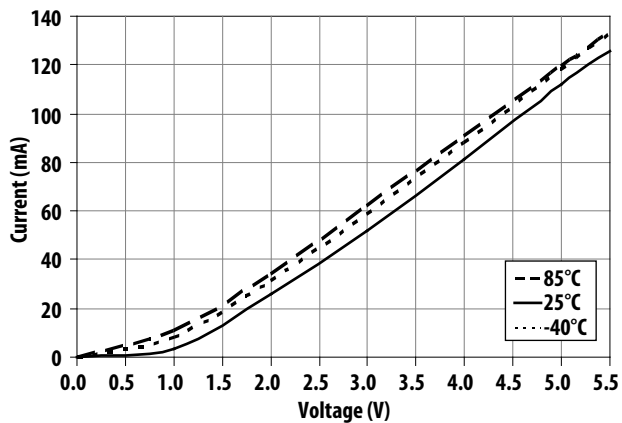

Figure 15. Current vs Voltage and Temperature

MGA-31289 Application Circuit Data for 2500MHz

$T_A = 25^\circ\text{C}$, $V_d = 5.0\text{V}$, $I_d = 124\text{mA}$

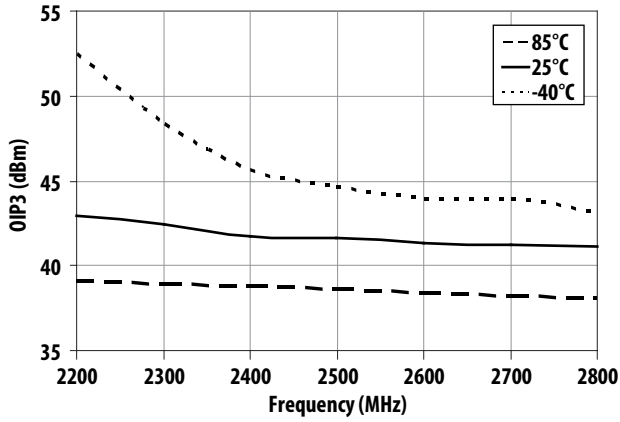

Figure 16. OIP3 vs Frequency and Temperature

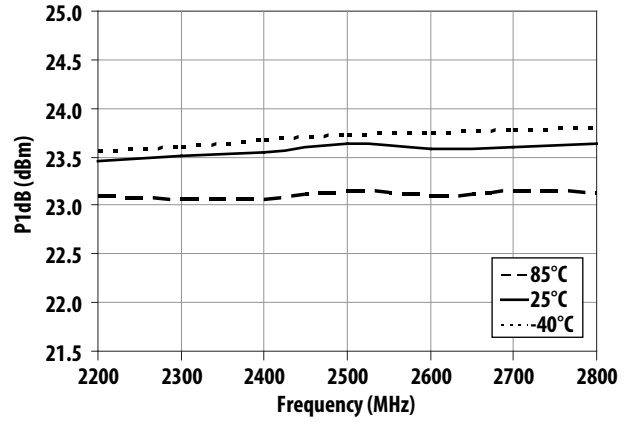

Figure 17. P1dB vs Frequency and Temperature

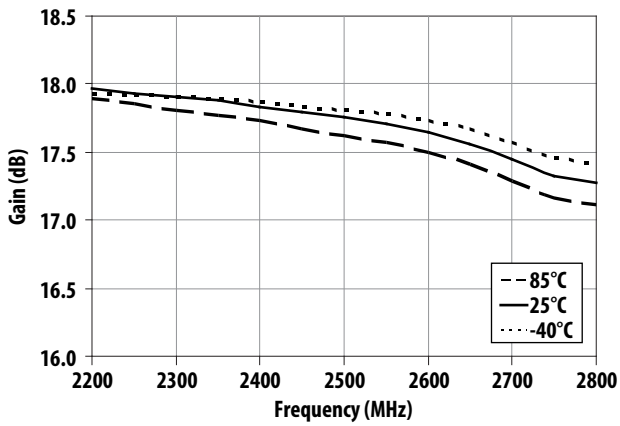

Figure 18. Gain vs Frequency and Temperature

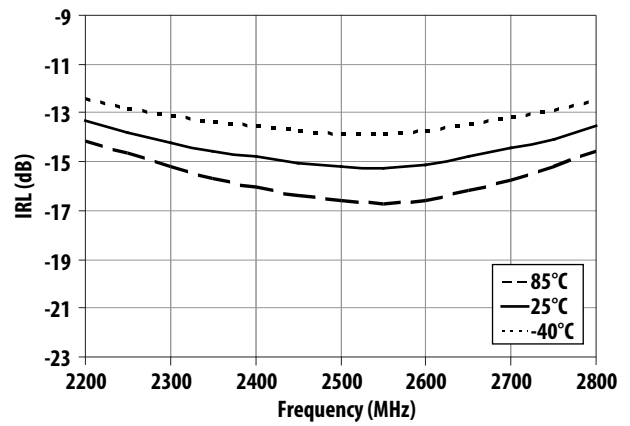

Figure 19. IRL vs Frequency and Temperature

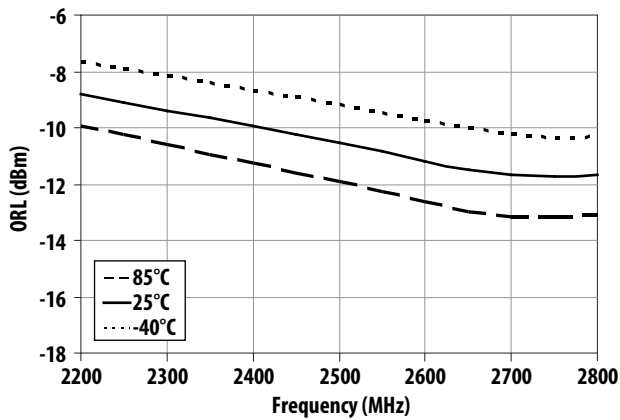

Figure 20. ORL vs Frequency and Temperature

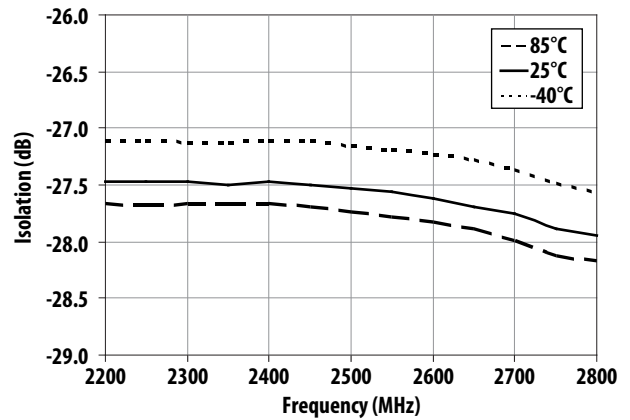

Figure 21. Isolation vs Frequency and Temperature

MGA-31289 Application Circuit Data for 2500MHz (continue)

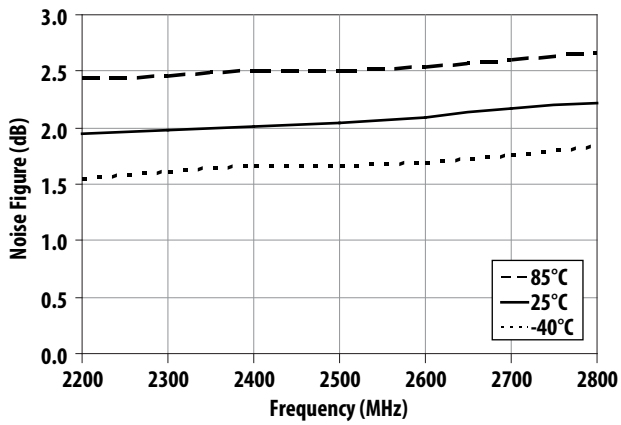

Figure 22. Noise Figure vs Frequency and Temperature

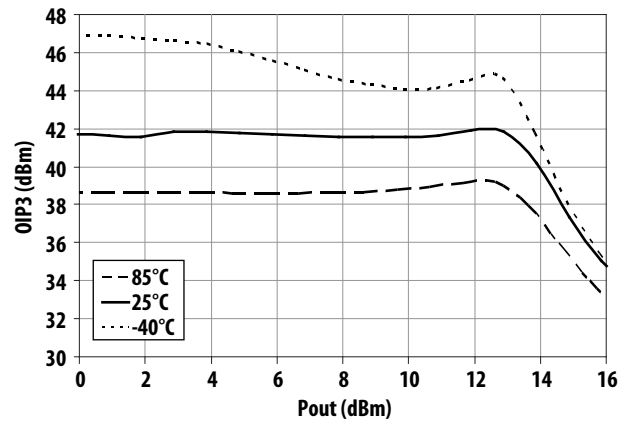

Figure 23. OIP3 vs Output Power and Temperature

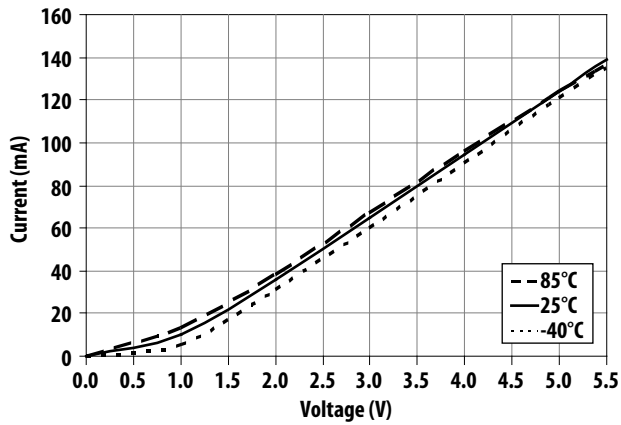

Figure 24. Current vs Voltage and Temperature

Application Circuit Description and Layout

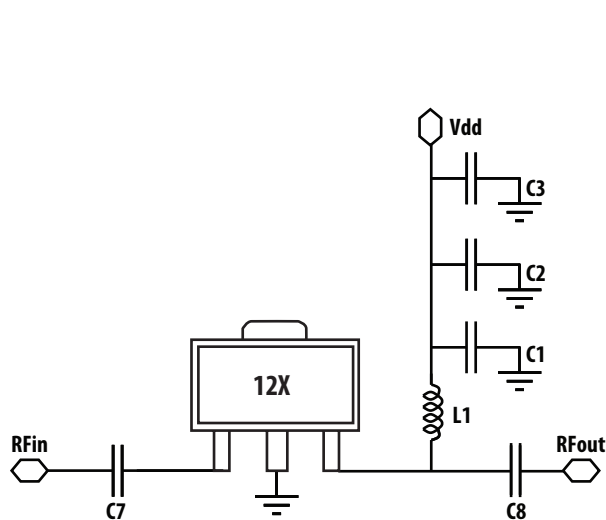

Figure 25. Circuit diagram

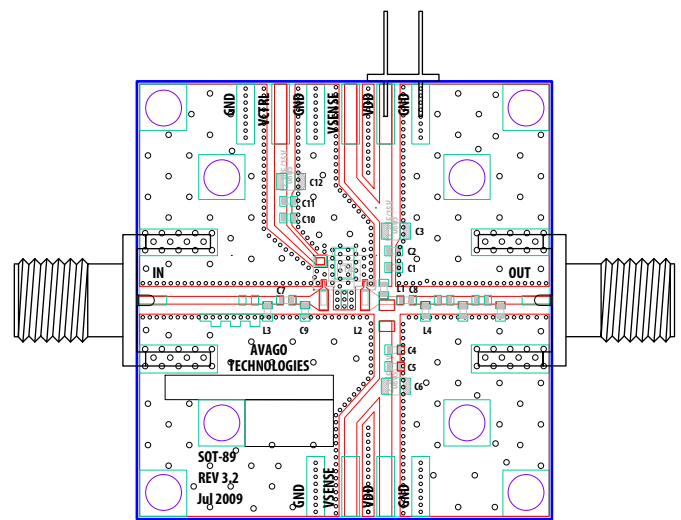

Figure 26. Demoboard

Bill of Materials

| Circuit Symbol | Size | Description | | Description | |
|----------------|------|---------------------------|--------------|---------------------------|--------------|
| | | For 1.9GHz ⁽¹⁾ | | For 2.5GHz ⁽²⁾ | |
| | | Value | Manufacturer | Value | Manufacturer |
| C1 | 0402 | 3.9pF | Murata | 2.7pF | Murata |
| C2 | 0402 | 0.1μF | Murata | 0.1μF | Murata |
| C3 | 0603 | 2.2μF | Murata | 2.2μF | Murata |
| C7 | 0402 | 10pF | Murata | 100pF | Murata |
| C8 | 0402 | 100pF | Murata | 100pF | Murata |
| L1 | 0402 | 5.6nH | Murata | 3.3nH | Toko |

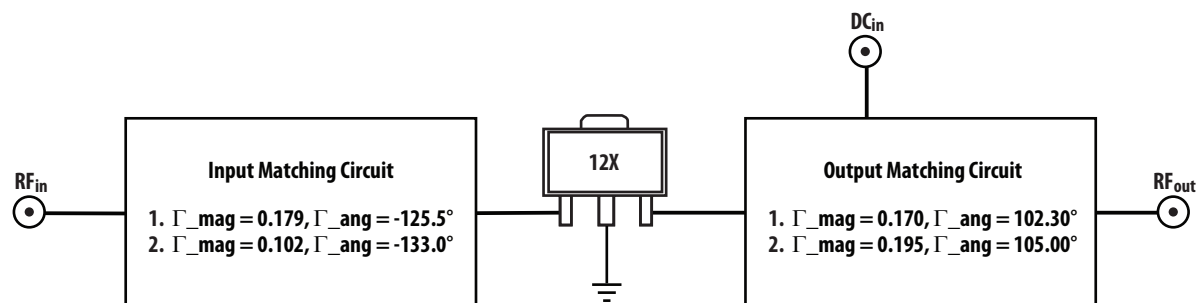

Figure 27. Input and output tuned Gamma location for 1900MHz⁽¹⁾, 2500MHz⁽²⁾

MGA-31289 is an input and output prematched driver amplifier. To bias MGA-31289, a +5V supply (Vdd) is connected to the output pin through a RF choke, L1 (which isolates the inband signal from the DC supply). The bypass capacitors (C1, C2 and C3) help to eliminate out of band low frequency signals from the power supply. Blocking capacitors are required for its input (C7) and output (C8), to isolate the supply voltage from preceding and succeeding circuits. C7 also plays a part in input tuning to improve input return loss while L1 and C8 help in output matching. The recommended output tuning is for achieving best OIP3, while meeting typical specifications for other parameters.

MGA-31289 Typical Scatter Parameters (1)

$T_A = 25^\circ\text{C}$, $V_d = 5.0\text{V}$, $I_d = 124\text{mA}$, $Z_o = 50\Omega$

| Freq GHz | S11 | S11 | S11 | S21 | S21 | S21 | S12 | S12 | S12 | S22 | S22 | S22 | K |
|-------------|------|---------|--------|------|---------|--------|------|---------|--------|------|---------|--------|--------|
| | Mag. | Ang. | dB | Mag. | Ang. | dB | Mag. | Ang. | dB | Mag. | Ang. | dB | |
| 0.05 | 0.90 | 176.00 | -0.96 | 0.10 | -138.44 | -20.42 | 0.00 | 50.02 | -66.94 | 0.83 | 177.77 | -1.58 | 706.23 |
| 0.10 | 0.89 | 172.37 | -0.97 | 0.14 | -111.67 | -17.33 | 0.00 | 116.16 | -66.79 | 0.83 | 173.32 | -1.63 | 502.64 |
| 0.20 | 0.89 | 164.77 | -0.98 | 0.30 | -84.22 | -10.47 | 0.00 | 118.26 | -56.73 | 0.82 | 165.72 | -1.68 | 73.92 |
| 0.30 | 0.89 | 156.86 | -0.98 | 0.58 | -76.20 | -4.71 | 0.00 | 117.54 | -52.01 | 0.82 | 158.16 | -1.75 | 22.90 |
| 0.40 | 0.89 | 148.34 | -1.04 | 1.00 | -77.36 | 0.01 | 0.00 | 121.16 | -47.32 | 0.80 | 150.04 | -1.92 | 9.07 |
| 0.50 | 0.87 | 139.08 | -1.20 | 1.58 | -83.18 | 3.96 | 0.01 | 118.98 | -43.55 | 0.78 | 141.53 | -2.21 | 4.87 |
| 0.60 | 0.85 | 128.94 | -1.45 | 2.33 | -91.97 | 7.36 | 0.01 | 114.39 | -40.18 | 0.74 | 132.45 | -2.63 | 3.15 |
| 0.70 | 0.81 | 117.74 | -1.85 | 3.29 | -103.03 | 10.35 | 0.01 | 107.35 | -37.13 | 0.69 | 122.65 | -3.23 | 2.32 |
| 0.80 | 0.74 | 105.37 | -2.56 | 4.41 | -116.67 | 12.88 | 0.02 | 97.31 | -34.43 | 0.62 | 112.37 | -4.17 | 1.93 |
| 0.90 | 0.66 | 91.69 | -3.57 | 5.70 | -131.64 | 15.12 | 0.02 | 86.32 | -32.10 | 0.53 | 101.71 | -5.46 | 1.67 |
| 1.00 | 0.55 | 75.92 | -5.20 | 7.02 | -148.43 | 16.92 | 0.03 | 72.97 | -30.15 | 0.43 | 91.88 | -7.26 | 1.52 |
| 1.10 | 0.42 | 60.05 | -7.61 | 8.16 | -166.16 | 18.24 | 0.04 | 58.73 | -28.65 | 0.33 | 85.01 | -9.71 | 1.42 |
| 1.20 | 0.28 | 46.84 | -11.11 | 9.02 | 176.38 | 19.11 | 0.04 | 44.57 | -27.60 | 0.23 | 85.96 | -12.83 | 1.35 |
| 1.30 | 0.15 | 40.60 | -16.49 | 9.52 | 159.78 | 19.57 | 0.04 | 30.96 | -26.99 | 0.17 | 99.47 | -15.48 | 1.31 |
| 1.40 | 0.06 | 68.58 | -24.49 | 9.73 | 144.35 | 19.76 | 0.05 | 18.40 | -26.63 | 0.16 | 118.54 | -15.78 | 1.29 |
| 1.50 | 0.08 | 130.90 | -21.79 | 9.72 | 130.34 | 19.75 | 0.05 | 7.30 | -26.47 | 0.19 | 128.54 | -14.54 | 1.28 |
| 1.60 | 0.14 | 136.84 | -17.07 | 9.60 | 117.63 | 19.65 | 0.05 | -2.92 | -26.42 | 0.22 | 130.13 | -13.30 | 1.27 |
| 1.70 | 0.19 | 131.02 | -14.59 | 9.44 | 106.04 | 19.50 | 0.05 | -11.91 | -26.42 | 0.24 | 128.12 | -12.45 | 1.28 |
| 1.80 | 0.22 | 122.69 | -13.16 | 9.25 | 95.27 | 19.32 | 0.05 | -20.35 | -26.49 | 0.25 | 124.62 | -11.92 | 1.29 |
| 1.90 | 0.24 | 113.45 | -12.34 | 9.07 | 85.05 | 19.15 | 0.05 | -28.34 | -26.53 | 0.26 | 120.23 | -11.62 | 1.30 |
| 2.00 | 0.25 | 103.97 | -11.91 | 8.90 | 75.52 | 18.99 | 0.05 | -35.86 | -26.57 | 0.26 | 116.00 | -11.54 | 1.32 |
| 2.10 | 0.26 | 94.33 | -11.80 | 8.74 | 66.20 | 18.83 | 0.05 | -43.36 | -26.62 | 0.26 | 111.82 | -11.61 | 1.34 |
| 2.20 | 0.25 | 84.30 | -11.91 | 8.62 | 57.25 | 18.71 | 0.05 | -50.50 | -26.67 | 0.26 | 108.07 | -11.80 | 1.36 |
| 2.30 | 0.24 | 73.82 | -12.28 | 8.50 | 48.53 | 18.59 | 0.05 | -57.61 | -26.70 | 0.25 | 104.90 | -12.13 | 1.38 |
| 2.40 | 0.23 | 62.53 | -12.90 | 8.39 | 39.82 | 18.48 | 0.05 | -64.62 | -26.71 | 0.24 | 102.10 | -12.55 | 1.40 |
| 2.50 | 0.21 | 49.87 | -13.76 | 8.31 | 31.19 | 18.40 | 0.05 | -71.78 | -26.79 | 0.22 | 100.25 | -13.07 | 1.43 |
| 3.00 | 0.15 | -74.29 | -16.40 | 7.88 | -12.75 | 17.93 | 0.04 | -110.43 | -27.21 | 0.16 | 111.26 | -15.72 | 1.58 |
| 3.50 | 0.43 | -153.06 | -7.29 | 6.93 | -58.47 | 16.82 | 0.04 | -153.19 | -28.67 | 0.20 | 122.05 | -14.18 | 1.74 |
| 4.00 | 0.67 | 169.43 | -3.45 | 5.60 | -102.14 | 14.96 | 0.03 | 165.03 | -31.05 | 0.14 | 104.95 | -16.88 | 1.87 |
| 5.00 | 0.86 | 114.66 | -1.33 | 3.19 | 172.85 | 10.08 | 0.02 | 88.83 | -35.38 | 0.27 | -135.43 | -11.34 | 2.22 |
| 6.00 | 0.89 | 50.49 | -0.99 | 1.38 | 97.47 | 2.80 | 0.01 | 29.19 | -36.53 | 0.38 | 149.37 | -8.50 | 4.15 |
| 7.00 | 0.95 | 2.17 | -0.47 | 0.54 | 46.58 | -5.35 | 0.01 | -15.36 | -37.36 | 0.39 | 94.75 | -8.16 | 5.84 |
| 8.00 | 0.98 | -14.05 | -0.16 | 0.27 | 8.81 | -11.26 | 0.01 | -43.35 | -37.75 | 0.47 | 66.73 | -6.62 | 4.09 |
| 9.00 | 0.96 | -31.89 | -0.32 | 0.16 | -32.27 | -15.96 | 0.01 | -72.38 | -37.87 | 0.56 | 37.77 | -5.04 | 12.09 |
| 10.00 | 0.94 | -70.89 | -0.58 | 0.08 | -80.93 | -21.60 | 0.01 | -108.98 | -39.92 | 0.62 | -0.96 | -4.08 | 45.84 |
| 11.00 | 0.95 | -102.69 | -0.40 | 0.03 | -121.56 | -29.74 | 0.00 | -141.20 | -46.39 | 0.72 | -40.39 | -2.83 | 136.26 |
| 12.00 | 0.97 | -115.91 | -0.25 | 0.01 | -144.08 | -39.18 | 0.00 | -147.56 | -62.59 | 0.81 | -63.12 | -1.87 | 1194.5 |
| 13.00 | 0.97 | -125.32 | -0.27 | 0.00 | -147.91 | -51.96 | 0.00 | -2.63 | -53.49 | 0.83 | -81.81 | -1.65 | 1771.7 |
| 14.00 | 0.96 | -145.29 | -0.38 | 0.00 | -44.69 | -49.13 | 0.01 | -31.64 | -45.86 | 0.82 | -104.80 | -1.69 | 764.55 |
| 15.00 | 0.96 | -170.76 | -0.31 | 0.01 | -63.24 | -44.11 | 0.01 | -59.47 | -43.55 | 0.83 | -131.82 | -1.59 | 259.48 |
| 16.00 | 0.97 | 175.48 | -0.22 | 0.00 | -87.63 | -46.38 | 0.00 | -84.21 | -46.39 | 0.85 | -151.51 | -1.37 | 292.24 |
| 17.00 | 0.96 | 167.92 | -0.31 | 0.00 | -60.01 | -52.59 | 0.00 | -55.23 | -52.88 | 0.87 | -162.58 | -1.24 | 1617.9 |
| 18.00 | 0.95 | 158.60 | -0.45 | 0.01 | -20.69 | -45.67 | 0.01 | -18.78 | -45.62 | 0.87 | -169.97 | -1.24 | 445.59 |
| 19.00 | 0.93 | 140.29 | -0.65 | 0.01 | -16.45 | -41.90 | 0.01 | -15.28 | -42.15 | 0.84 | 179.75 | -1.52 | 327.89 |
| 20.00 | 0.95 | 118.62 | -0.48 | 0.01 | -17.88 | -39.82 | 0.01 | -16.56 | -39.80 | 0.82 | 161.97 | -1.73 | 163.82 |

MGA-31289 K-Factor (1)

$T_A = 25^\circ\text{C}$, $V_d = 5.0\text{V}$, $I_d = 124\text{mA}$, $Z_o = 50\Omega$

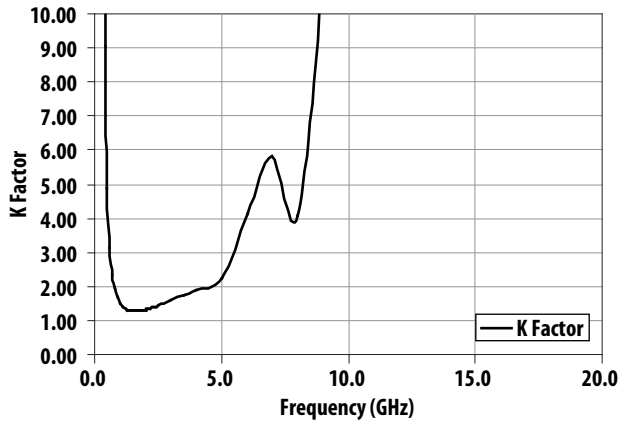

MGA-31289 Typical Noise Parameters (1)

$T_A = 25^\circ\text{C}$, $V_d = 5.0\text{V}$, $I_d = 124\text{mA}$, $Z_o = 50\Omega$

| Freq (GHz) | F_{min} (dB) | Γ_{opt} Mag | Γ_{opt} Ang | R_n/Z_o | Ga (dB) |
|------------|----------------|--------------------|--------------------|-----------|---------|
| 0.5 | 7.27 | 0.82 | -142 | 1.49 | 13.48 |
| 0.8 | 3.35 | 0.64 | -119.4 | 0.59 | 17.91 |
| 0.9 | 3.24 | 0.537 | -113.3 | 0.52 | 18.58 |
| 1 | 2.98 | 0.497 | -103.1 | 0.48 | 19.17 |
| 1.5 | 2.2 | 0.225 | -83.1 | 0.29 | 19.90 |
| 2 | 2.08 | 0.077 | -92.9 | 0.23 | 19.30 |
| 2.5 | 1.93 | 0.096 | 158.8 | 0.2 | 18.48 |
| 3 | 2.05 | 0.31 | 159.2 | 0.13 | 17.66 |
| 3.5 | 2.45 | 0.385 | 174.3 | 0.13 | 17.43 |
| 4 | 3.13 | 0.557 | -159 | 0.14 | 17.11 |
| 4.5 | 4.20 | 0.692 | -135.5 | 0.73 | 16.78 |
| 5 | 4.63 | 0.787 | -113.2 | 1.53 | 15.84 |
| 5.5 | 4.78 | 0.91 | -88 | 4.08 | 13.86 |
| 6 | 6.11 | 0.87 | -65.7 | 9.48 | 10.37 |

Note:

1. Measurements are made on 10mils Rogers RO4350 TRL Board.

Part Number Ordering Information

| Part Number | No. of Devices | Container |
|----------------|----------------|---------------|
| MGA-31289-BLKG | 100 | 7" Tape/Reel |
| MGA-31289-TR1G | 3000 | 13" Tape/Reel |

SOT89 Package Dimensions

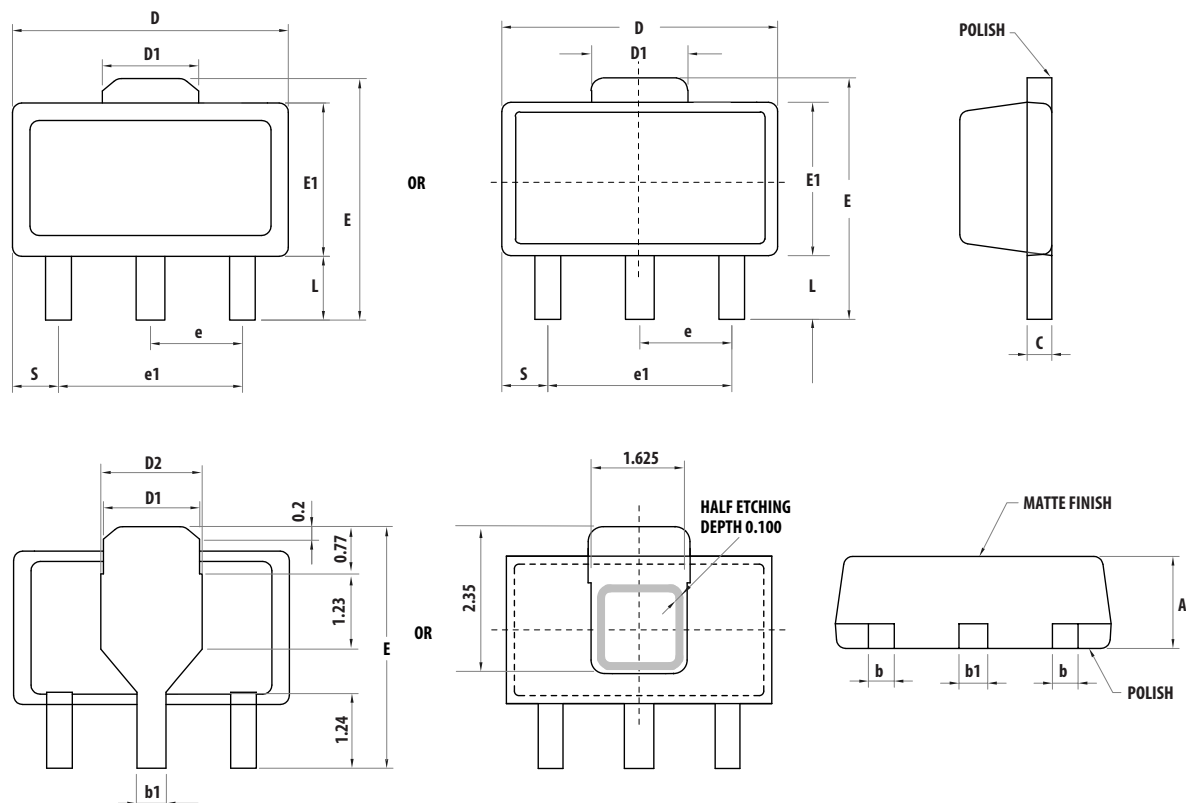

| Symbols | Dimensions in mm | | | Dimensions in inches | | |
|---------|------------------|---------|---------|----------------------|---------|---------|
| | Minimum | Nominal | Maximum | Minimum | Nominal | Maximum |
| A | 1.40 | 1.50 | 1.60 | 0.055 | 0.059 | 0.063 |
| L | 0.89 | 1.04 | 1.20 | 0.0350 | 0.041 | 0.047 |
| b | 0.36 | 0.42 | 0.48 | 0.014 | 0.016 | 0.018 |
| b1 | 0.41 | 0.47 | 0.53 | 0.016 | 0.018 | 0.030 |
| C | 0.38 | 0.40 | 0.43 | 0.014 | 0.015 | 0.017 |
| D | 4.40 | 4.50 | 4.60 | 0.173 | 0.177 | 0.181 |
| D1 | 1.40 | 1.60 | 1.75 | 0.055 | 0.062 | 0.069 |
| D2 | 1.45 | 1.65 | 1.80 | 0.055 | 0.062 | 0.069 |
| E | 3.94 | - | 4.25 | 0.155 | - | 0.167 |
| E1 | 2.40 | 2.50 | 2.60 | 0.094 | 0.098 | 0.102 |
| e1 | 2.90 | 3.00 | 3.10 | 0.114 | 0.118 | 0.122 |
| S | 0.65 | 0.75 | 0.85 | 0.026 | 0.030 | 0.034 |
| e | 1.40 | 1.50 | 1.60 | 0.054 | 0.059 | 0.063 |

Device Orientation

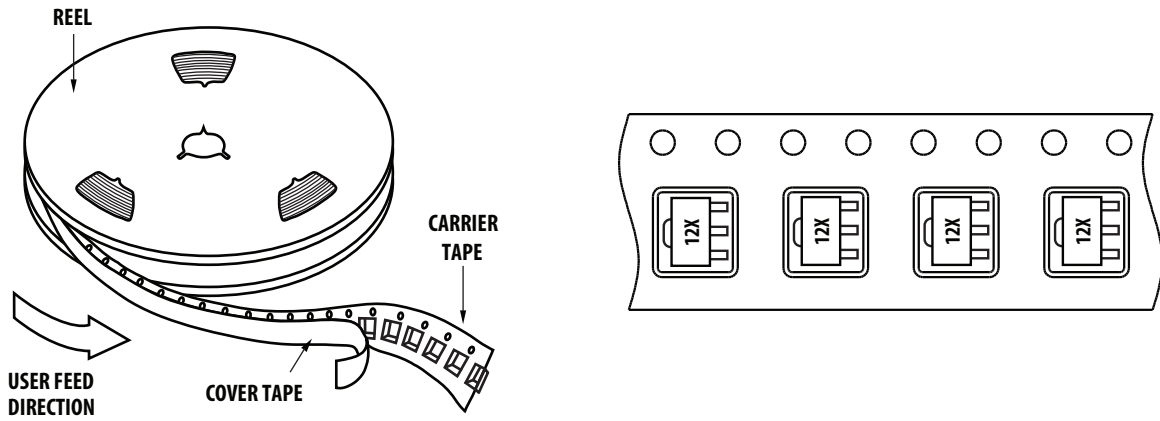

Tape Dimensions

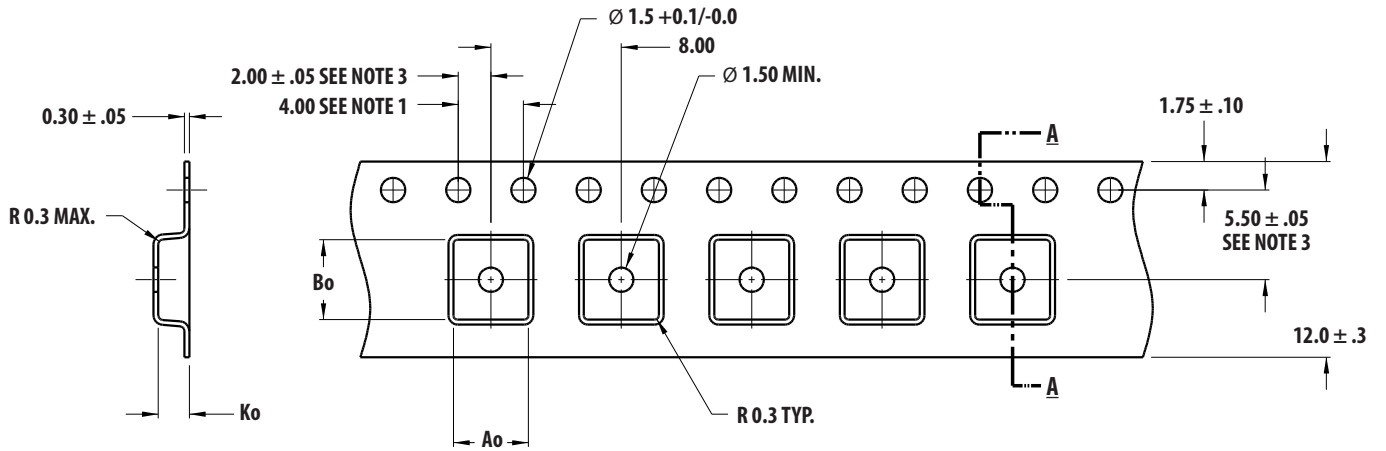

SECTION A - A

$\text{Ao} = 4.60$
 $\text{Bo} = 4.90$
 $\text{Ko} = 1.90$

DIMENSIONS IN MM

NOTES:

1. 10 SPROCKET HOLE PITCH CUMULATIVE TOLERANCE ± 0.2
2. CAMBER IN COMPLIANCE WITH EIA 481
3. POCKET POSITION RELATIVE TO SPROCKET HOLE MEASURED AS TRUE POSITION OF POCKET, NOT POCKET HOLE

Reel Dimensions – 13" Reel

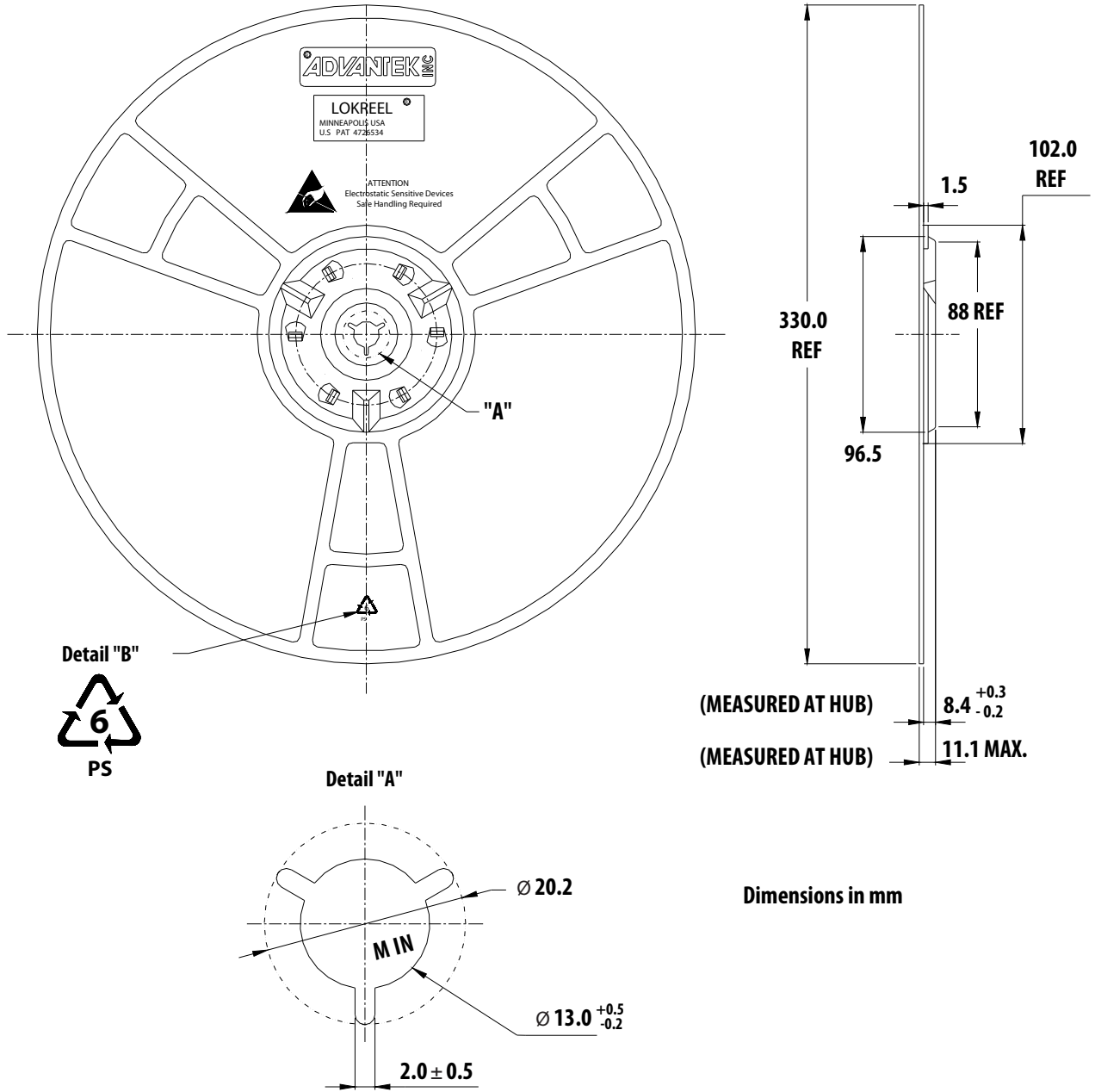

For product information and a complete list of distributors, please go to our web site: www.avagotech.com

Avago, Avago Technologies, and the A logo are trademarks of Avago Technologies in the United States and other countries. Data subject to change. Copyright © 2005-2013 Avago Technologies. All rights reserved. AV02-2533EN - November 11, 2013

